

PARIS P13

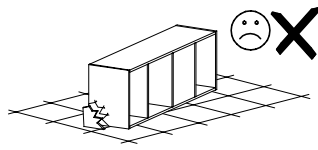

Narzędzia potrzebne do montażu

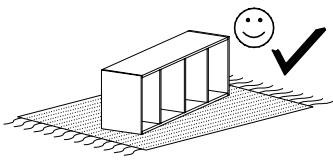
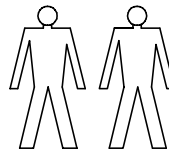
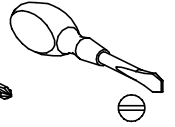
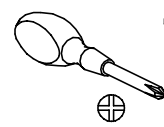
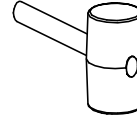
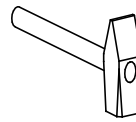

UWAGA !!
MONTOWANIE USZKODZONYCH
ELEMENTÓW POWODUJE UTRATĘ
GWARANCJI

nr	D[mm]	S[mm]	G[mm]	Ilość
1	800	320	16	1
2	800	160	48	1

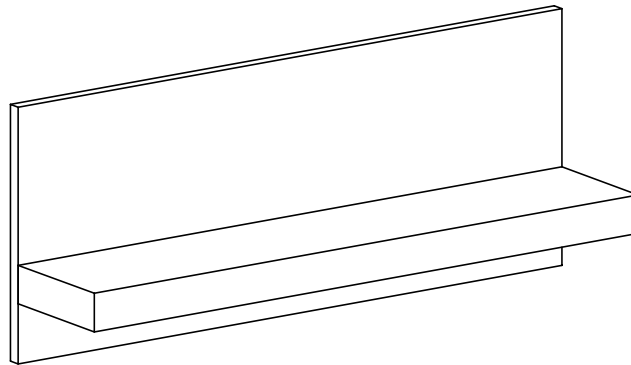

W przypadku reklamacji proszę o podanie numeru pakowacza znajdującego się na kartonie

Z - 1 St.

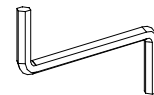

A - 3 St.

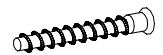

1

