

# INDIANA

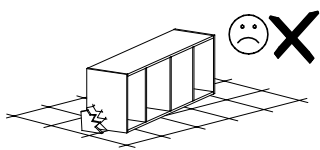

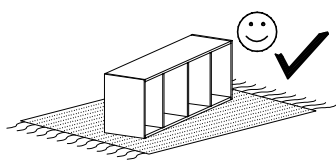

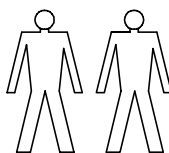

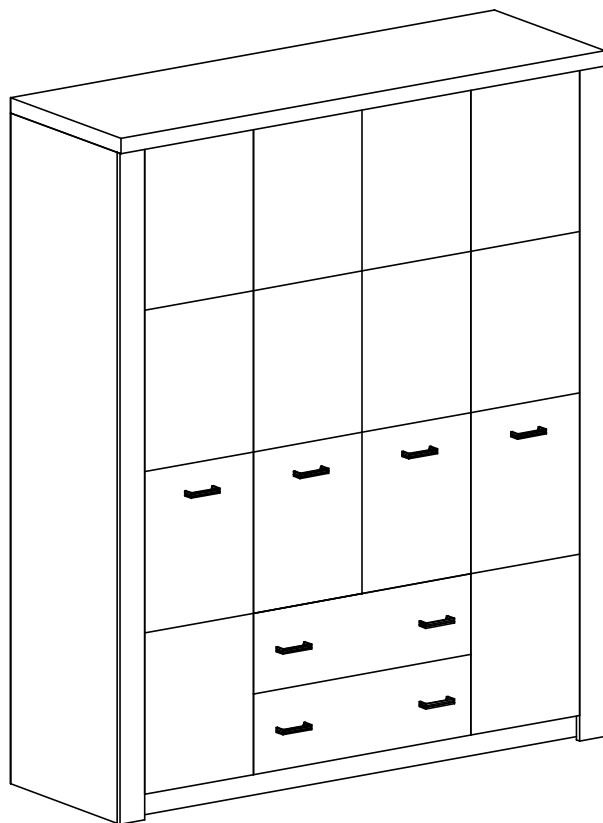
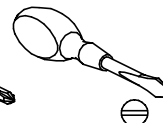
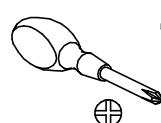
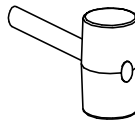
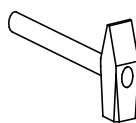



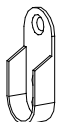
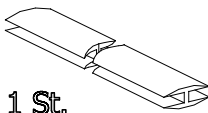

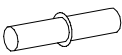
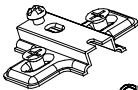
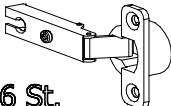
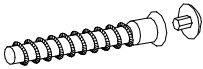
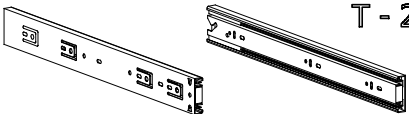
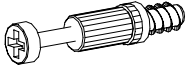

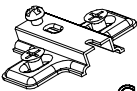
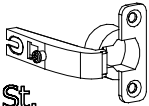
# I-18

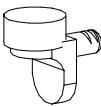

Narzędzia potrzebne do montażu

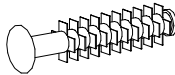
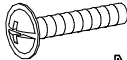

W przypadku reklamacji proszę o podanie numeru pakowacza znajdującego się na kartonie

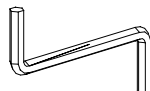
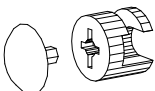
			 I - 10 St.	 Z - 6 St.
 H - 1 St.	 Y - 20 St.	 W - 20 St.	 C2 - 6 St.	 D2 - 6 St.
 A - 10 St.	 T - 2 Kpl.		 K - 26 St.	 M - 38 St. 3 x 30 mm
 C1 - 8 St.	 D1 - 8 St.	 R - 2 St.	 F - 1 St.	 J - 16 St. 5 x 13 mm
 S - 2 St.	 KLEJ Ł - 1 St.	 U - 8 St.	 P - 8 St.	 N - 16 St. M4 x 25 mm
 E - 90 St.	 B - 42 St.	 G - 40 St. 3,5 x 16 mm	 O - 1 St.	 L - 26 St.

I

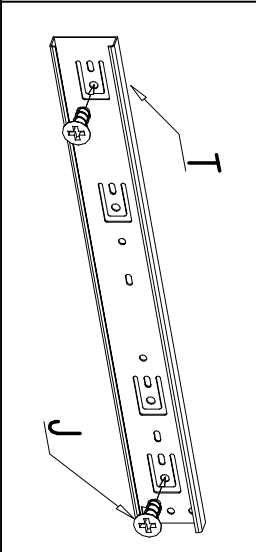
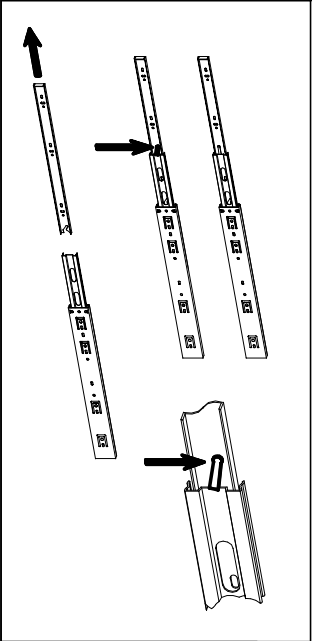
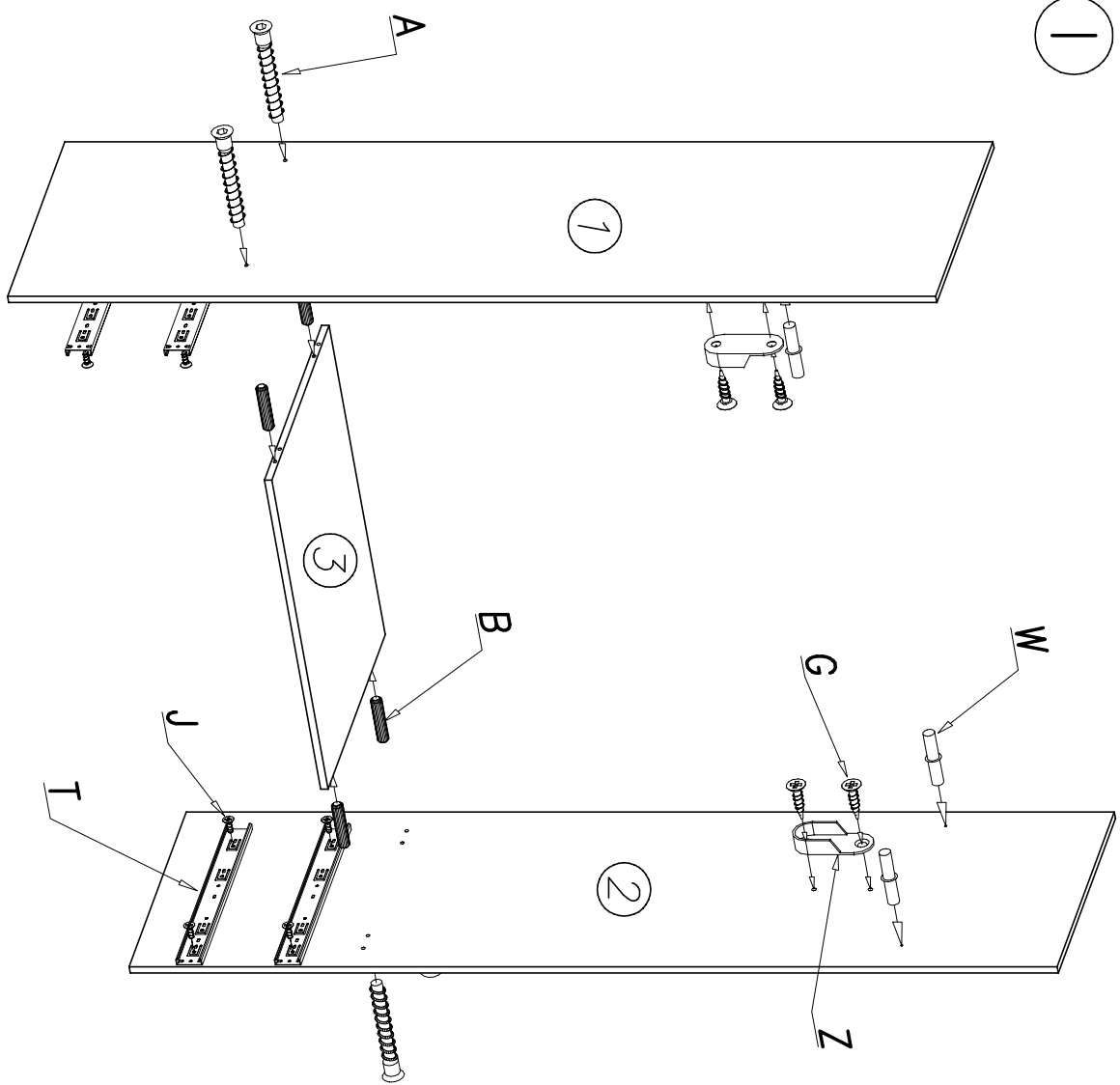

II

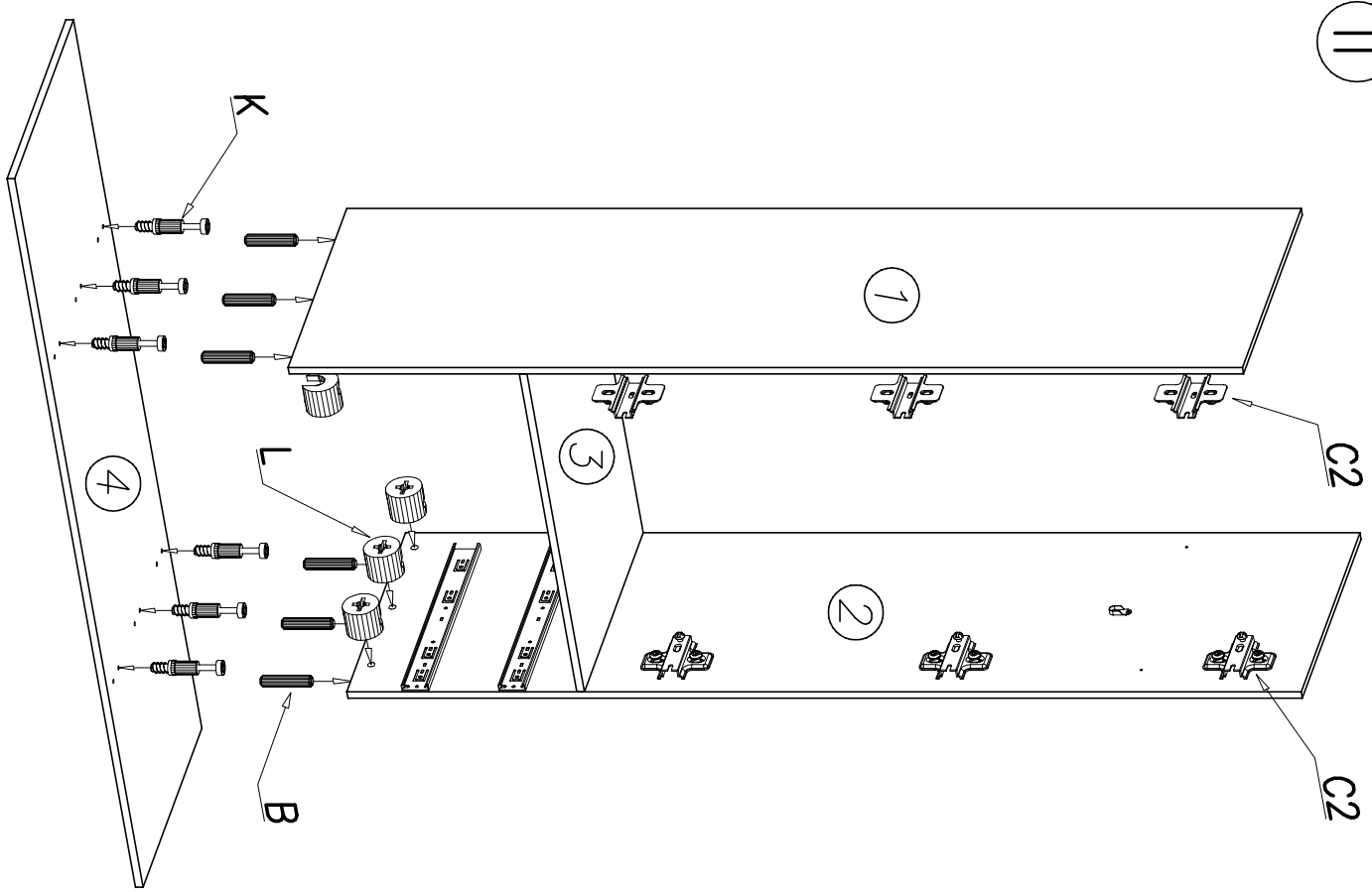

III

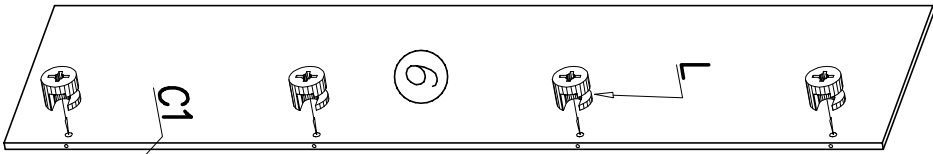
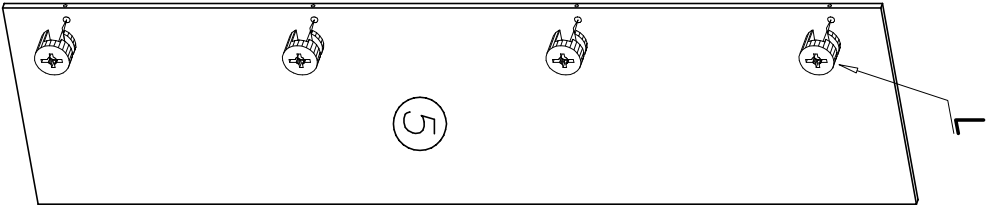
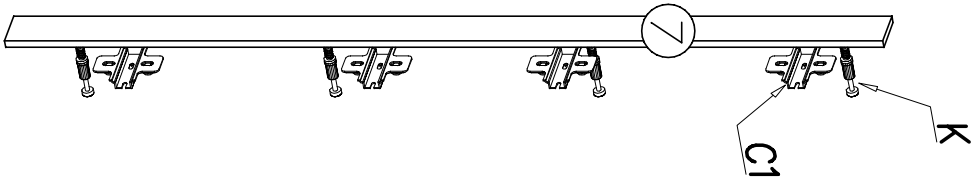

IV

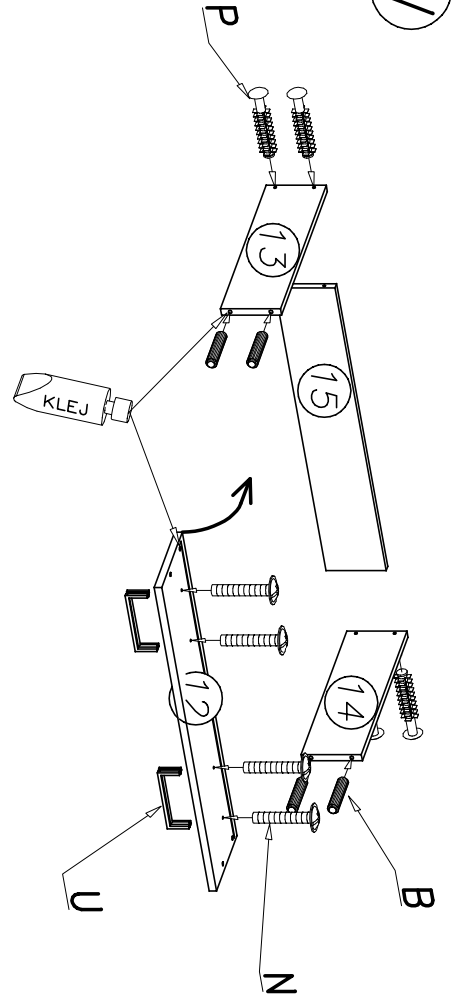
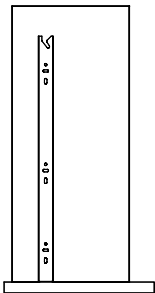
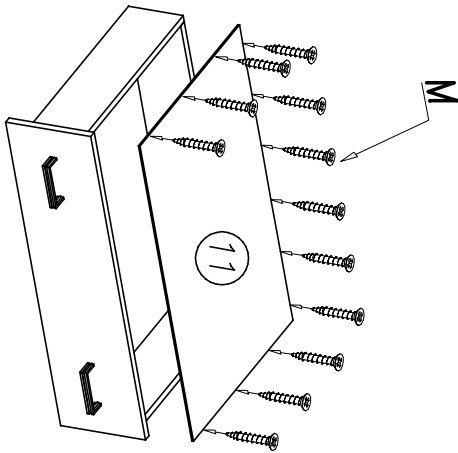
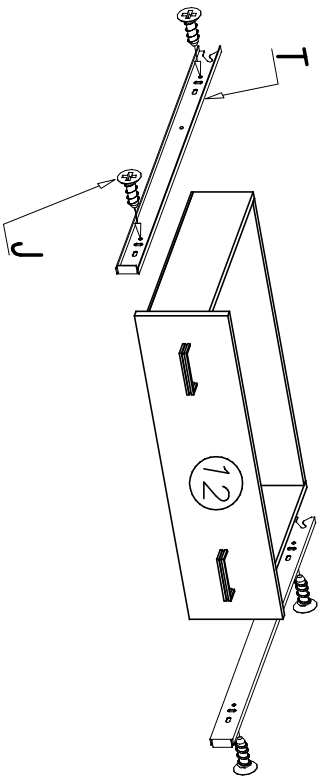

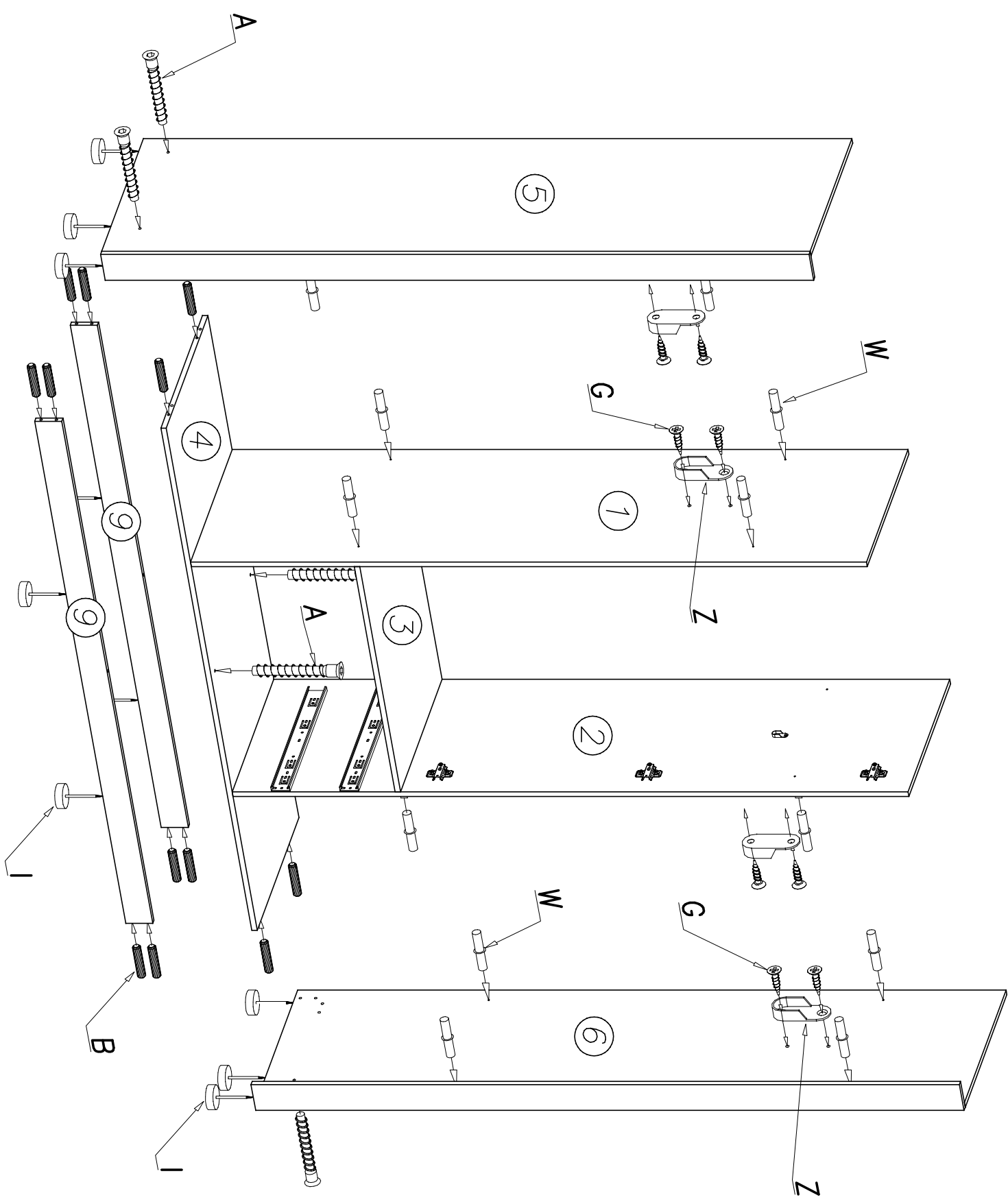

VI

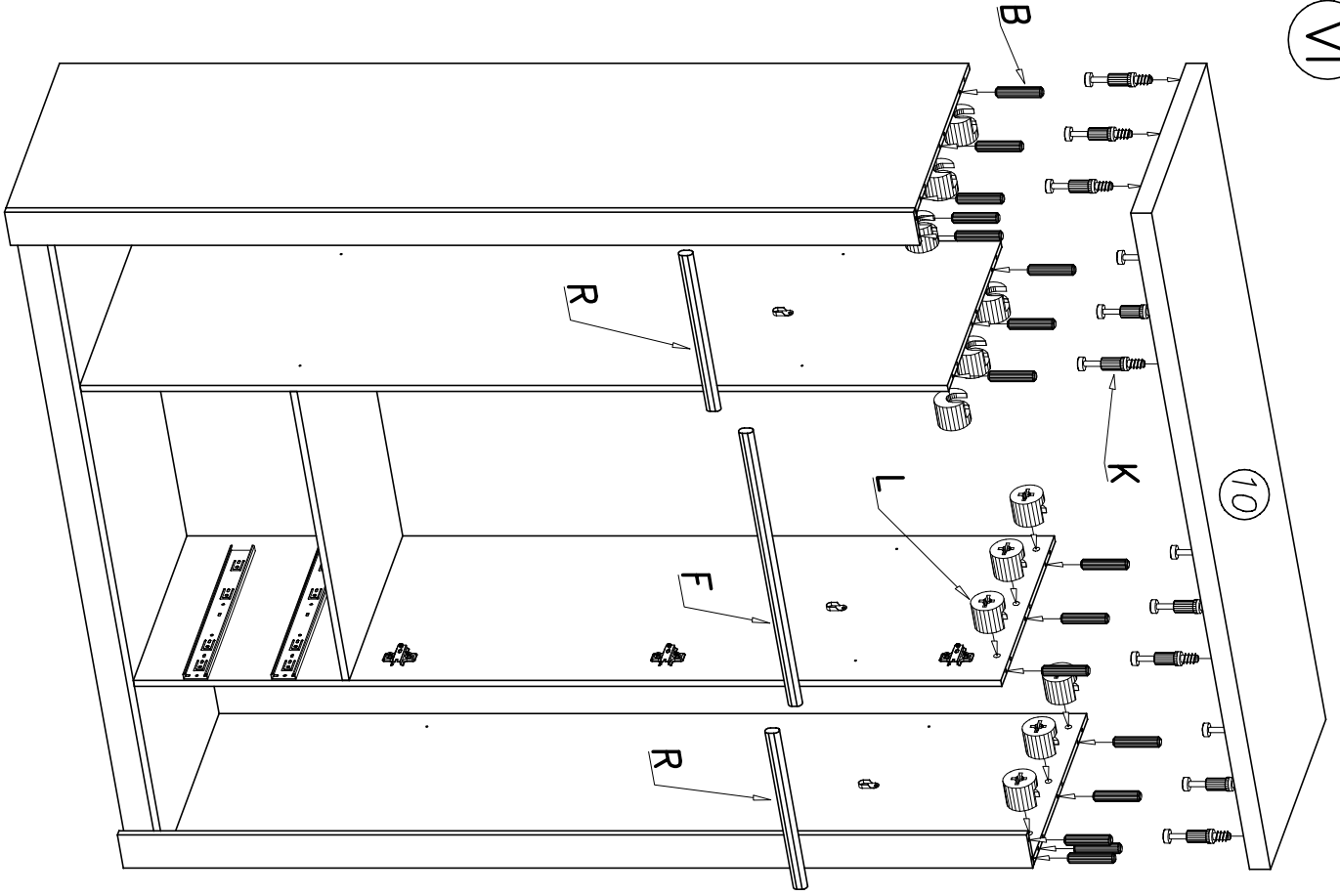

VII

