

INDIANA

1-5

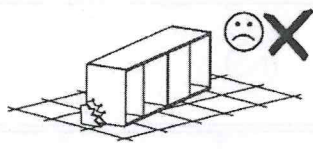

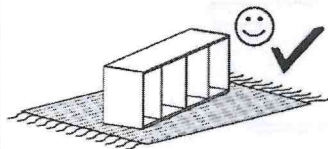

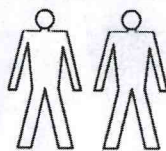
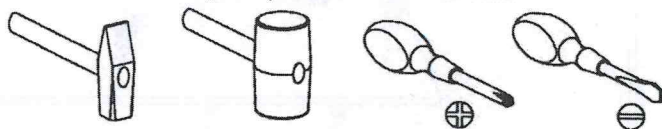



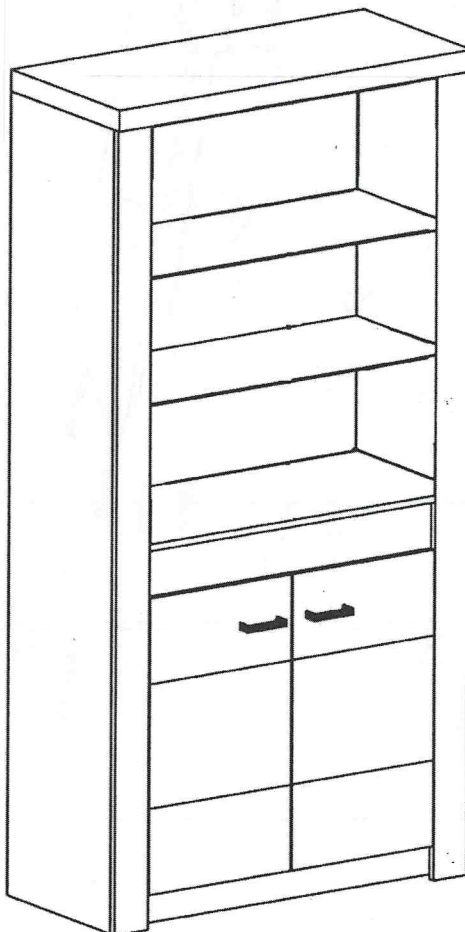

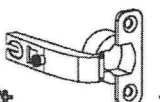
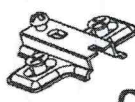
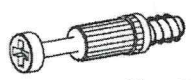

Narzędzia potrzebne do montażu

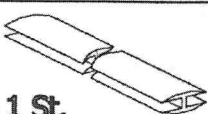

UWAGA!
MONTOWANIE USZKODZONYCH
ELEMENTÓW POWODUJE UTRATĘ
GWARANCJI

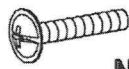

W przypadku reklamacji proszę o podanie numeru pakowacza znajdującego się na kartonie

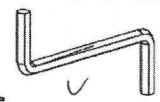
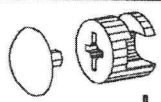
	 D - 4 St.	 C - 4 St.	 K - 12 St.	 P - 12 St.
 H - 1 St.	 KLEJ Z - 1 St.	 U - 2 St.	 A - 8 St.	 N - 4 St. M4 x 25 mm
 E - 50 St.	 B - 24 St.	 G - 8 St. 3,5 x 16 mm	 Z - 1 St.	 L - 12 St.

1

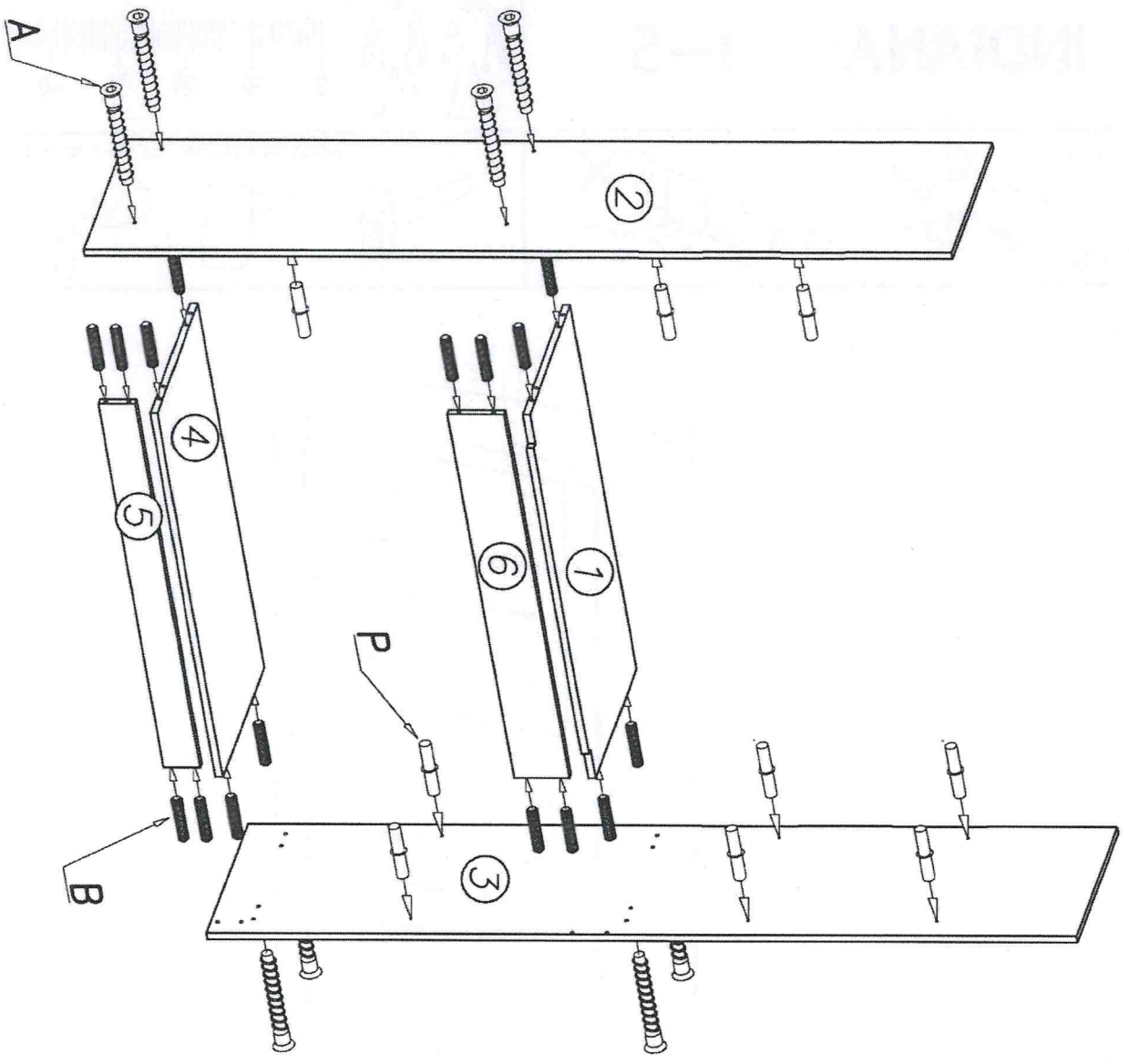

II

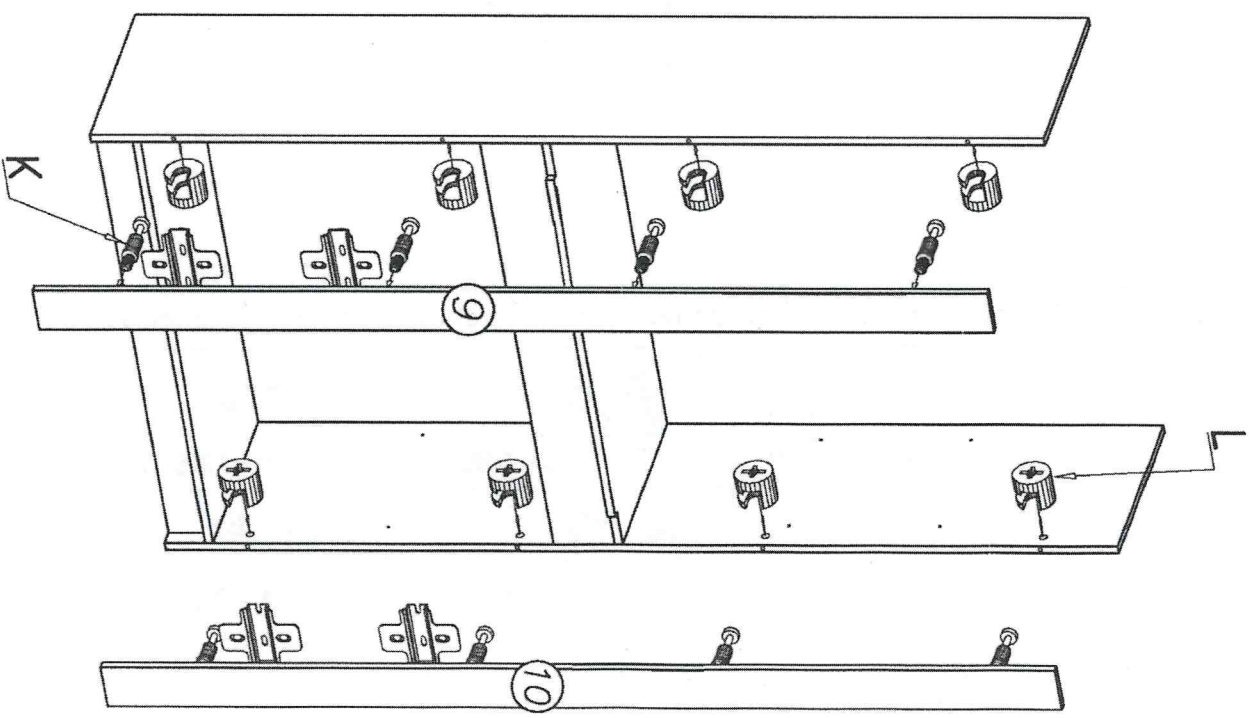

III

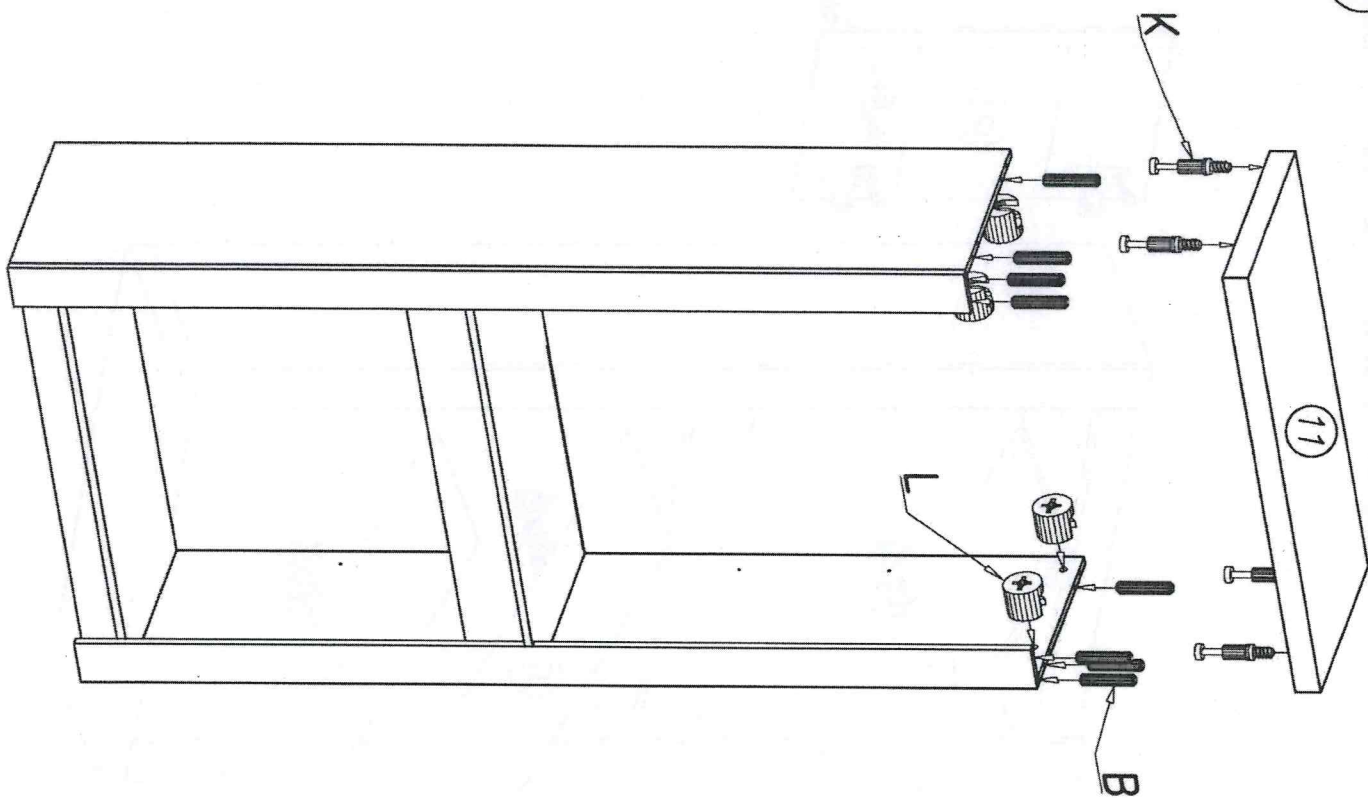

IV

