

OPTIMAL 19

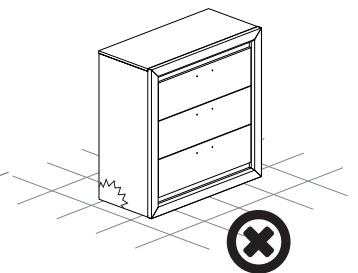

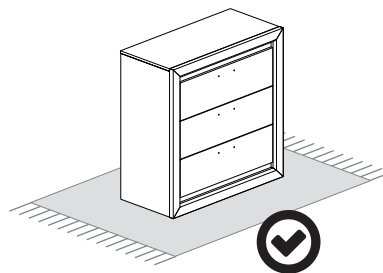

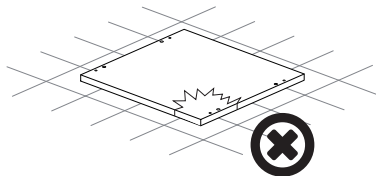

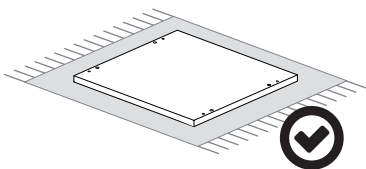
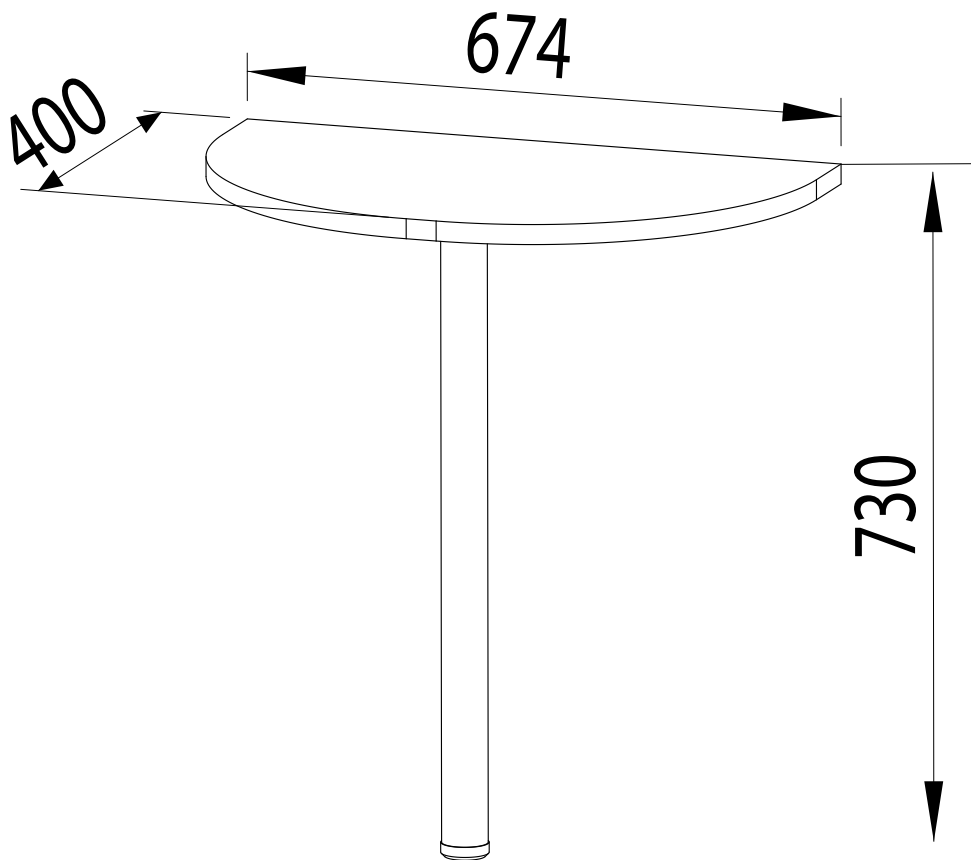
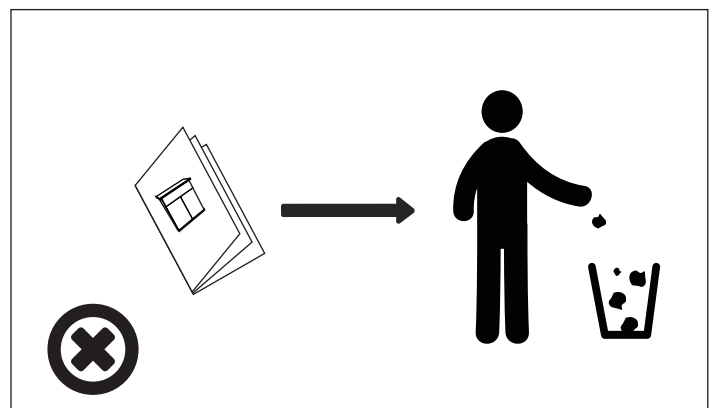
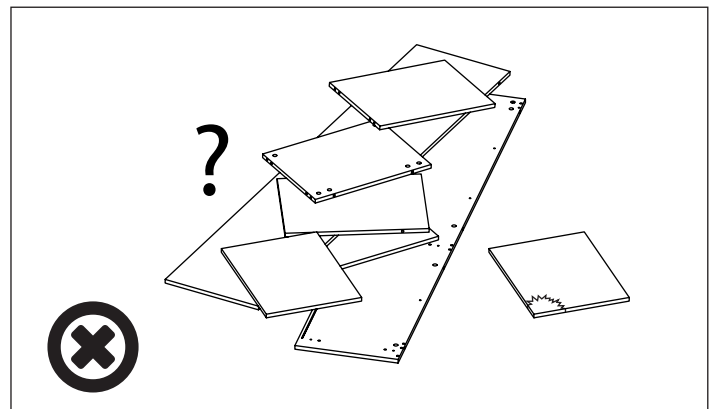
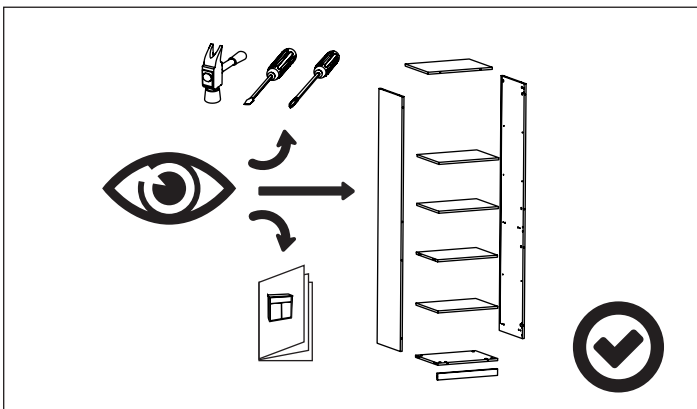
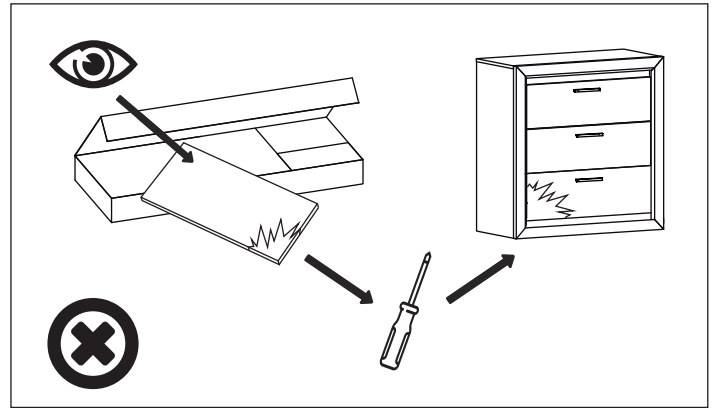
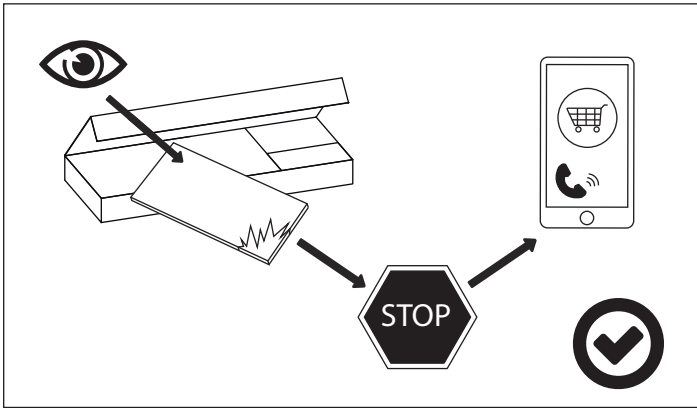
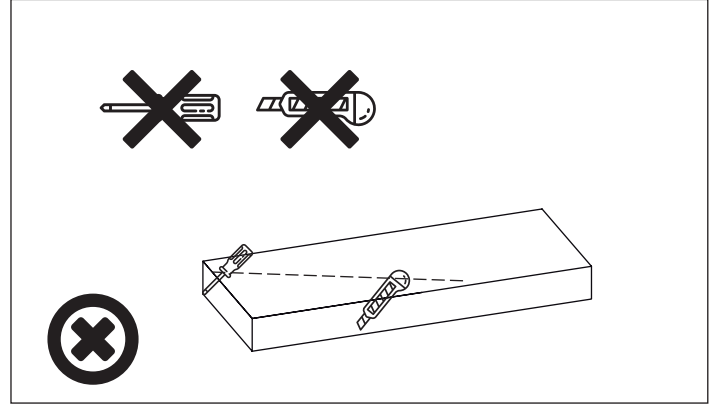
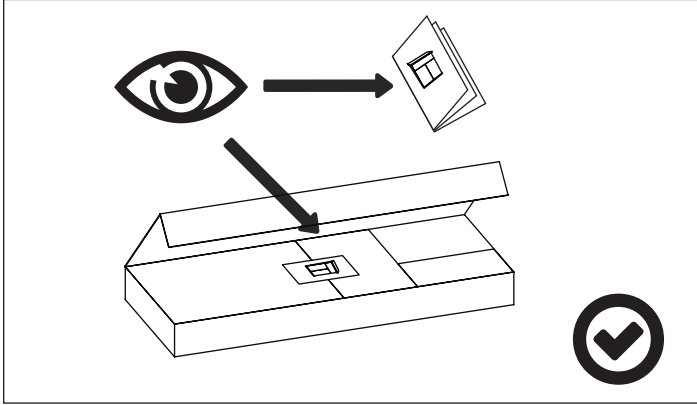
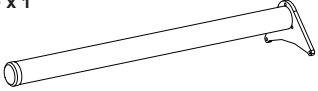
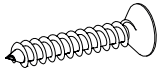
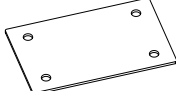
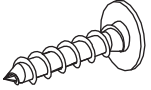

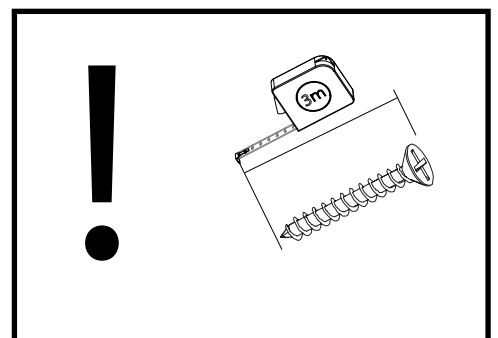
OPTIMAL 19

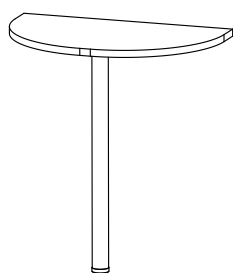
<p>NS1 x 1</p> 	<p>WT34 x 5</p> 	<p>PM1 x 2</p> 
<p>WT2 x 8</p> 		





	CODE			
①	OPTIMAL19_01	674	400	1
②				
③				
④				
⑤				
⑥				

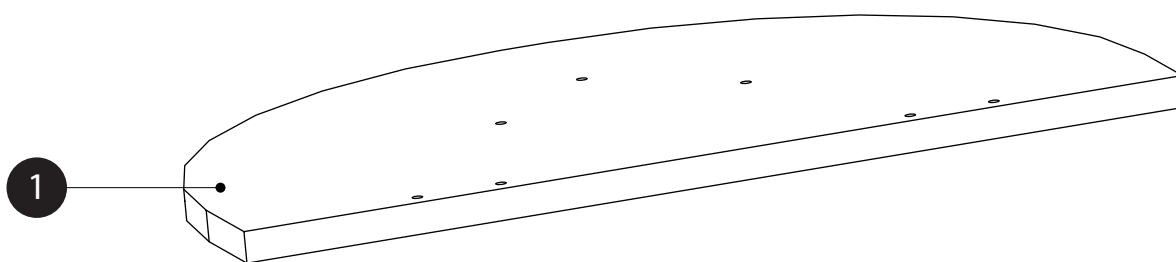

A ▶

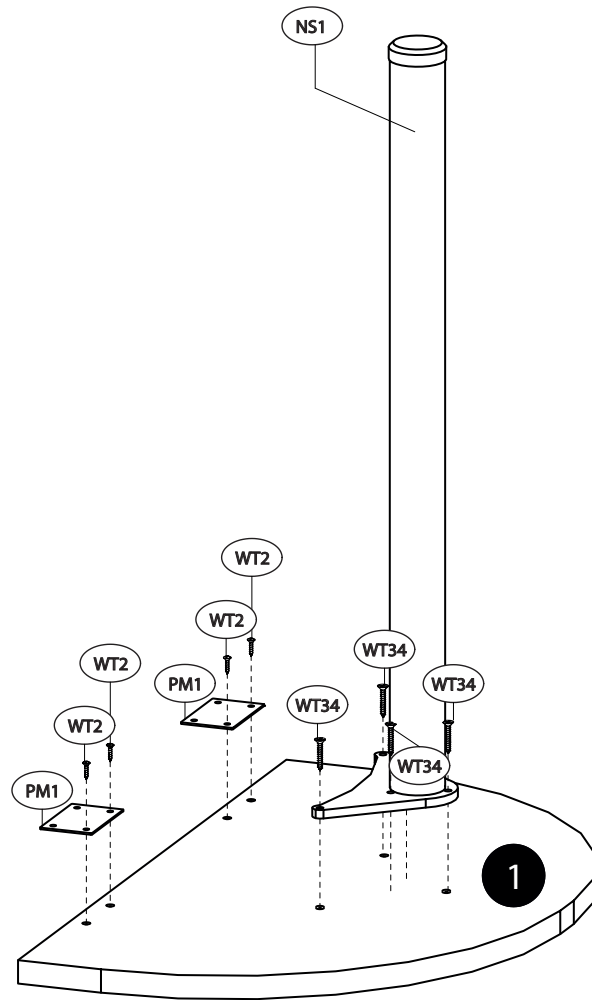

B ▶

