

# NATURAL 14

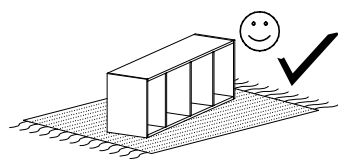

Narzędzia potrzebne do montażu

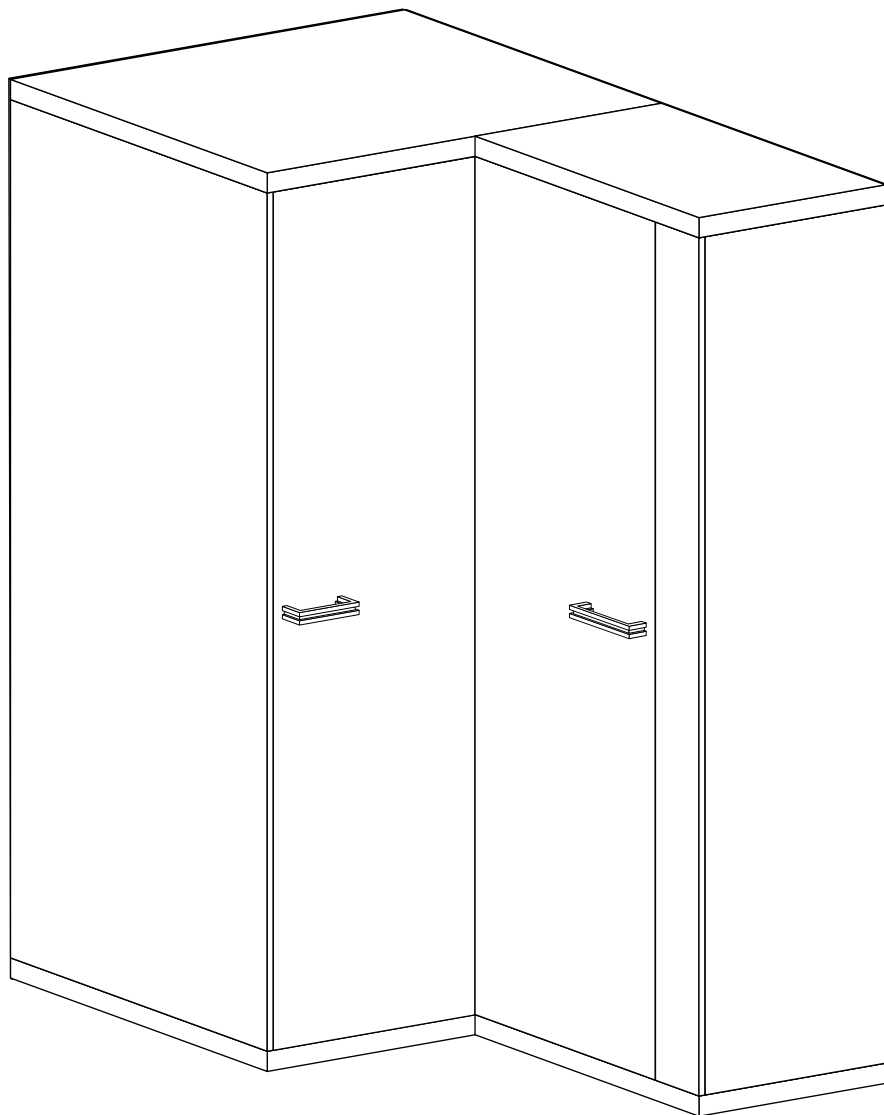
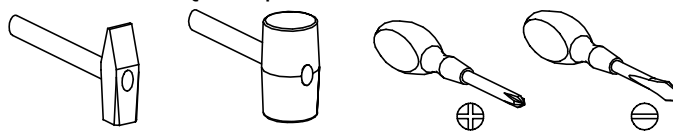

Nr	D[mm]	S[mm]	G[mm]	Ilość
1	1900	538	16	1
2	1900	389	16	1
3	872	538	48	1
4	552	406	16	1
5	872	538	48	1
6	552	406	48	1
7	1900	405	16	1
8	1900	400	16	1
9	840	120	16	1
10	1900	100	16	1
11	840	400	16	1
12	536	320	48	4
13	1950	430	2,5	2
14	1950	360	2,5	2
15	1894	445	16	2

### UWAGA !!!

MONTOWANIE USZKODZONYCH  
ELEMENTÓW POWODUJE UTRATĘ  
GWARANCJI

W przypadku reklamacji proszę podać numer pakowacza znajdujący się na kartonie.

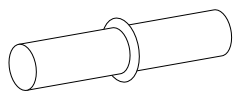

**B - 20 St.**



**A - 2 St.**

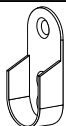

**R - 2 St.**

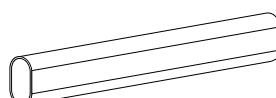

**S - 1 St.**

**UWAGA !!!**  
Mebel zawiera  
elementy drewniane

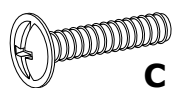

**C - 4 St.**  
4x25 mm

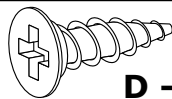

**D - 35 St.**  
3,5x16 mm

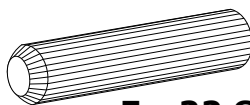

**E - 22 St.**

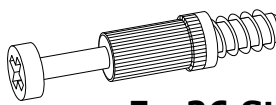

**F - 26 St.**

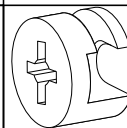

**G - 31 St.**

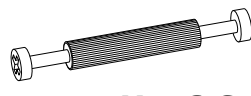

**H - 6 St.**

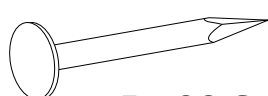

**I - 90 St.**

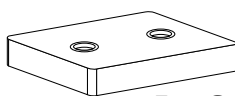

**J - 8 St.**

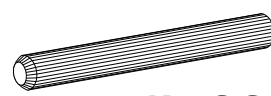

**K - 6 St.**

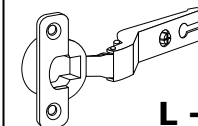

**L - 4 St.**

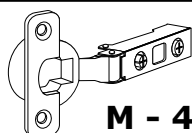

**M - 4 St.**

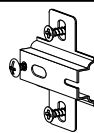

**N - 8 St.**

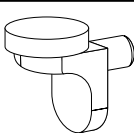

**O - 2 St.**

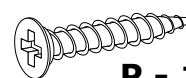

**P - 16 St.**  
3,5x25 mm

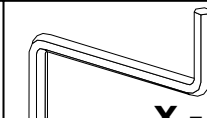

**X - 1 St.**

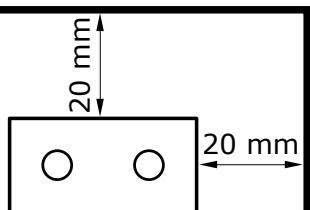
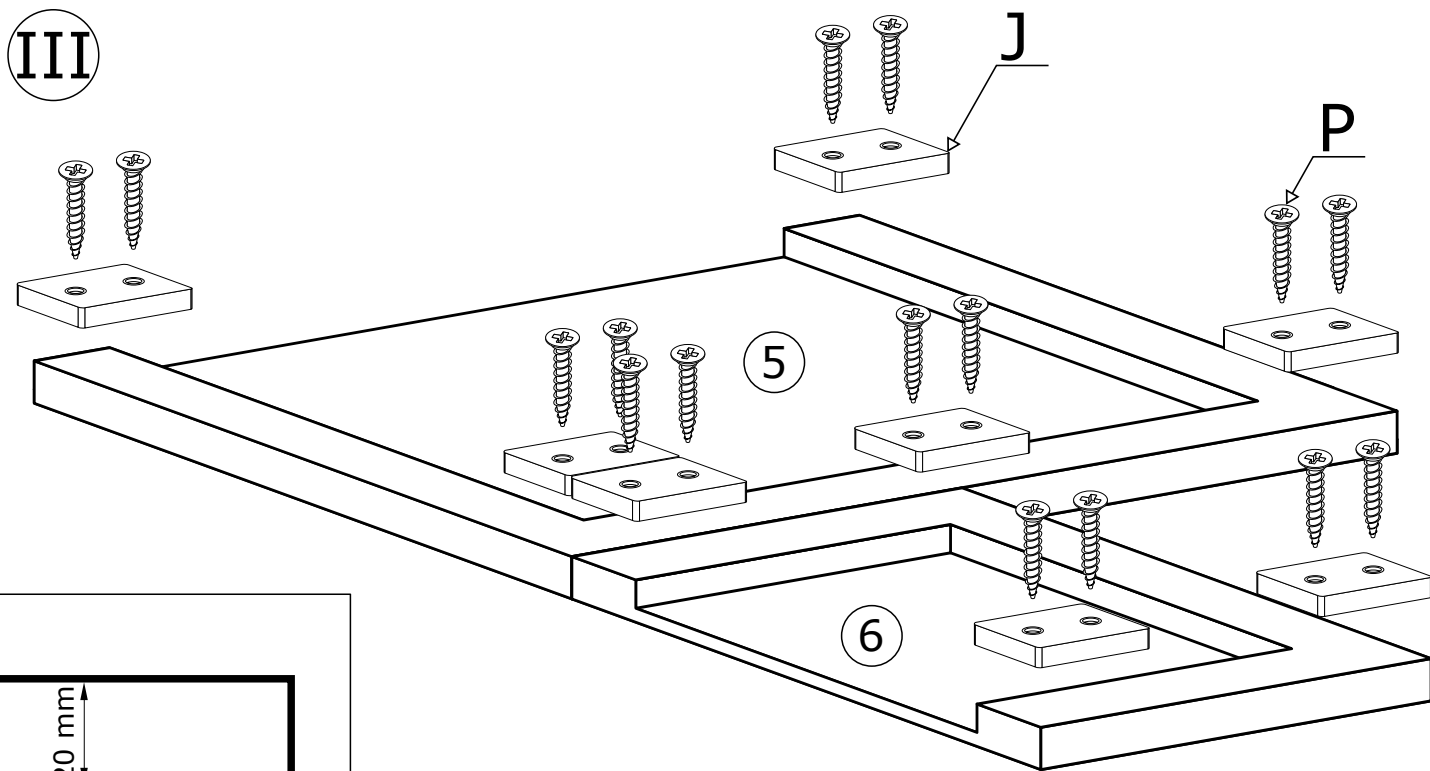
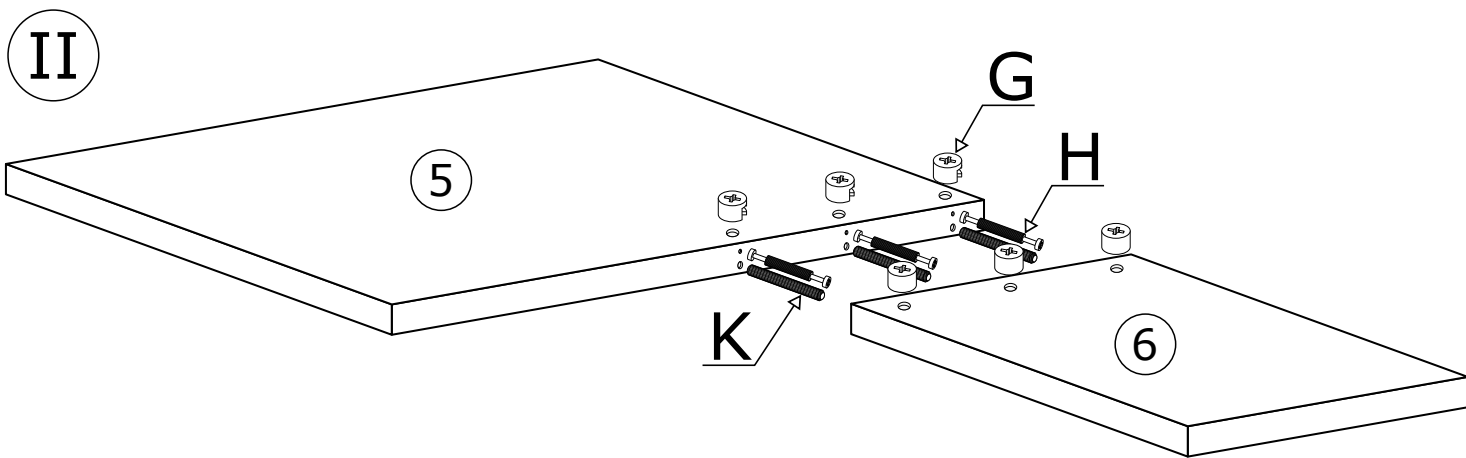
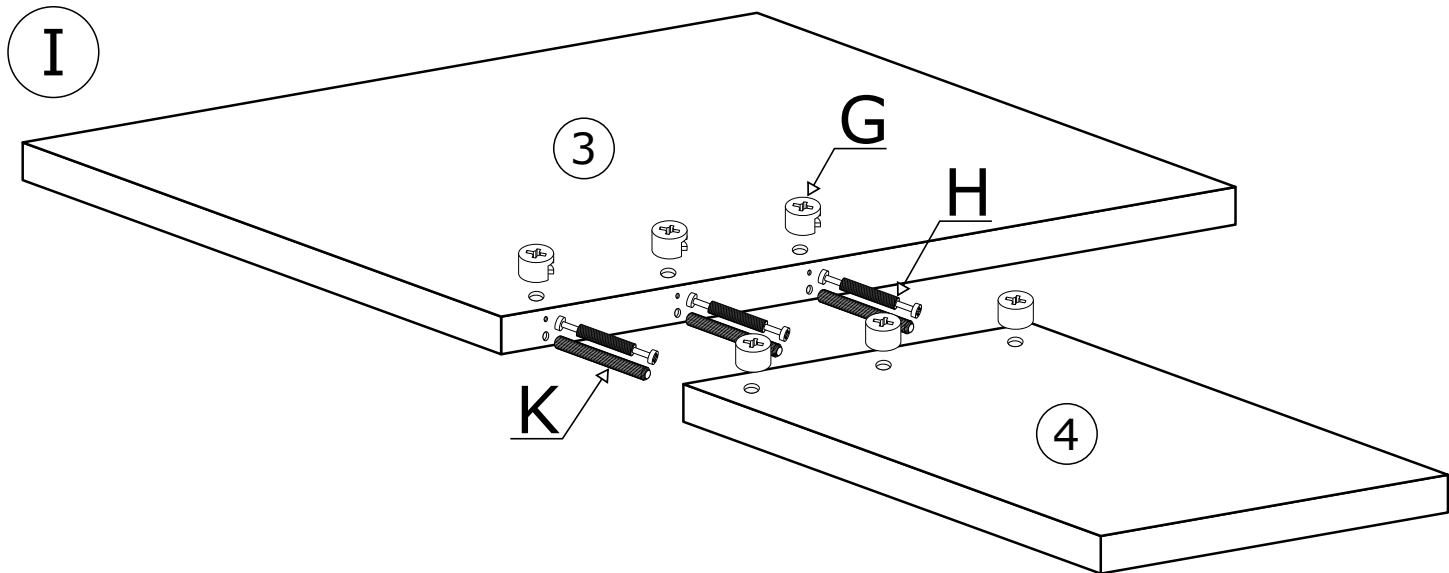

IV

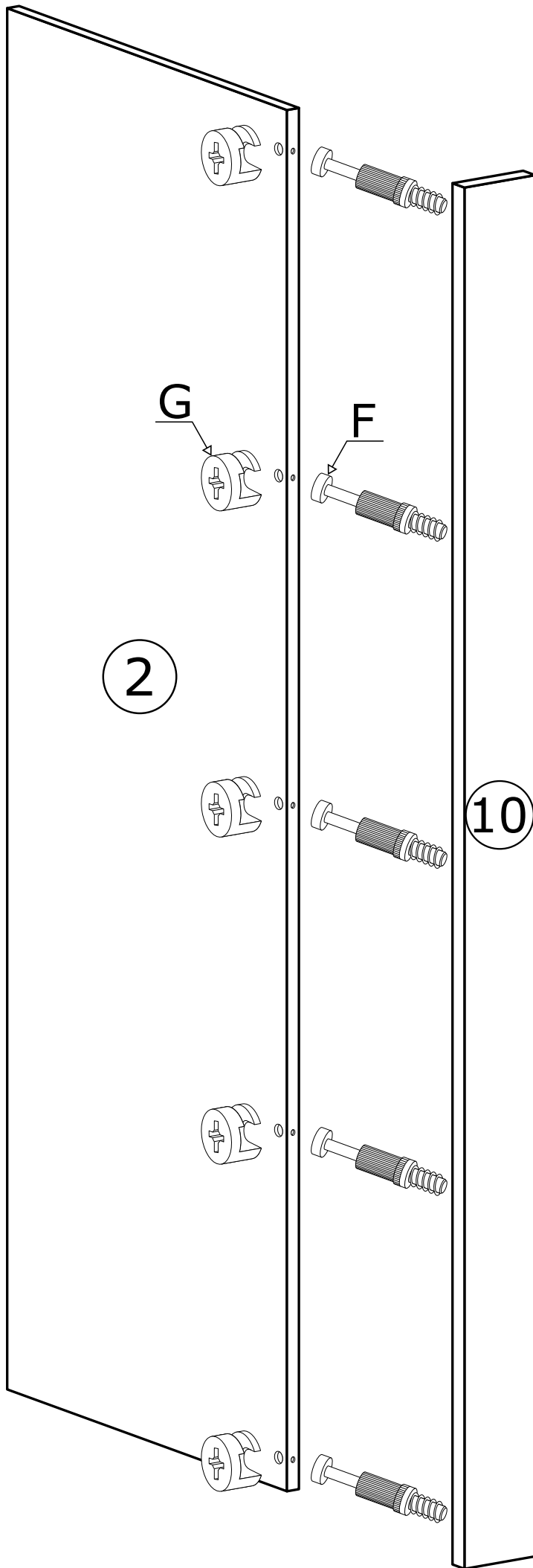

V

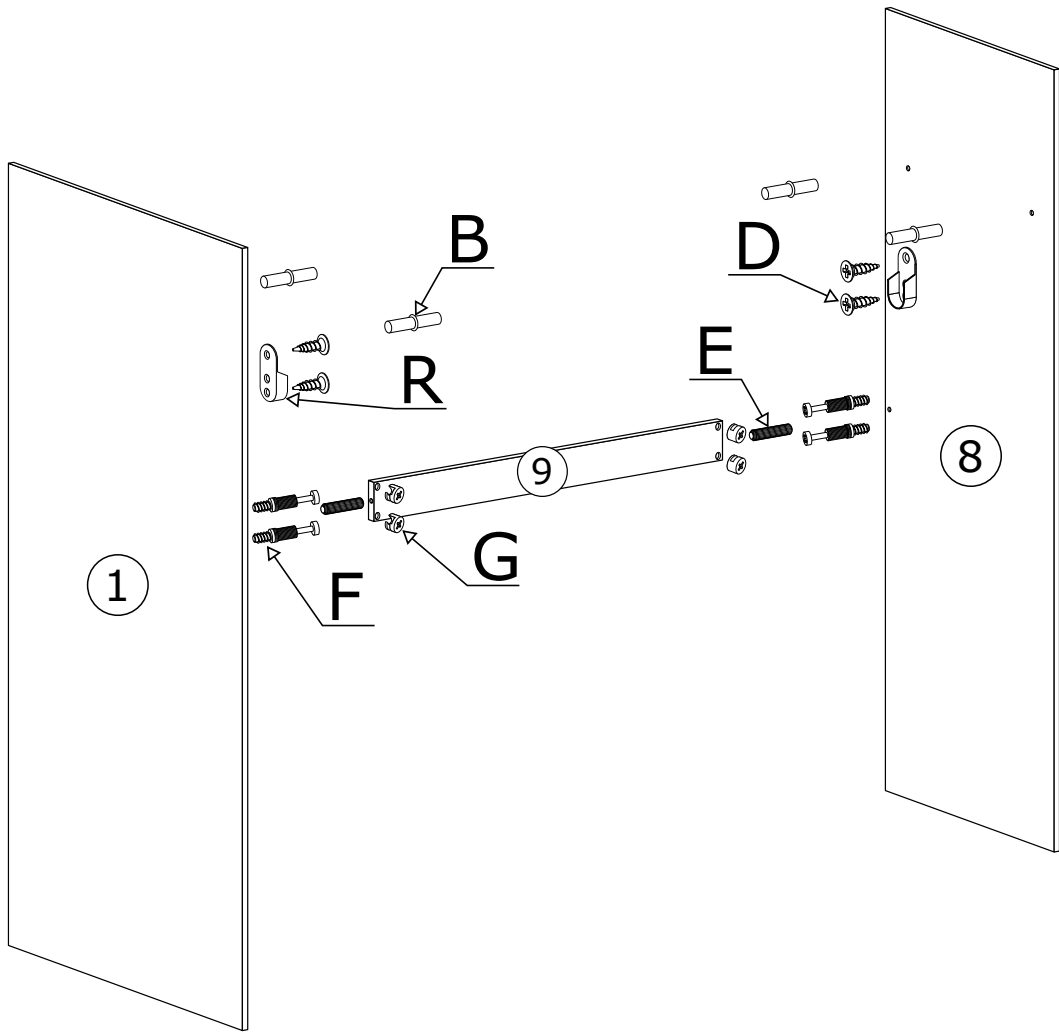

VI

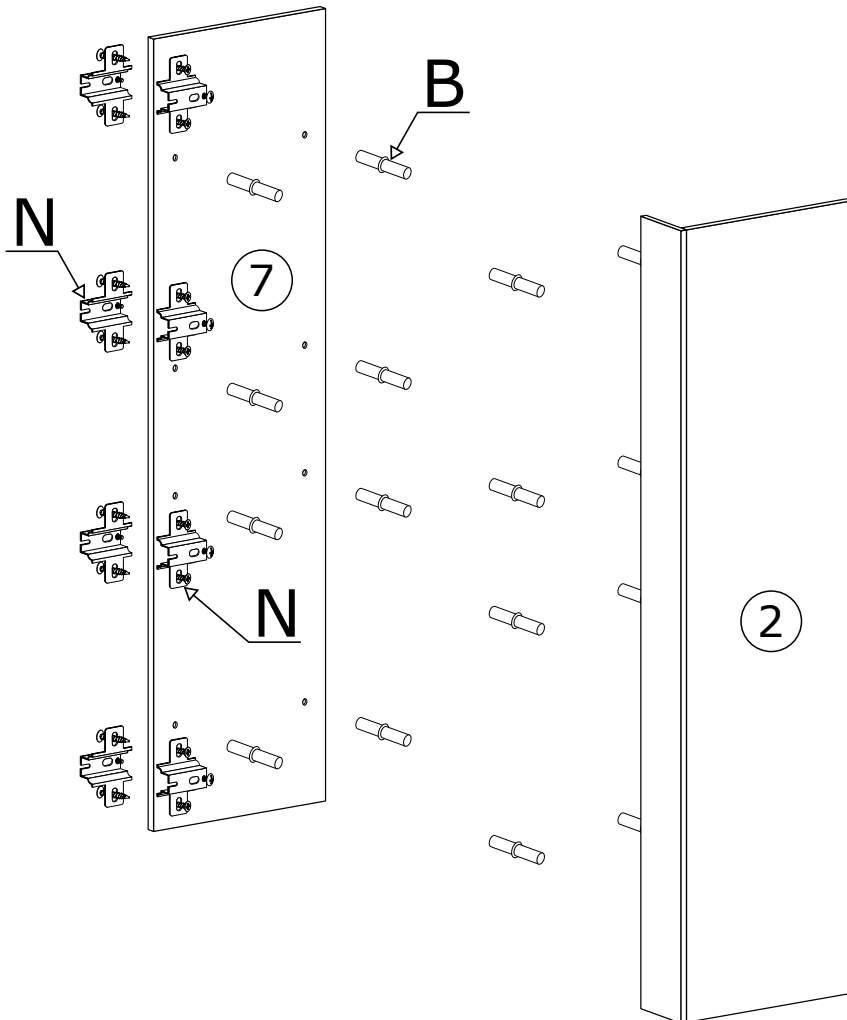

VII

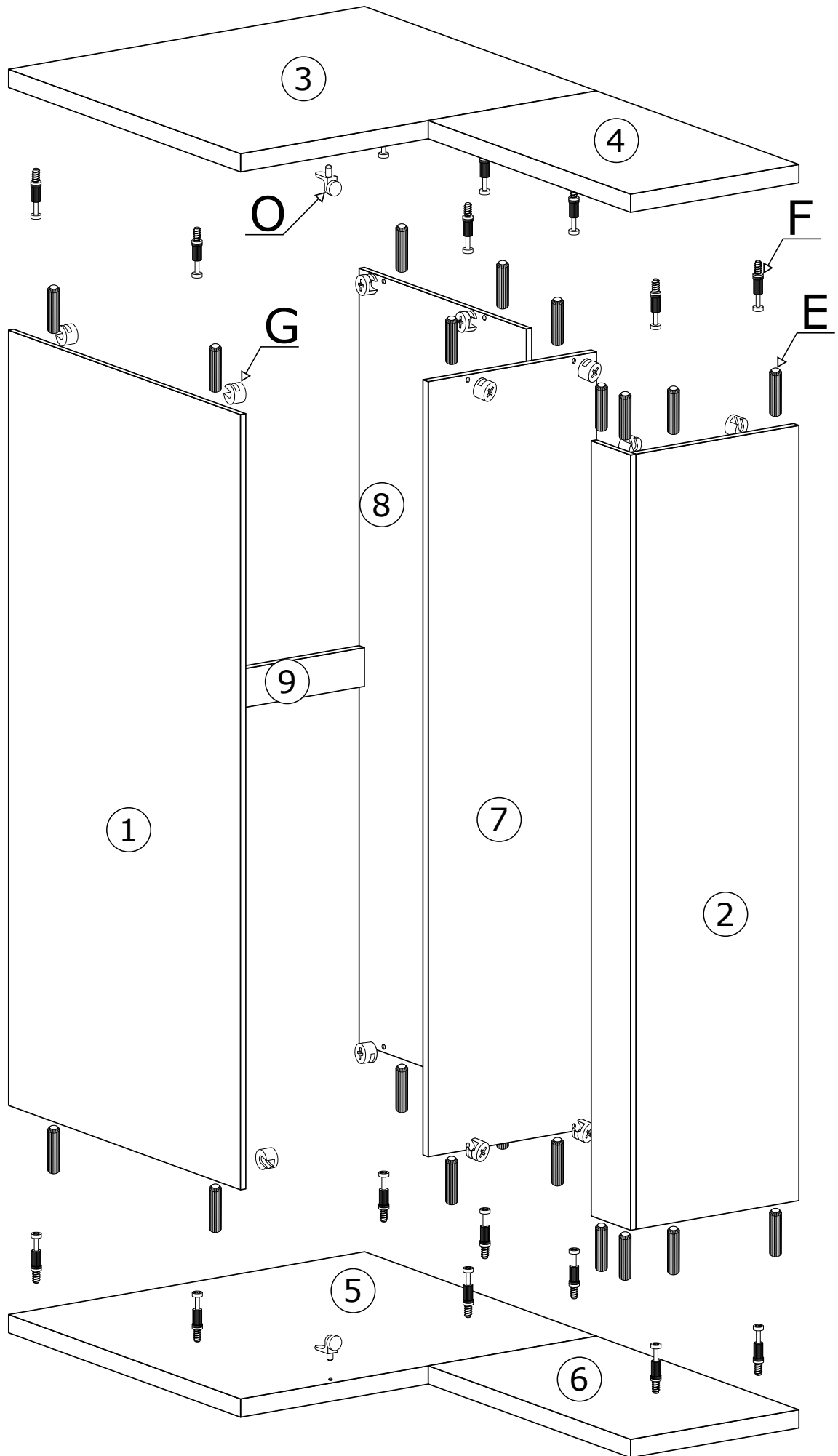

VIII

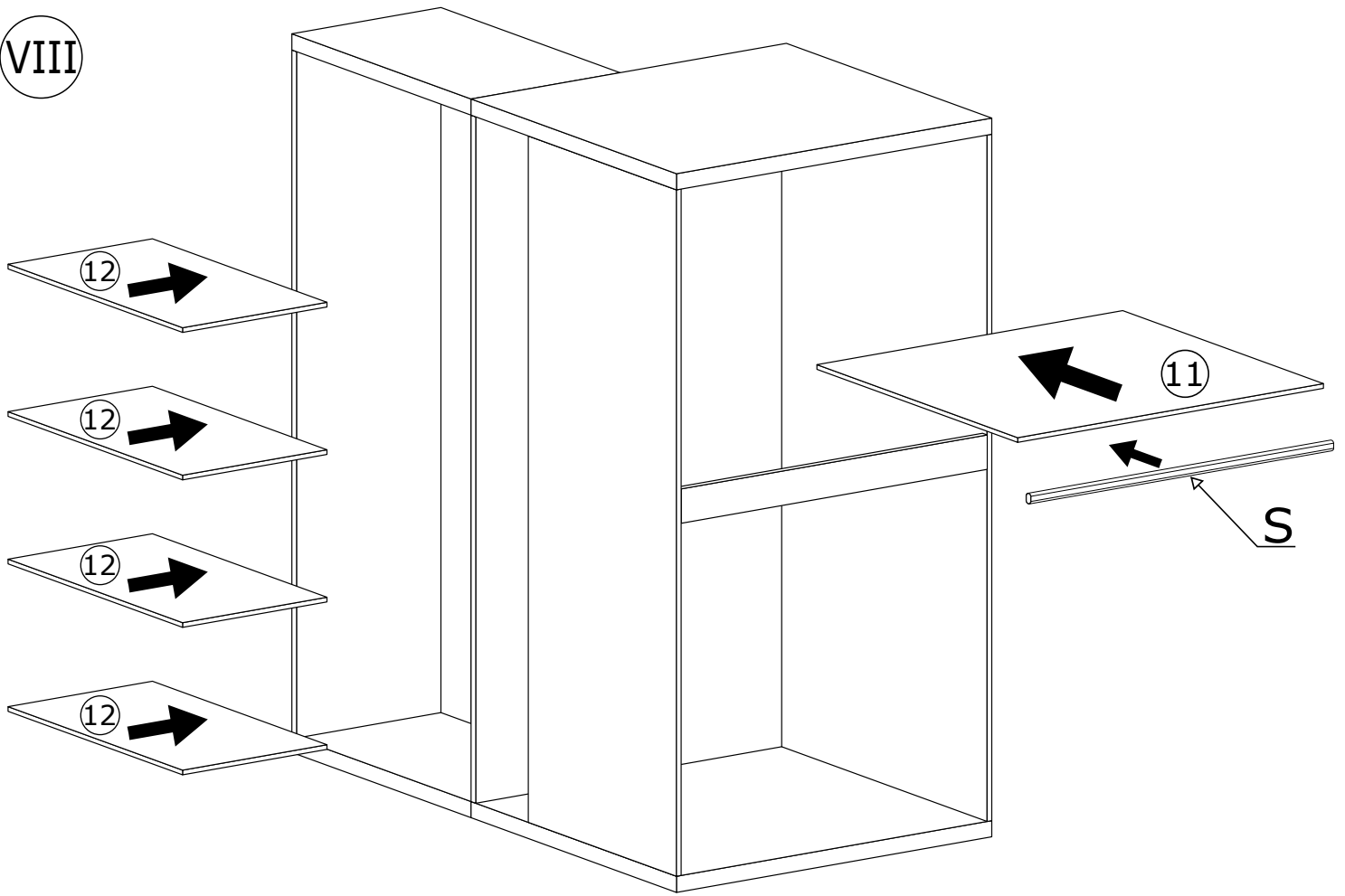

IX

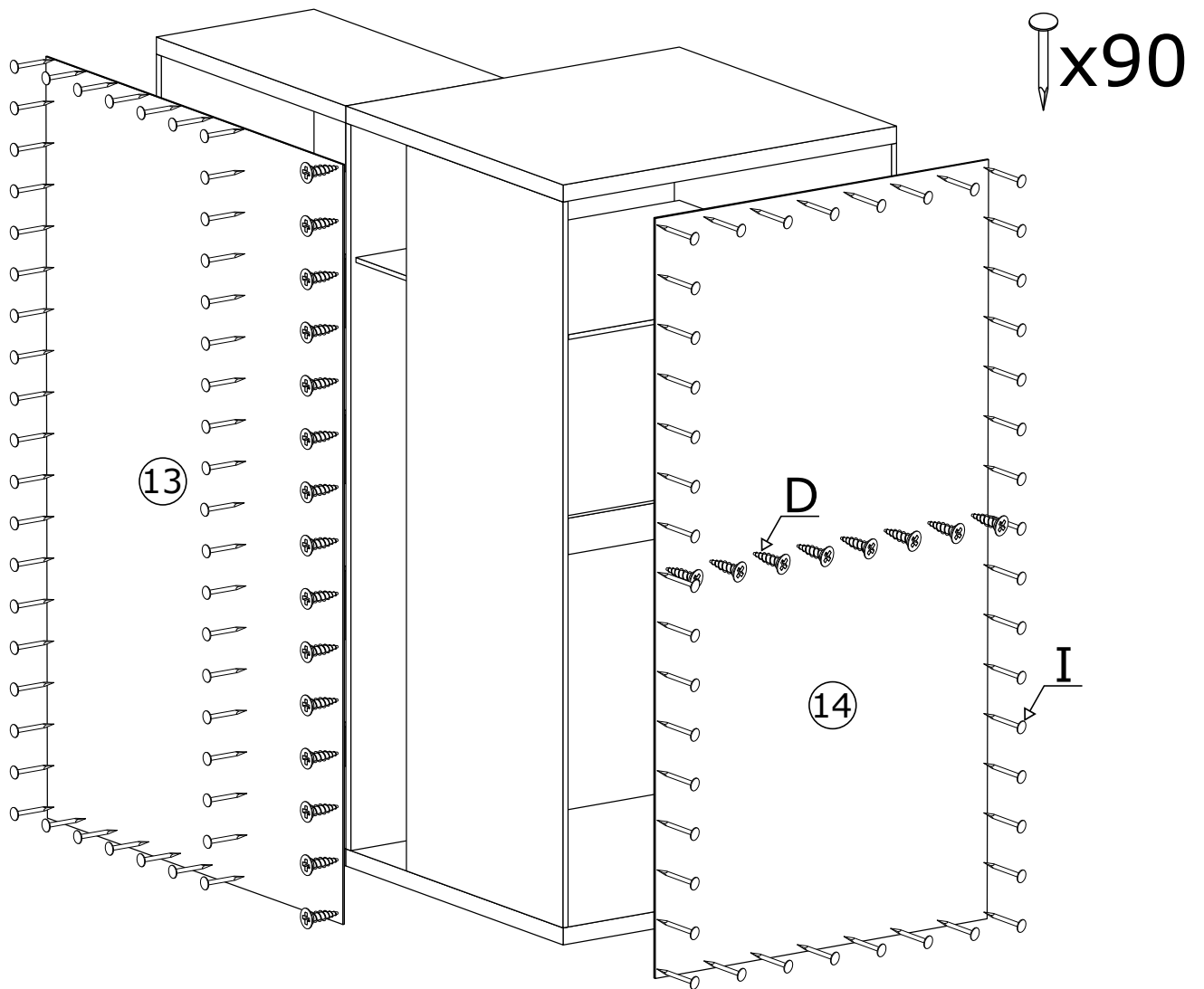

X

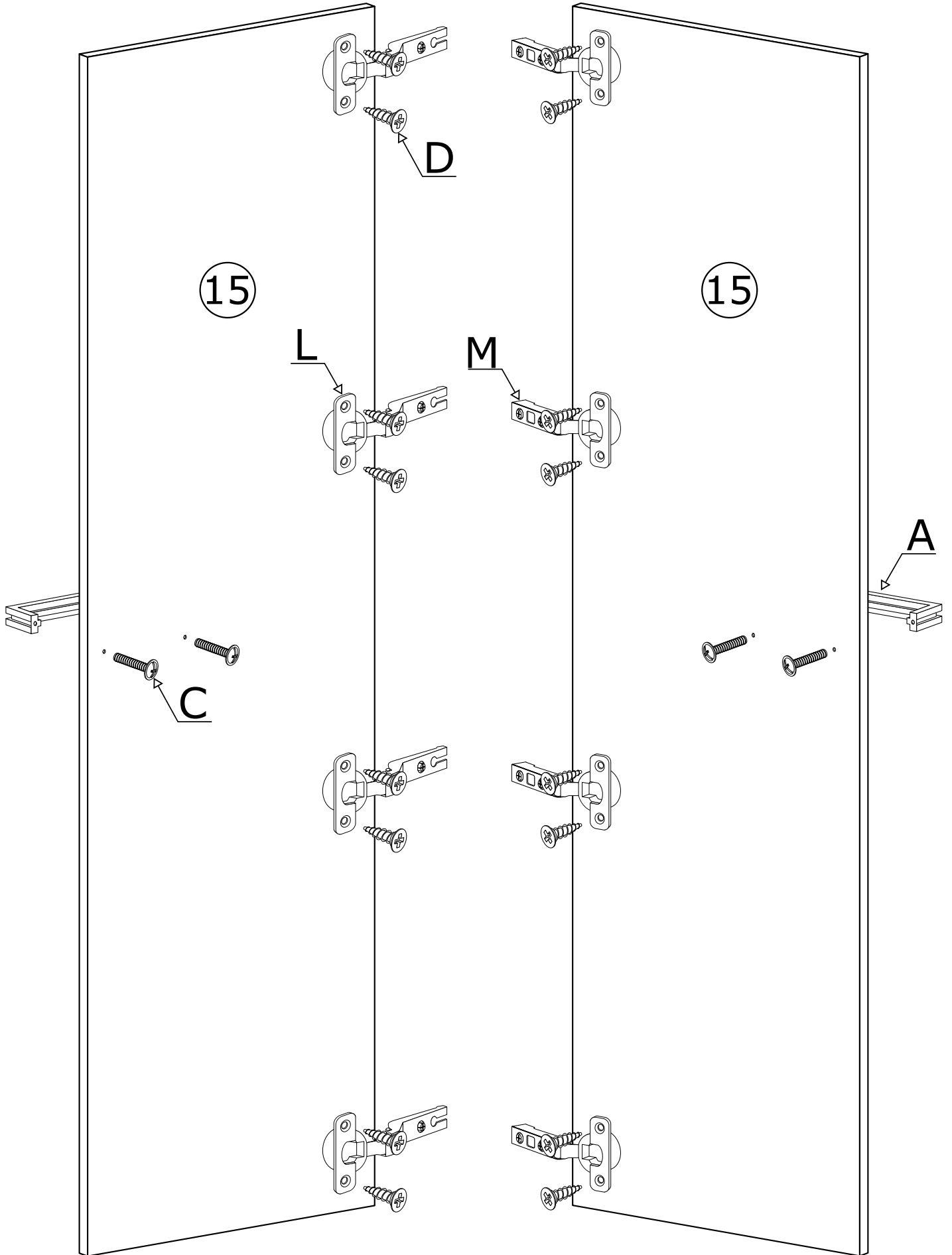

XI

