



www.MLMEBLE.pl

GB

D

CZ

SK

RUS

LT

assembly instructions / montageanleitung / montážní návod / montážny návod / инструкции по монтажу / surinkimo instrukcija



INSTRUKCJA MONTAŻU



PÓŁKA 01

↑ 29 → 120 ↗ 22

akcesoria / accessories / zubehör / příslušenství / příslušenstvo / аксессуары / furnitūra :



<p>x 8</p>  <p>KK 8/30</p>	<p>x 4</p>  <p>KT 6,3/60</p>	<p>x 4</p>  <p>ZAK</p>	<p>x 1</p>  <p>klej / glue / kleber / lepidlo / lepidlo / клей / kljaj</p>	<p>x 1</p>  <p>kluczyk / key / schlüssel / klíč / ključ / ключ / raktas</p>	<p>x 8</p>  <p>WT 3x16</p>	<p>x 2</p>  <p>ZA P90x37</p>
--	--	--	--	---	--	--

do montażu potrzebne są:

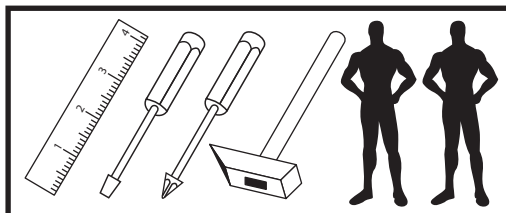
are needed for assembly:
sind erforderlich für die montage:
jsou potřebné pro montáž:
sú potrebné pre montáž:
которые необходимы для сборки:
Surinkimui reikės

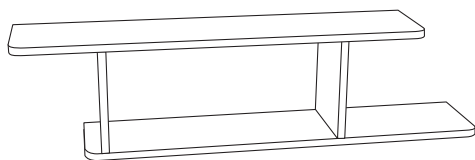



	CODE			
①	POLKA01_01	990	221	1
②	POLKA01_02	242	218	2
③	POLKA01_03	990	221	1
④				

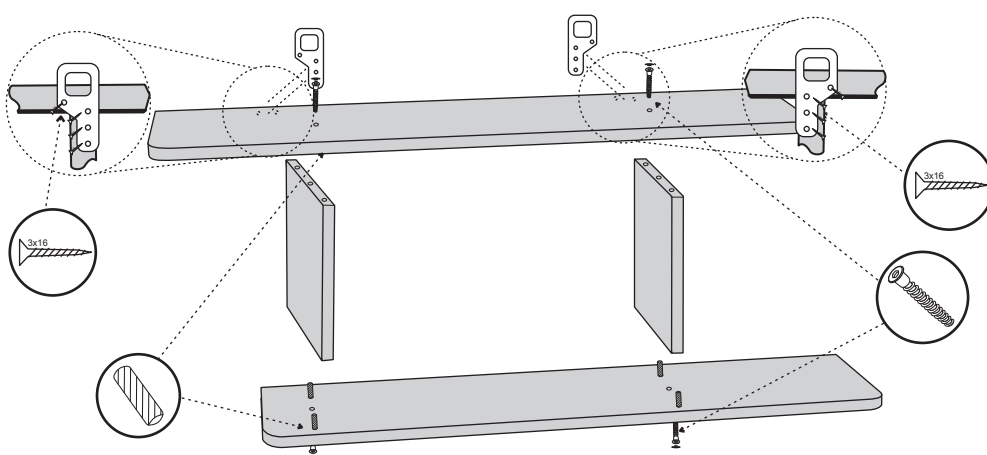
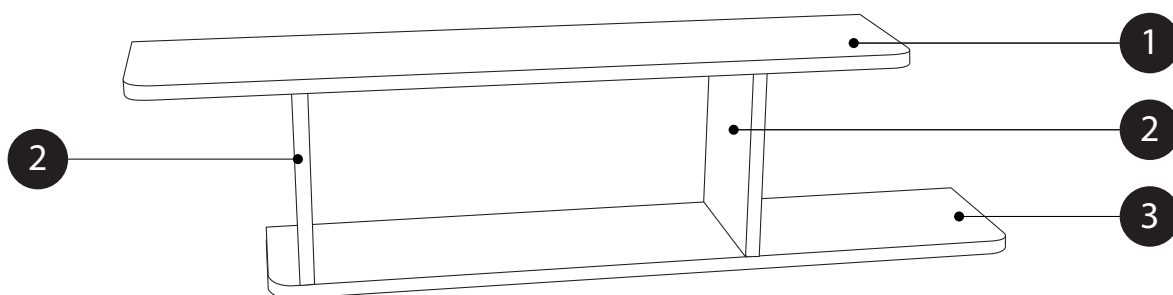

! **UWAGA!** - w pierwszej kolejności wbijamy akcesoria „KK” i „MD” w blaty oraz boki.
WARNING! - The first accessory sticks "KK" and "MD" in the tops and sides.
WARNUNG! - Die erste Accessoire-Sticks "KK" und "MD" in den Spitzen und an den Seiten.
POZOR! - První příslušenství holí "KK" a "MD" v korunách a boky.
POZOR! - Prvé príslušenstvo palíc "KK" a "MD" v korunách a boky.
ВНИМАНИЕ! - Первый аксессуаров палочки "KK" и "MD" по верхинам и по бокам.
DĖMESIO! - Pirmiausiai furnitūrą KK ir MD įkalame į stalviršį ir šonus.