



www.ML MEBLE .pl

GB

D

CZ

SK

RUS

LT

assembly instructions / montageanleitung / montážní návod / montážny návod / инструкции по монтажу / surinkimo instrukcija



INSTRUKCJA MONTAŻU

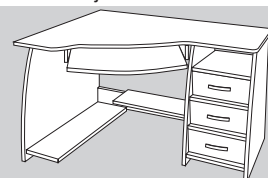

JOCKER L



↑ 75 → 124 ↗ 88

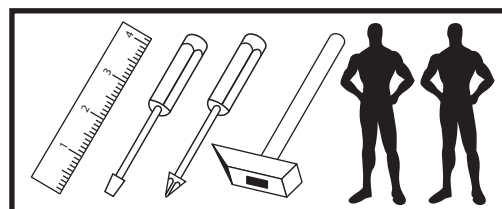

akcesoria / accessories / zubehör / příslušenství / prislušenstvo / аксессуары / furnitūra :

<p>x 36</p> <p>KK 8/32</p>	<p>x 30</p> <p>KT 6,3/50</p>	<p>x 16</p> <p>MD</p>	<p>x 1</p> <p>klej / glue / kleber / lepidlo / lepidlo / клей / kljaj</p>	<p>x 40</p> <p>GZ 1,4x25</p>	<p>x 1</p> <p>kluczyk / key / schlüssel / klíč / kľúč / ключ / raktas</p>	<p>x 48</p> <p>WT 3,5x16</p>	<p>x 6</p> <p>WT 4x35</p>
<p>x 22</p> <p>ZAK</p>	<p>x 3</p> <p>UT L96</p>	<p>x 4</p> <p>PA L350</p>	<p>x 6</p> <p>SG 8/8</p>				

do montażu potrzebne są:
are needed for assembly:
sind erforderlich für die montage:
jsou potřebné pro montáž:
sú potrebné pre montáž:
которые необходимы для сборки:
Surinkimui reikės



	CODE			
1	JOCKERL_01	1233	880	1
2	JOCKERL_02	720	500	1
3	JOCKERL_04	720	500	1
4	JOCKERL_03	720	790	1
5	JOCKERL_05	720	220	1
6	JOCKERL_06	400	100	1
7	JOCKERL_07	400	100	1
8	JOCKERL_08	610	395	1
9	JOCKERL_09	820	124	1
10	JOCKERL_10	325	144	3
11	JOCKERL_11	350	112	6
12	JOCKERL_12	269	112	3
13	JOCKERL_13	635	60	1
14	JOCKERL_14	330	92	4
15	JOCKERL_15	330	412	1

	CODE			
16	JOCKERL_16	570	272	1
17	JOCKERHDF_01	670	360	1
18	JOCKERHDF_02	355	298	3
19				

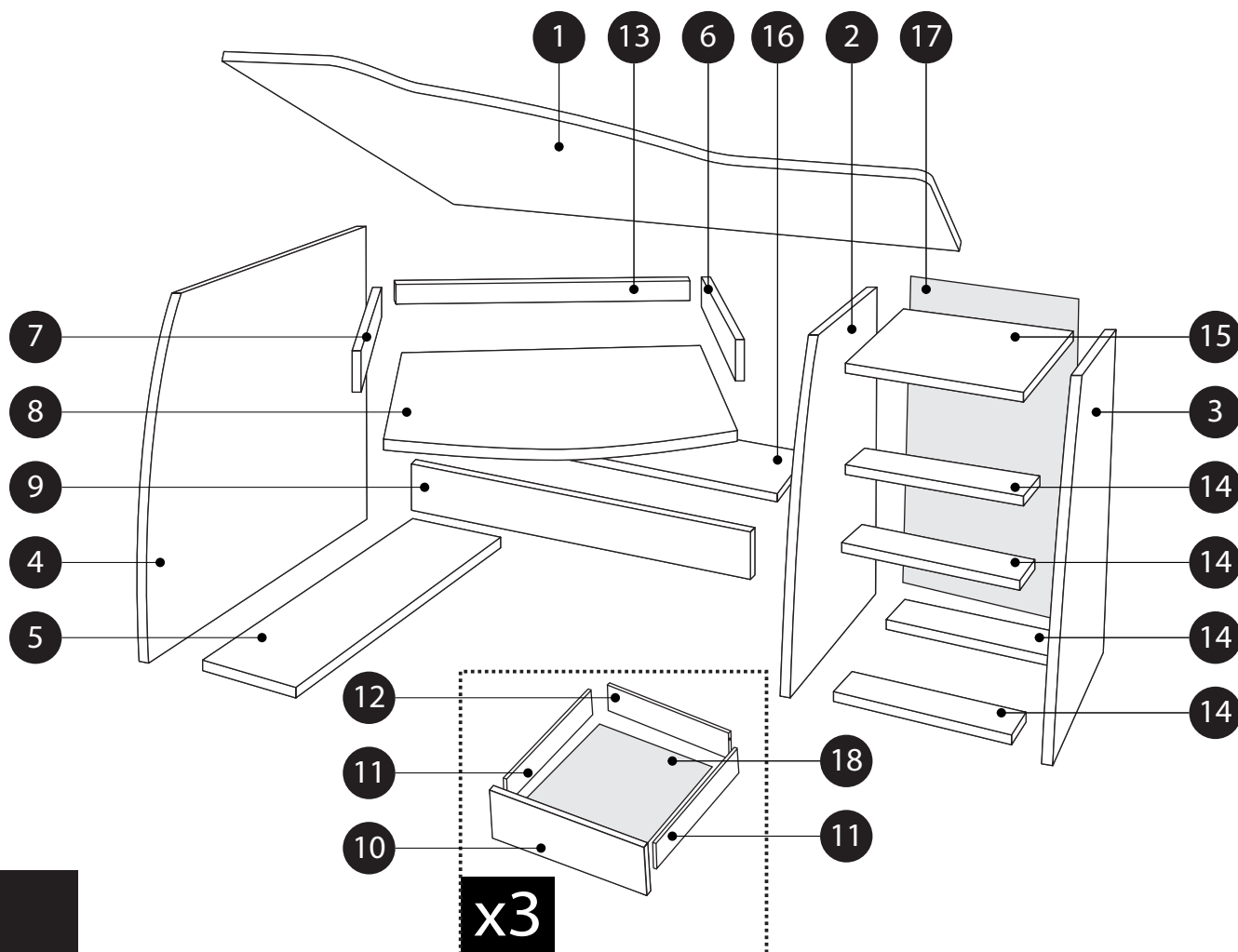
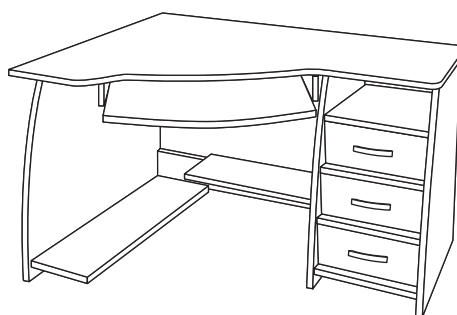

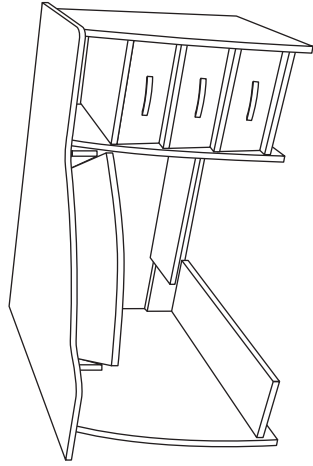

! UWAGA! - w pierwszej kolejności wbijamy akcesoria „KK” i „MD” w boki blaty.
WARNING! - The first accessory sticks “KK” and “MD” in the tops and sides.
POZOR! - První příslušenství holi “KK” a “MD” v korunách a boky.
ПОЗОРИ! - Прве прислушество палици “KK” и “MD” по верхинам и по бокам.
DÉMESIO! - Pirmiausiai pritvirtinti KK ir MD įkalame į stalviršį ir šonus.

I W pierwszej kolejności przykręć prowadnice.

First, tighten the guides.
 Zuerst ziehen Sie die Führer.
 Po prvé, utiahnite sprievodcov.
 Во-первых, укроточить гидов.
 Pirmiausiai prisukite bėgelius.

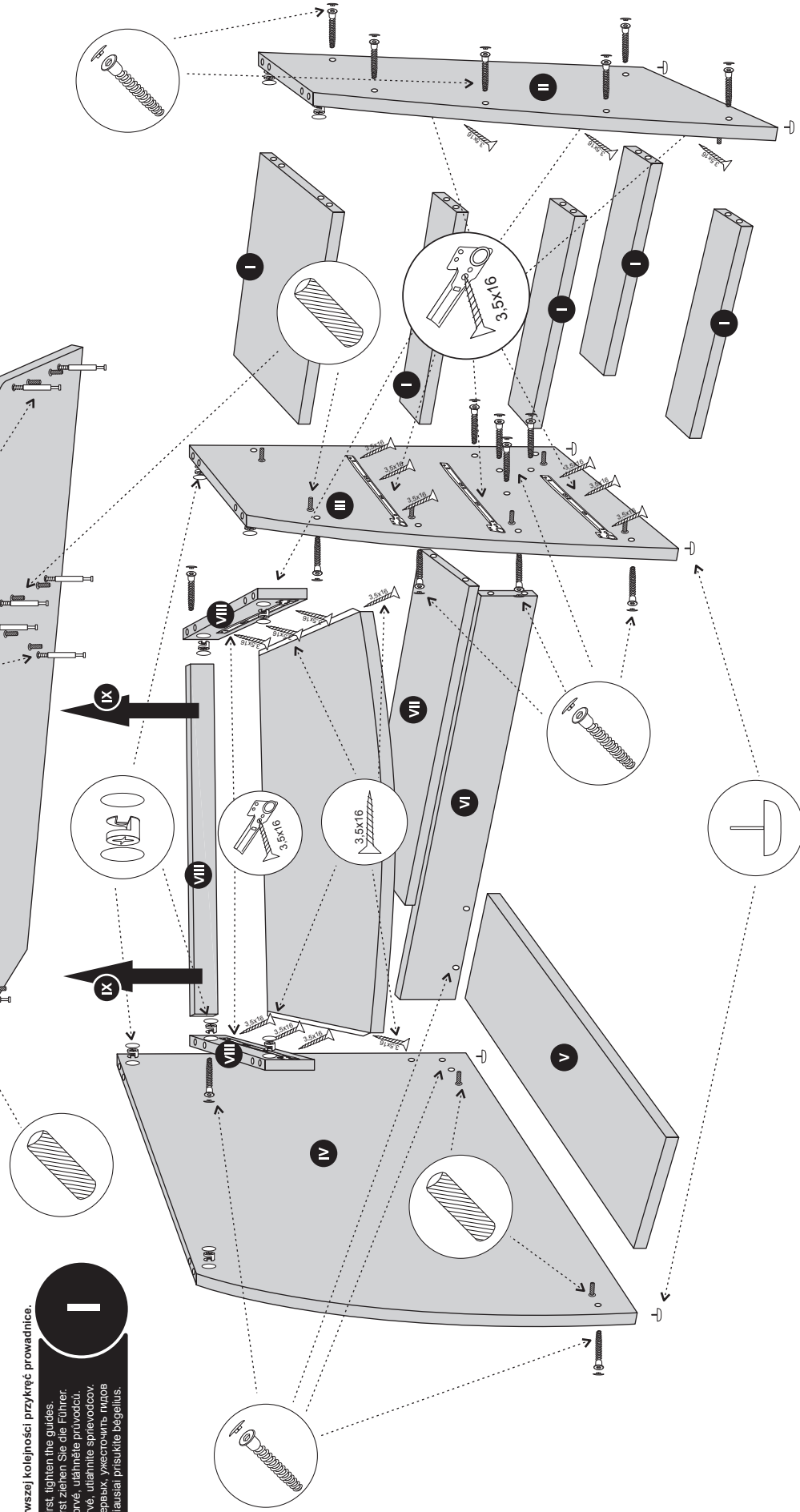

Kolejność montażu: **I** **II** **III**

