

LIVINIO 1

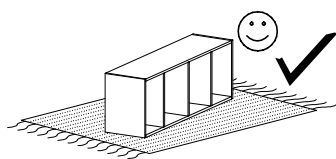

Narzędzia potrzebne do montażu

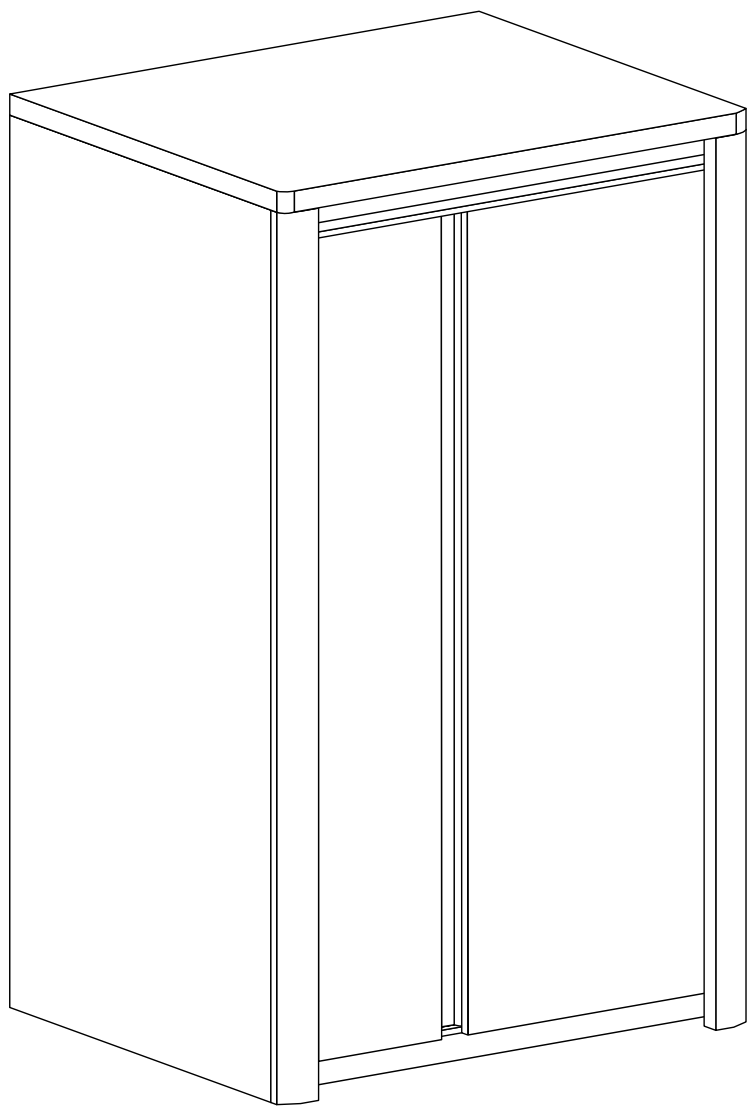
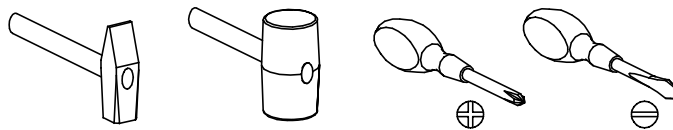

Nr	Nazwa elementu	D[mm]	S[mm]	G[mm]	Ilość
1	Bok P/L	1916	557	16	2
2	Błat Górny	981	587	48	1
3	Przegroda	1750	528	16	1
4	Wieniec G/D	946	557	16	2
5	Cokół	946	80	16	2
6	Listwa Górna	946	54	16	1
7	Listwa MDF P/L	1916	80	28	2
8	Listwa MDF	1750	70	28	1
9	Półka	500	312	16	3
10	Kapak	1880	332	2,5	1
11	Kapak	1880	319	2,5	2
12	Drzwi	1795	515	16	1
13	Drzwi Małe	1795	266	16	1

UWAGA !!!

MONTOWANIE USZKODZONYCH
ELEMENTÓW POWODUJE UTRATĘ
GWARANCJI

W przypadku reklamacji proszę podać numer pakowacza znajdujący się na kartonie.

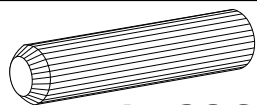

A - 36 St.

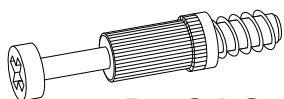

B - 24 St.

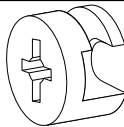

C - 24 St.

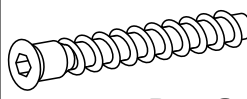

D - 6 St.

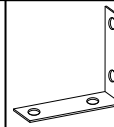

Y1 - 1 St.

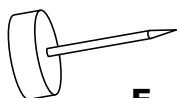

E - 8 St.

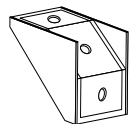

F - 5 St.

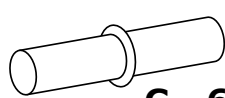

G - 6 St.



H - 2 St.

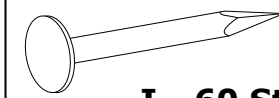

I - 60 St.

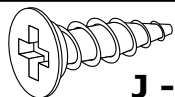

J - 42 St.
3,5x16 mm

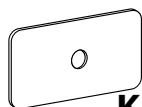

K - 12 St.

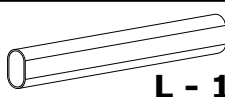

L - 1 St.
608 mm

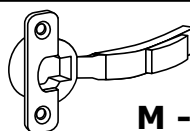

M - 8 St.

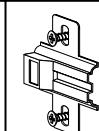

N - 8 St.



X1 - 24 St.

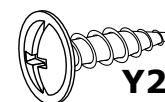

Y2 - 2 St.
3,5x16 mm

I

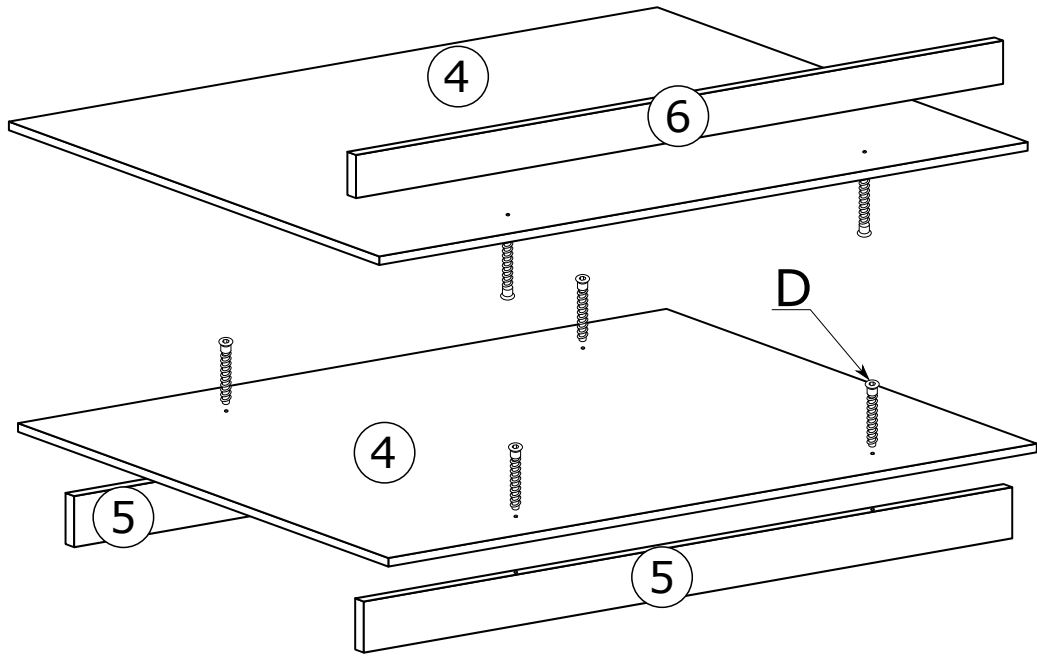

II

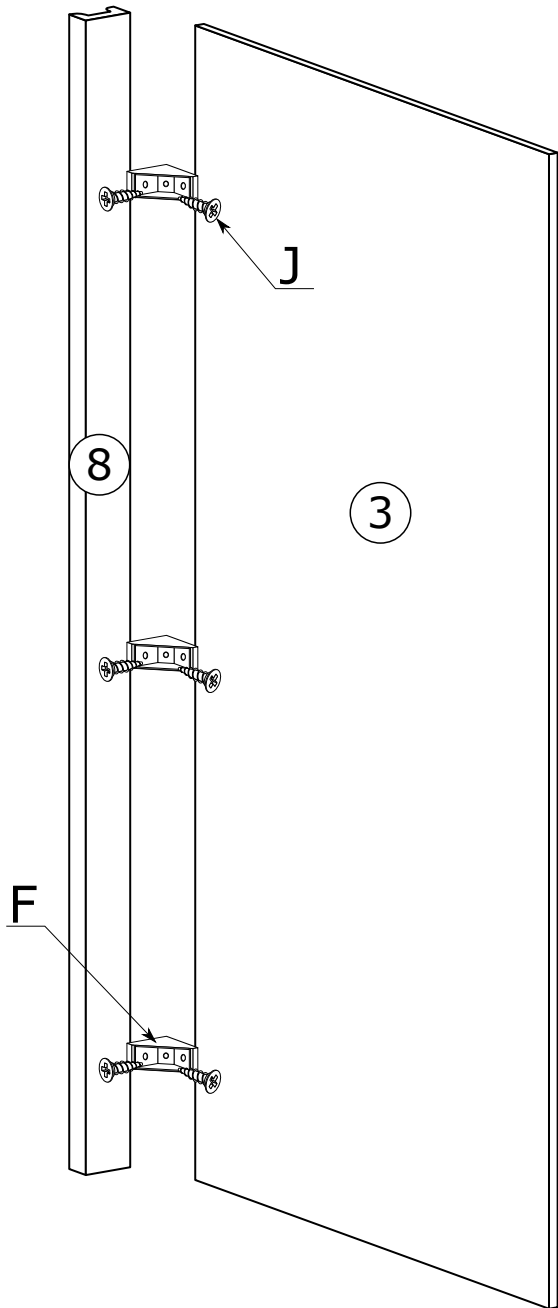

III

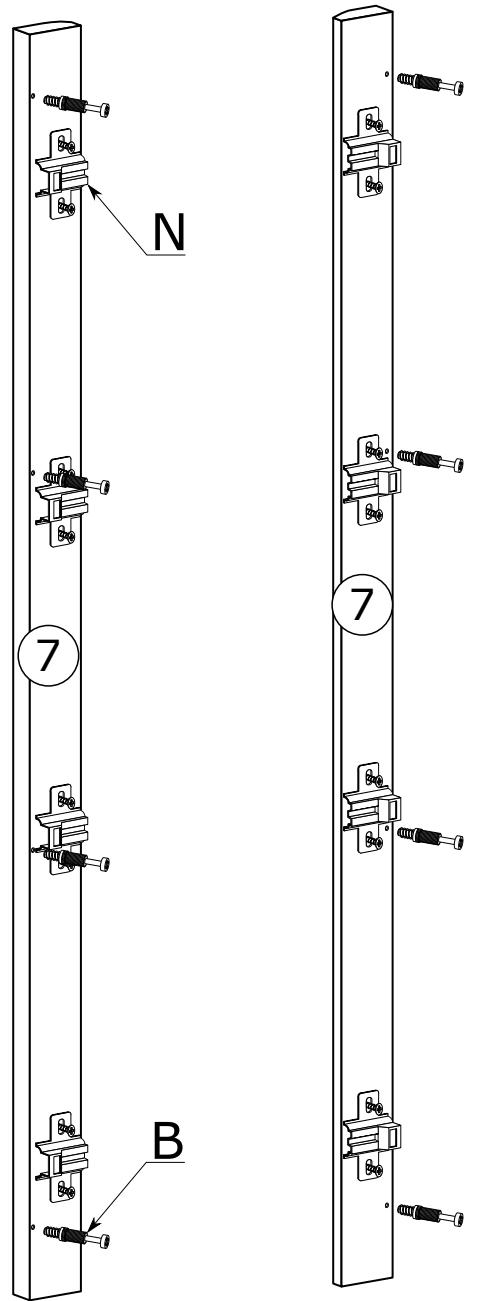

IV

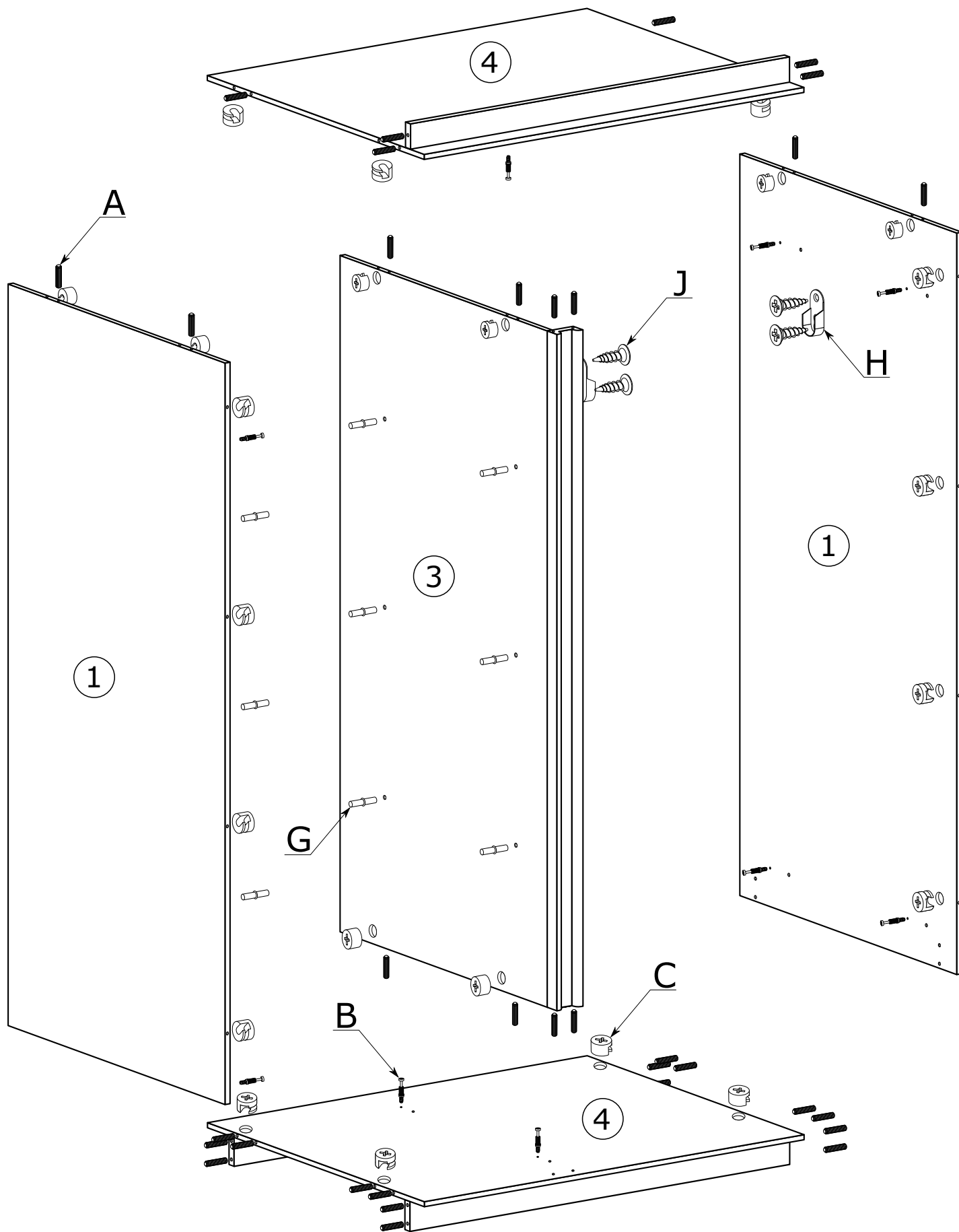

V

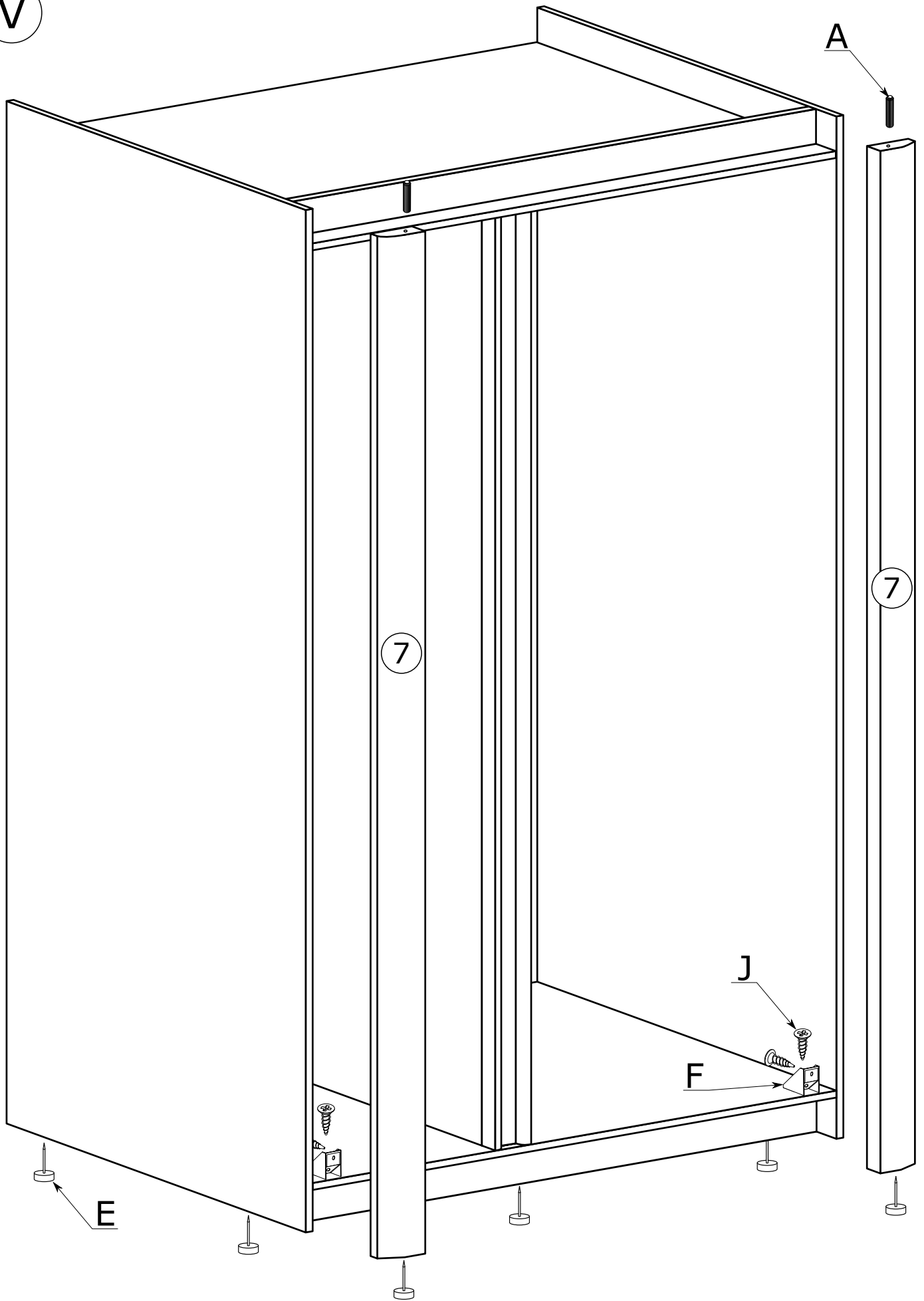

VI

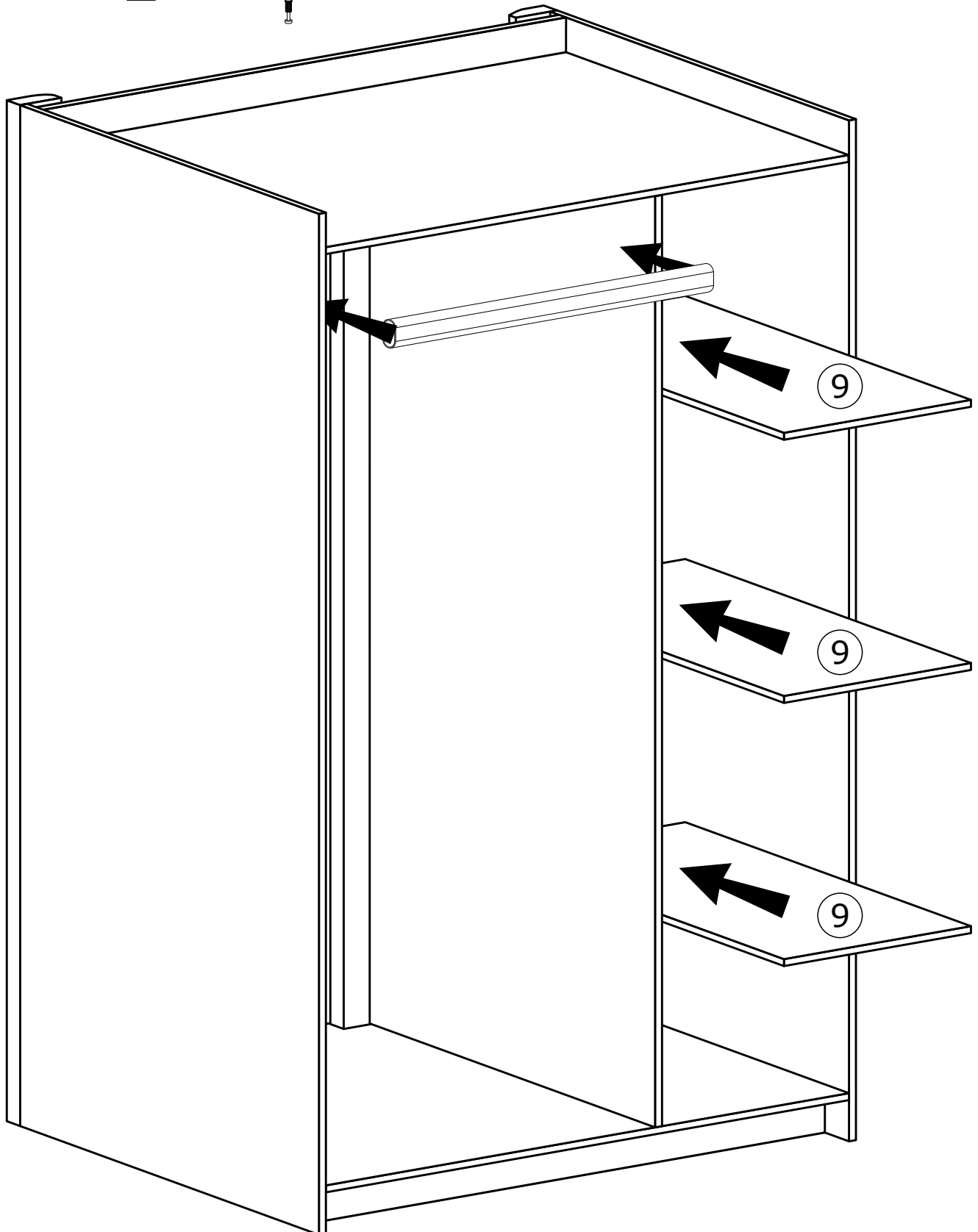
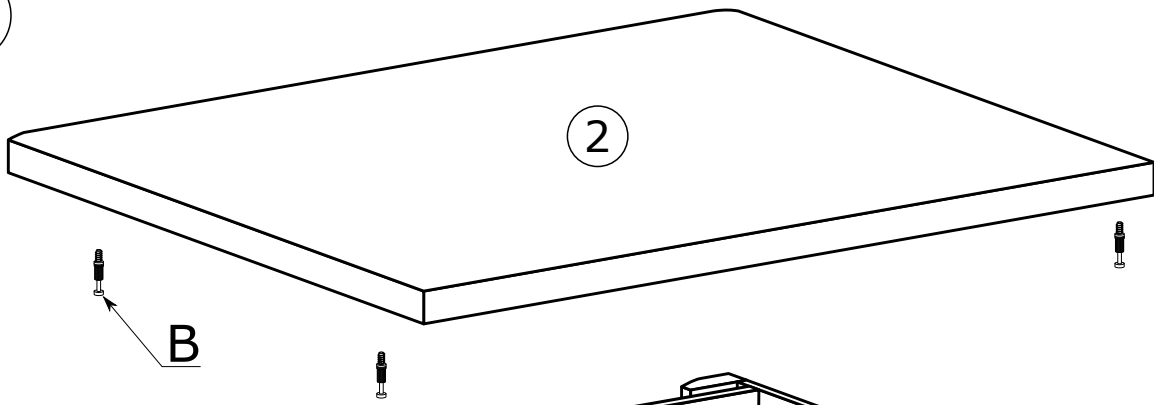

VII

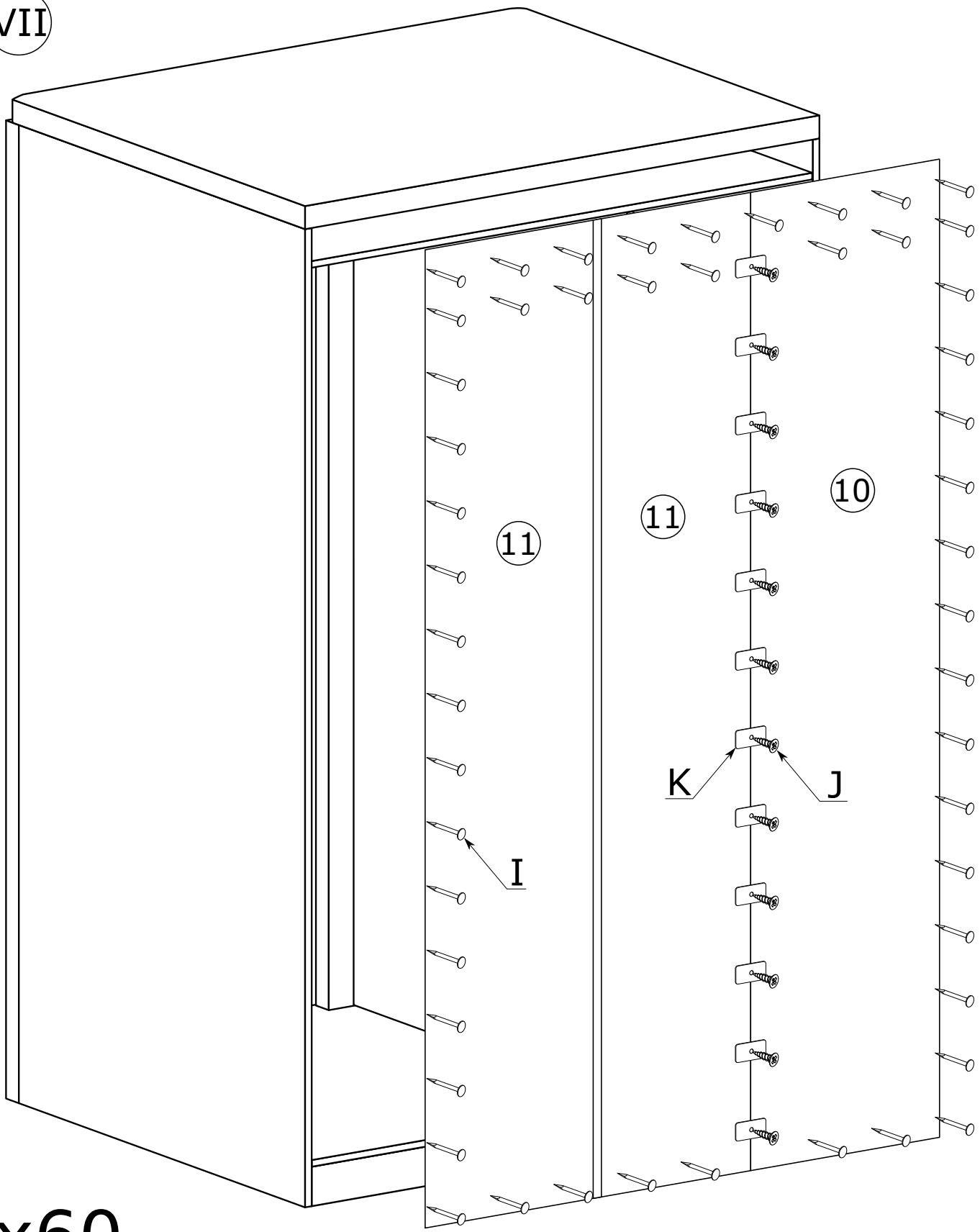

x60

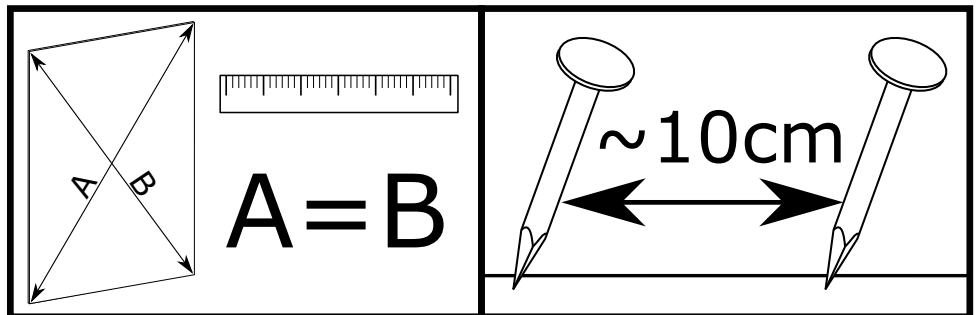

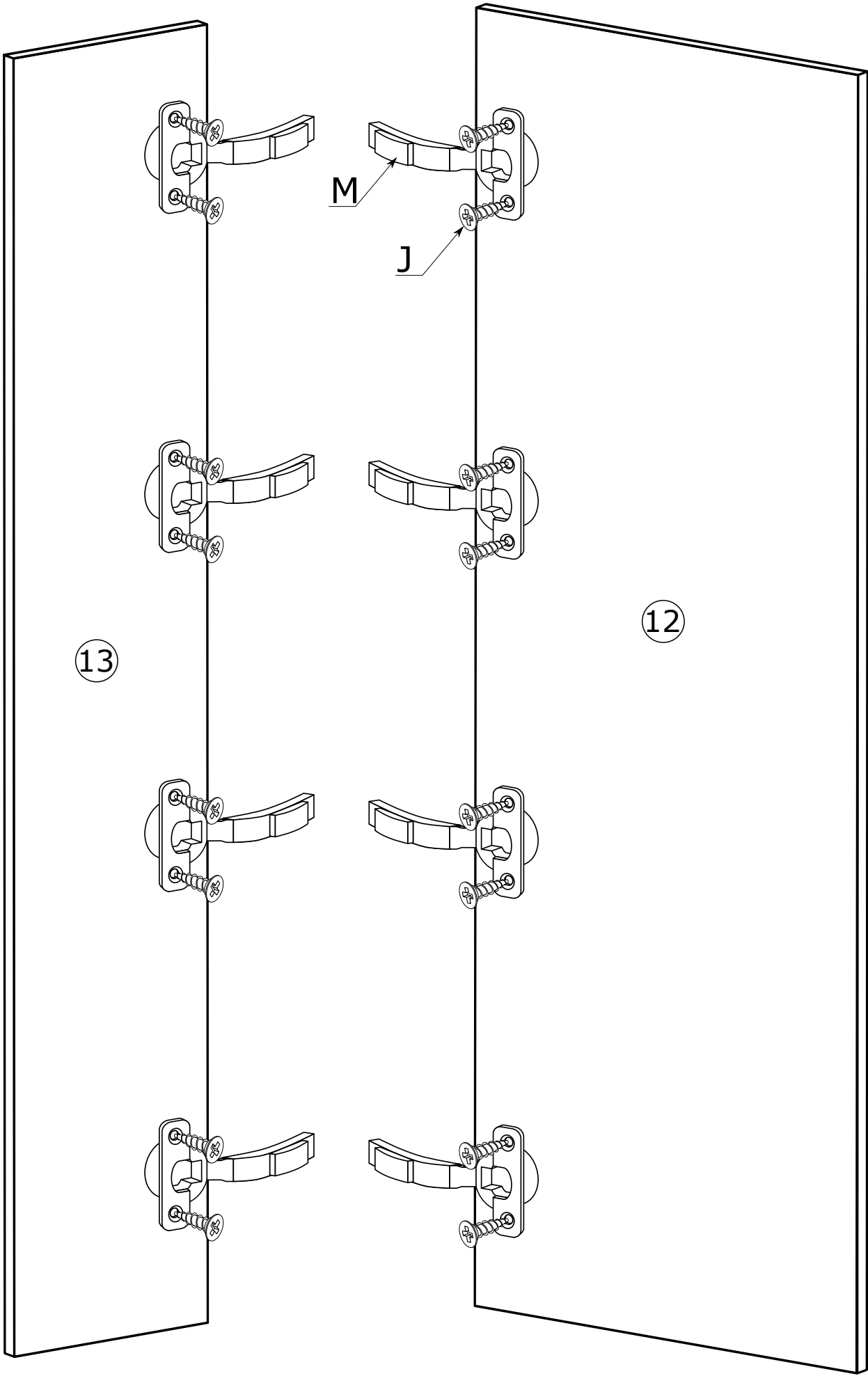

13

12

IX

