

PARIS

P-1

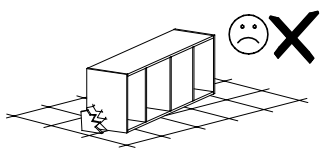

Narzędzia potrzebne do montażu

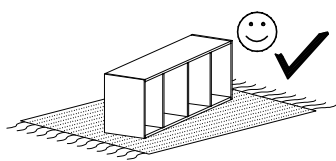
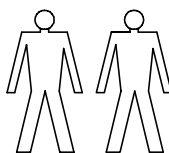
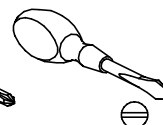
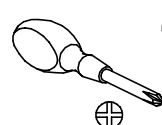
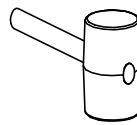
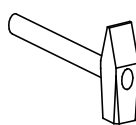

UWAGA !!

MONTOWANIE USZKODZONYCH
ELEMENTÓW POWODUJE UTRATĘ
GWARANCJI

nr	D[mm]	S[mm]	G[mm]	Ilość
1	882	602	48	1
2	882	602	48	1
3	848	553	16	1
4	1790	600	48	1
5	1790	600	48	1
6	1840	436	2,5	2
7	1783	388	16	1
8	1783	388	16	1

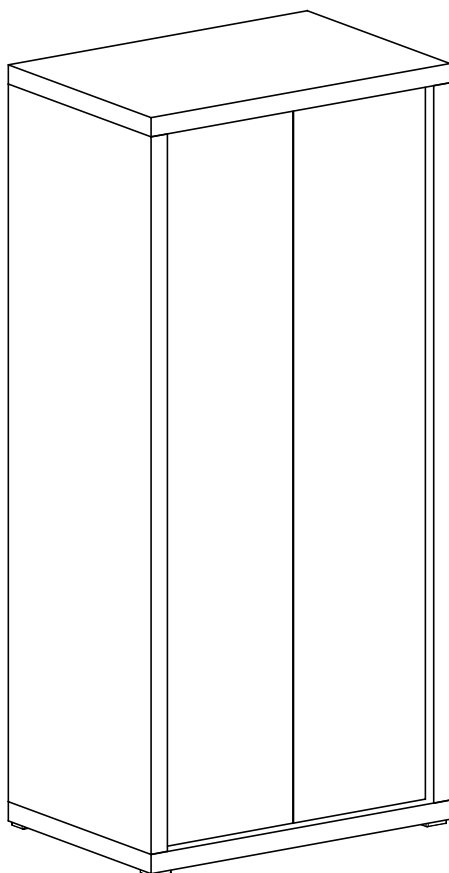

W przypadku reklamacji proszę o podanie numeru pakowacza znajdującego się na kartonie

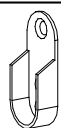

Y - 2 St.



R - 1 St.
840mm

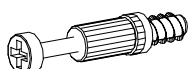

K - 16 St.



G - 24 St.
3,5 x 16 mm



E - 80 St.

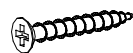

M - 8 St.
3 x 25 mm

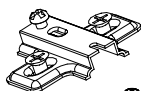

C - 8 St.

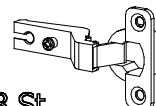

D - 8 St.

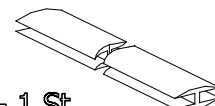

H - 1 St.

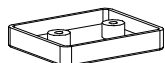

A - 4 St.



B - 16 St.



L - 16 St.



Z - 1 St.

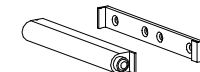

F - 2 St.

I

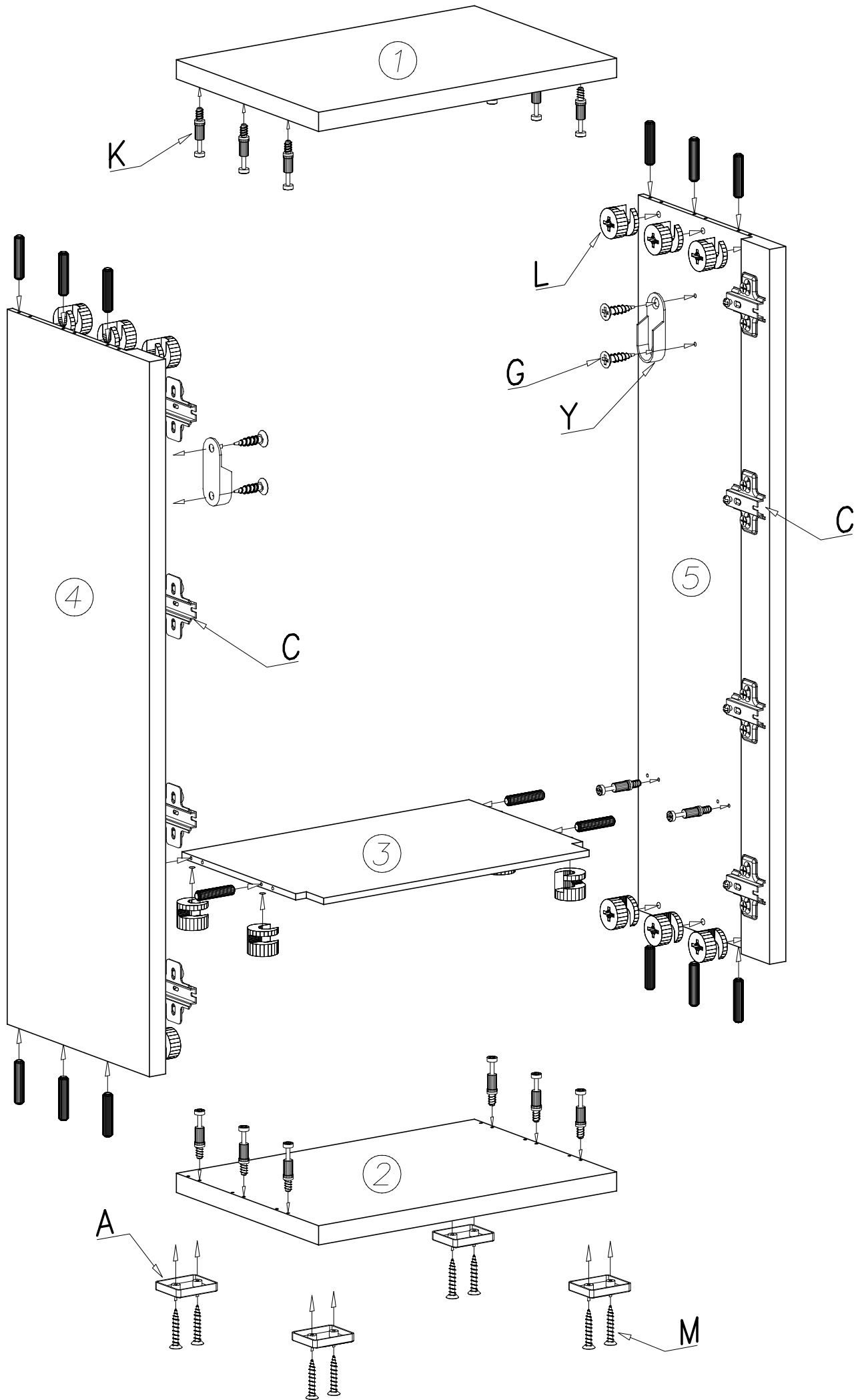

II

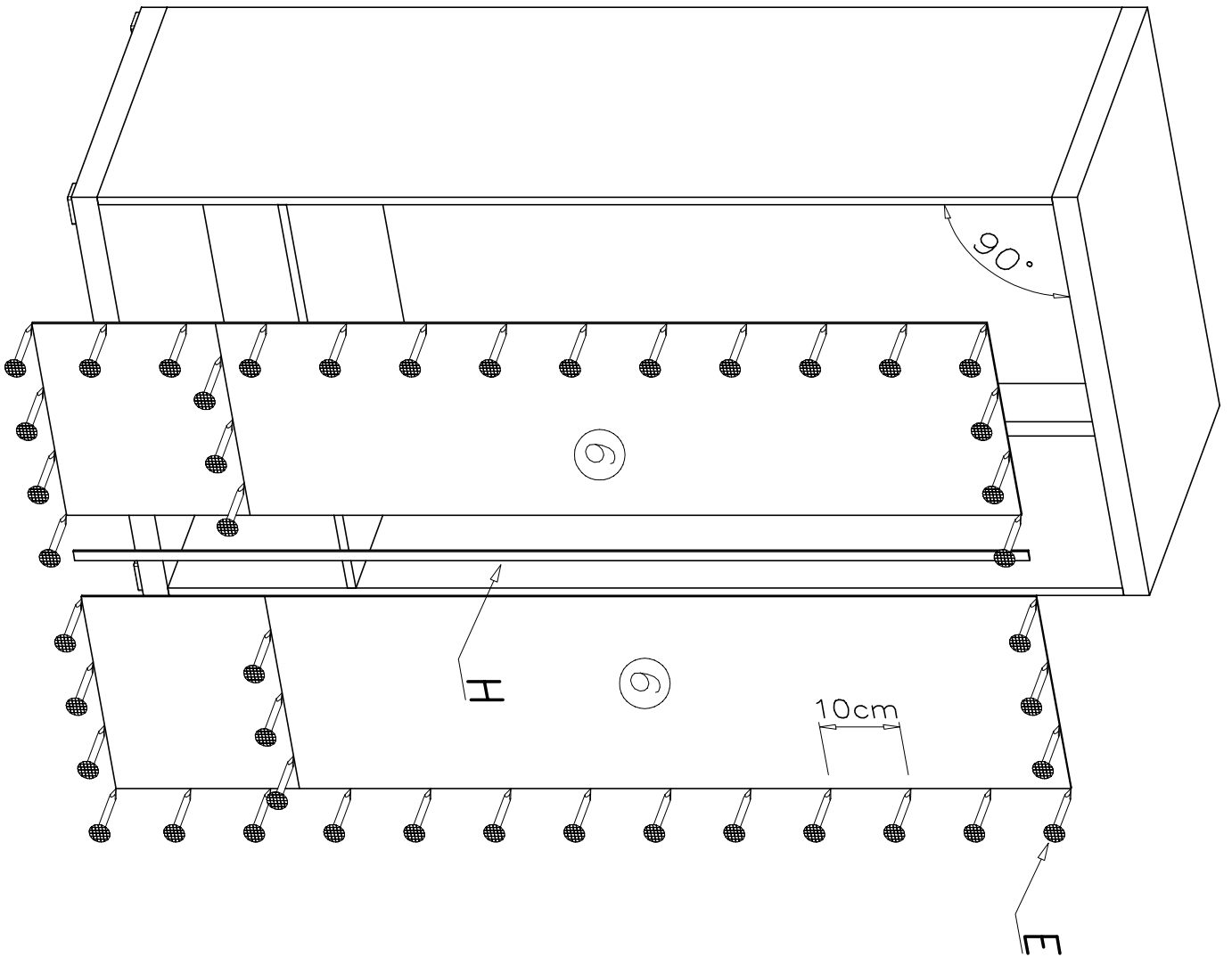

III

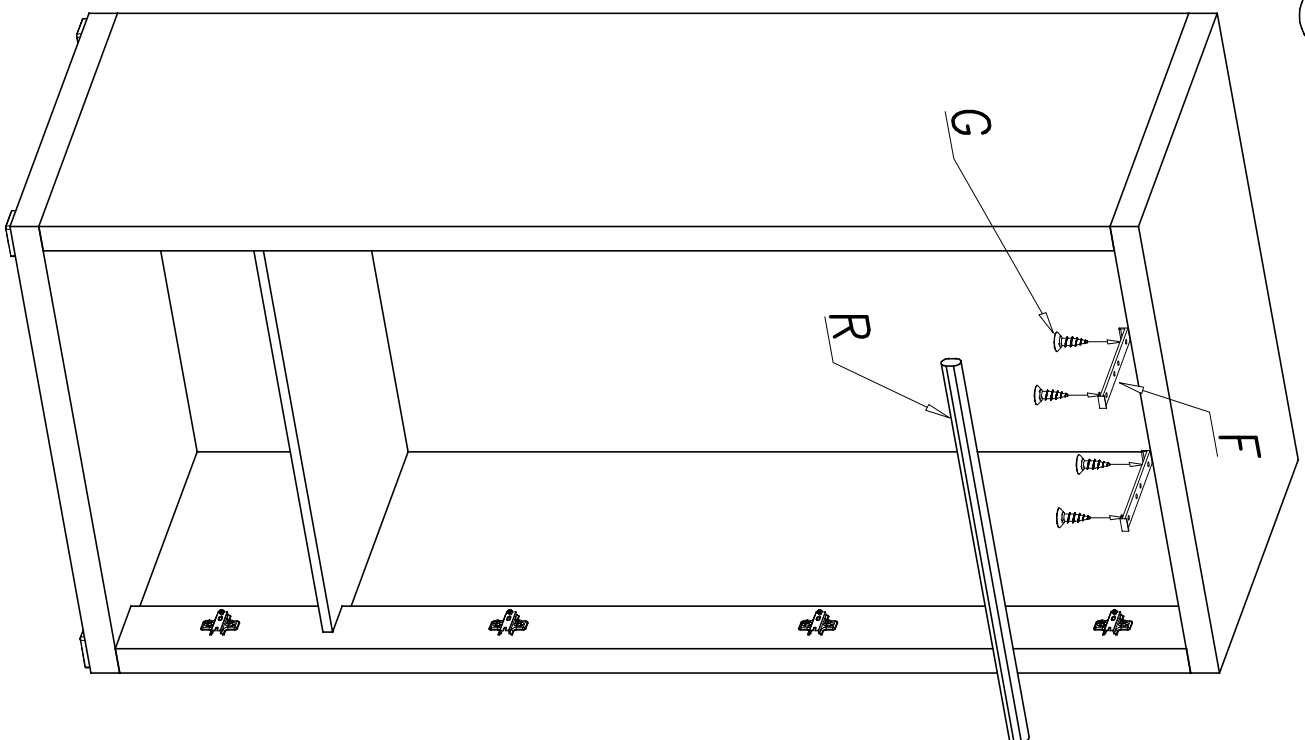

IV

