

# NATURAL 18

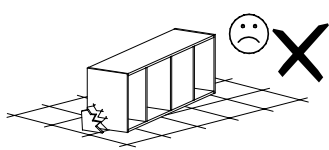

Narzędzia potrzebne do montażu

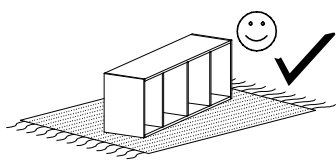
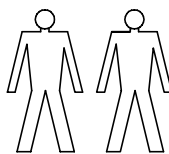
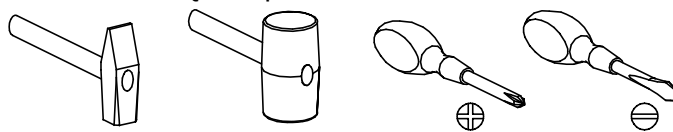

## UWAGA !!!

MONTOWANIE USZKODZONYCH  
ELEMENTÓW POWODUJE UTRATĘ  
GWARANCJI

# A

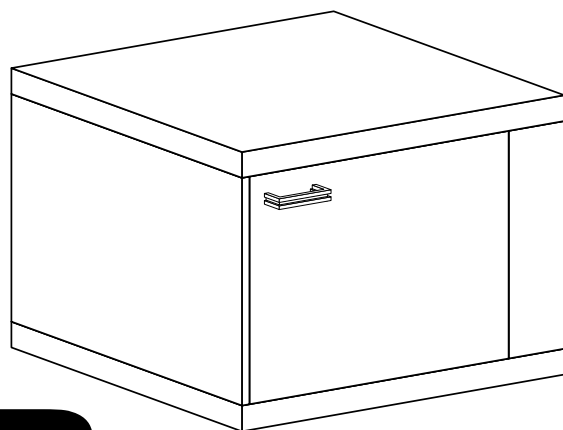

# B

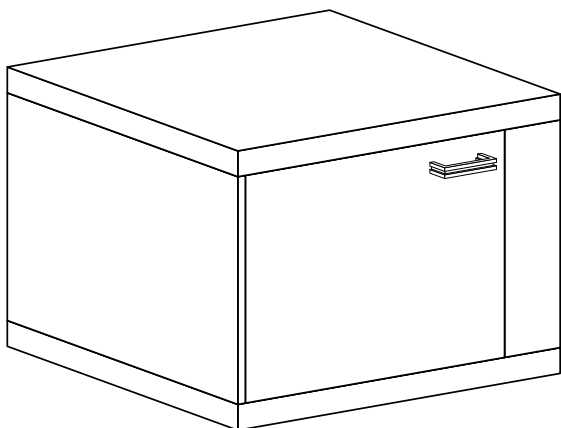

Nr	D[mm]	S[mm]	G[mm]	Ilość
1	405	400	16	1
2	400	389	16	1
3	568	405	48	1
4	568	405	48	1
5	400	100	16	1
6	533	389	16	1
7	560	227	2,5	2
8	445	394	16	1

## UWAGA !!!

Mebel zawiera  
elementy drewniane

W przypadku reklamacji proszę podać numer pakowacza znajdujący się na kartonie.

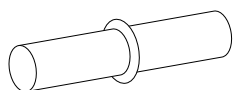

**B - 4 St.**



**A - 1 St.**

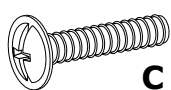

**C - 2 St.**  
4x25 mm

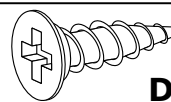

**D - 4 St.**  
3,5x16 mm

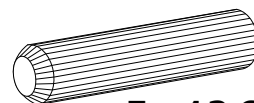

**E - 12 St.**

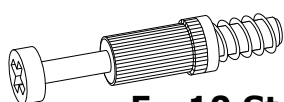

**F - 10 St.**

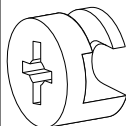

**G - 10 St.**

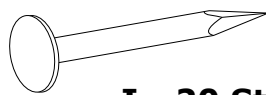

**I - 20 St.**

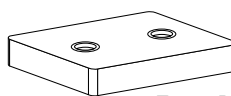

**J - 4 St.**

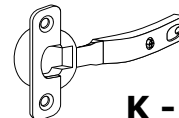

**K - 2 St.**

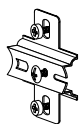

**L - 2 St.**

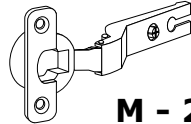

**M - 2 St.**

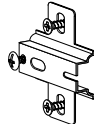

**N - 2 St.**

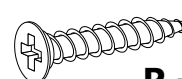

**P - 8 St.**  
3,5x25 mm

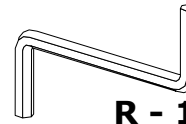

**R - 16 St.**

I

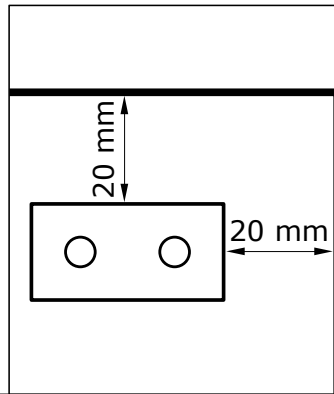
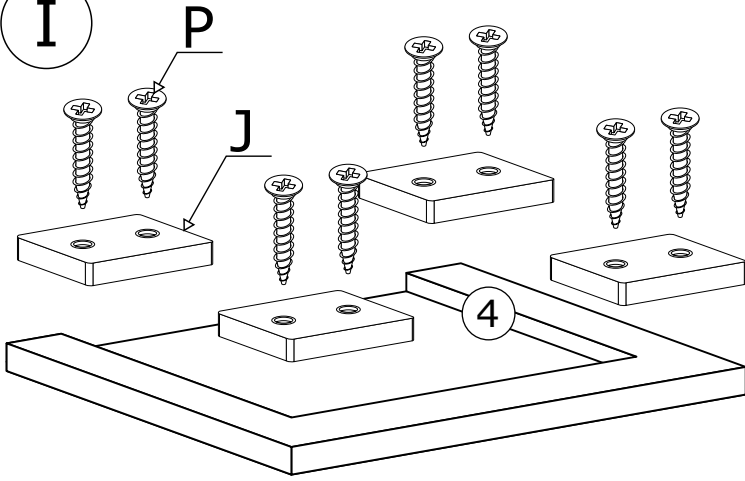

II

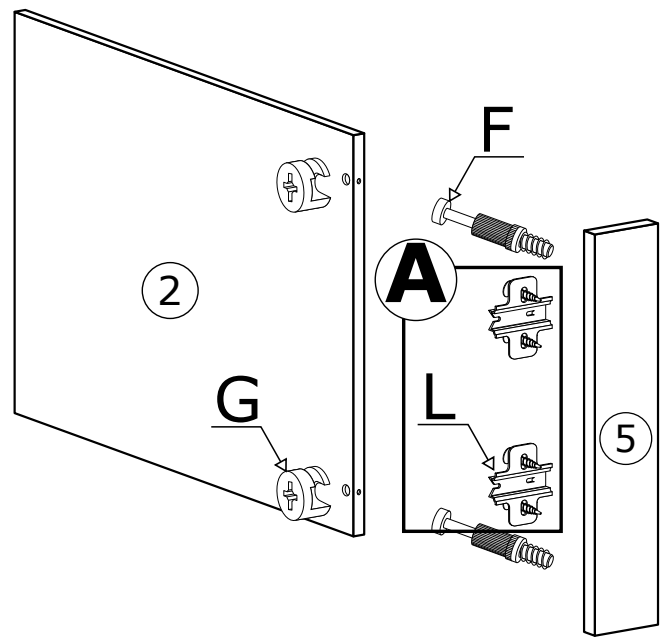

III

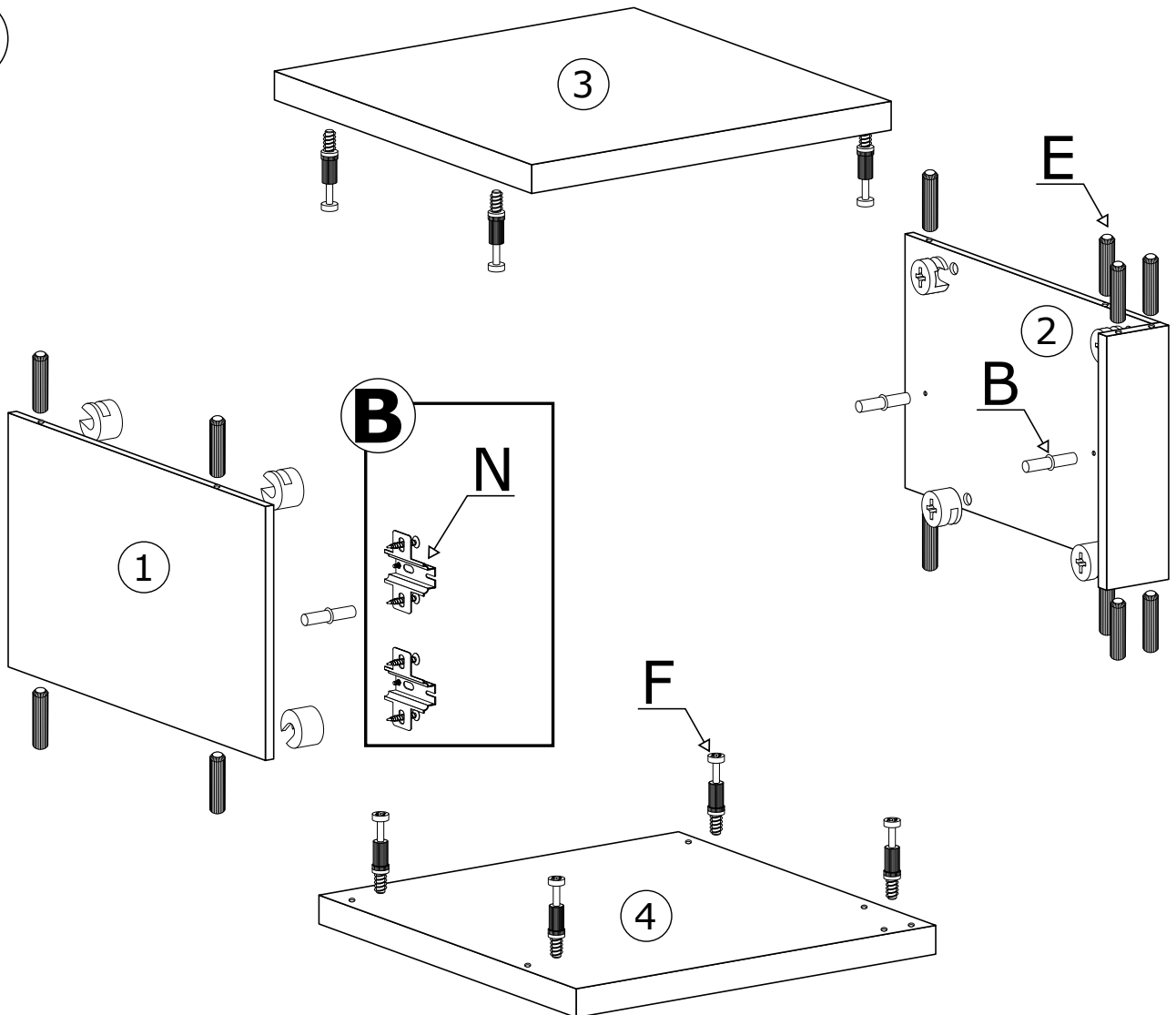

IV

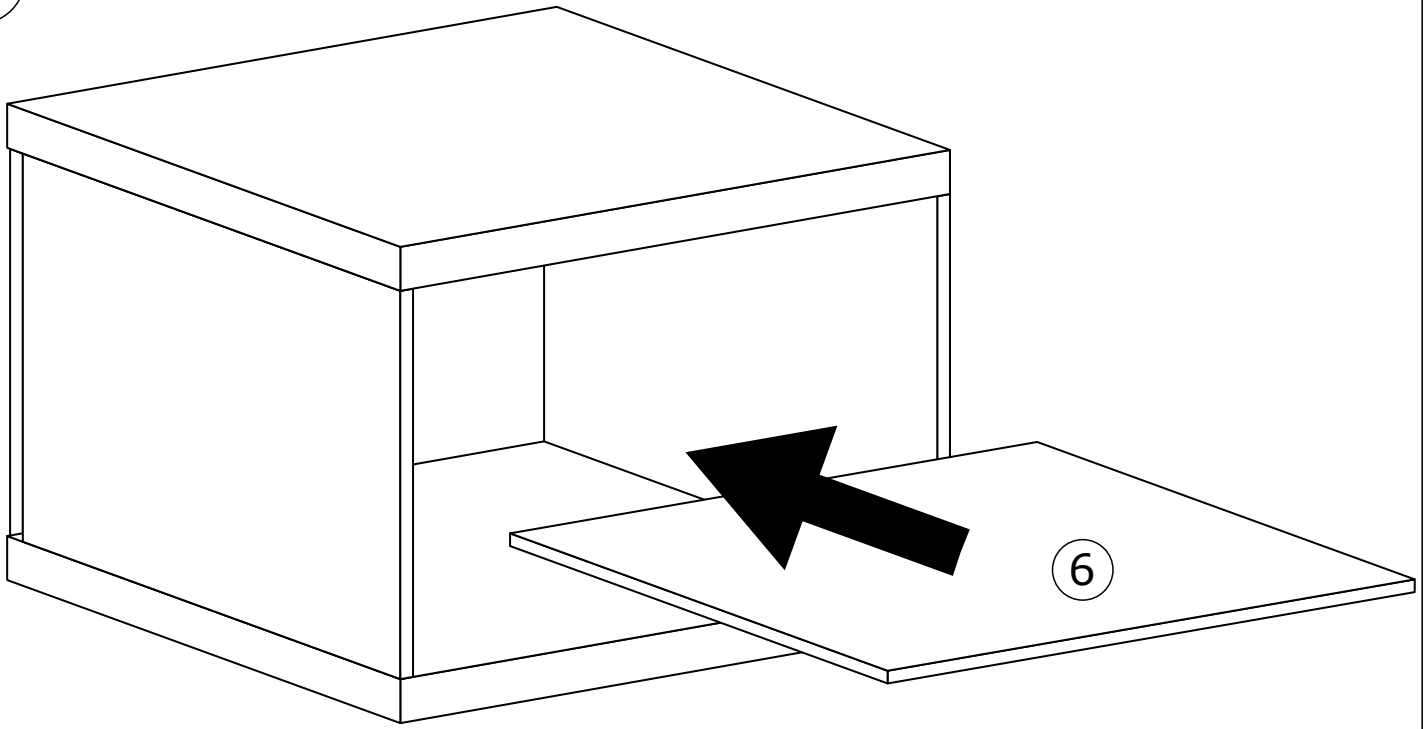

V

 x20

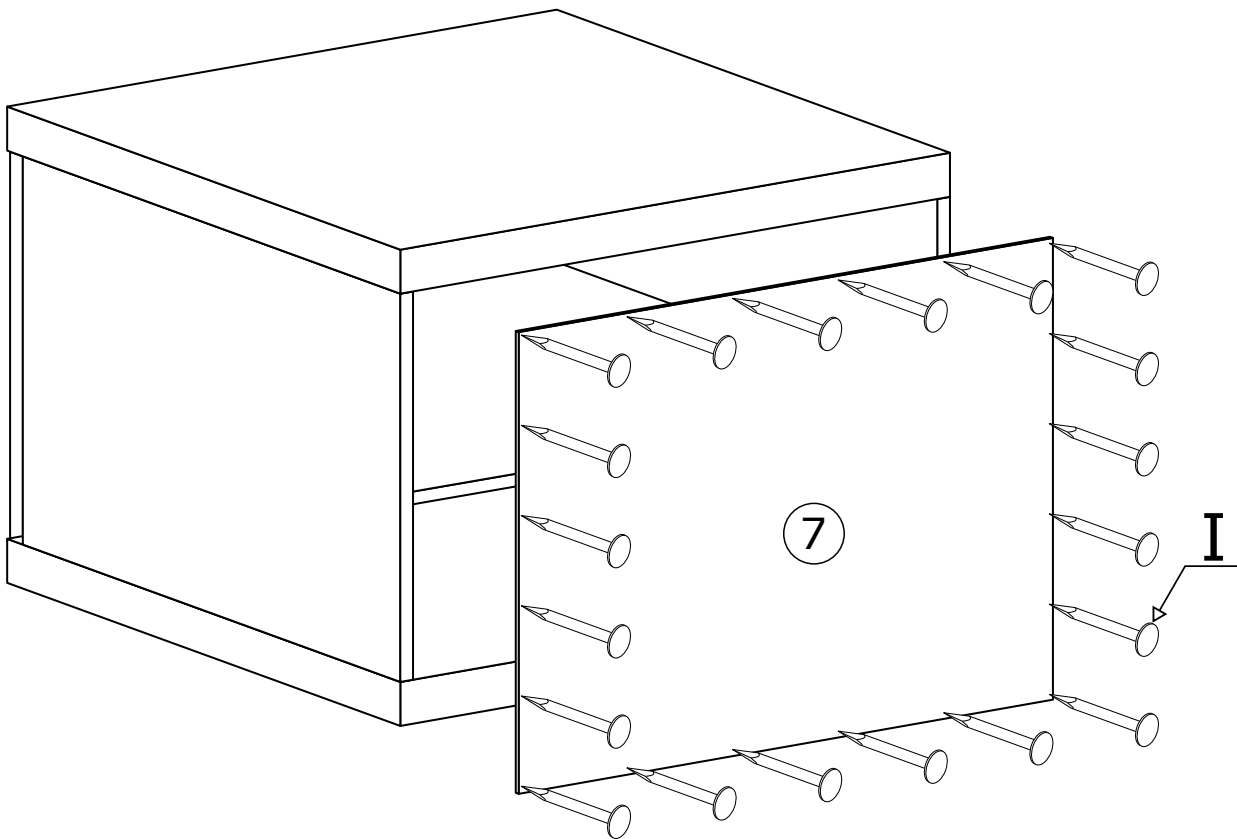

V

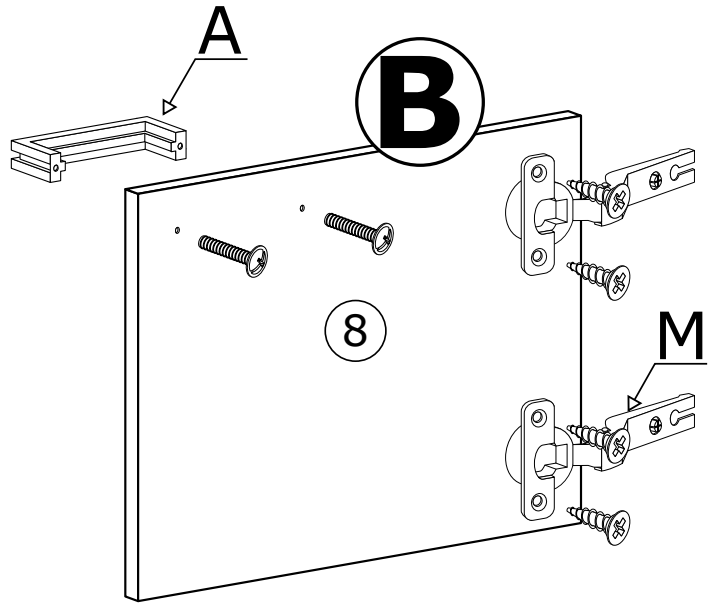
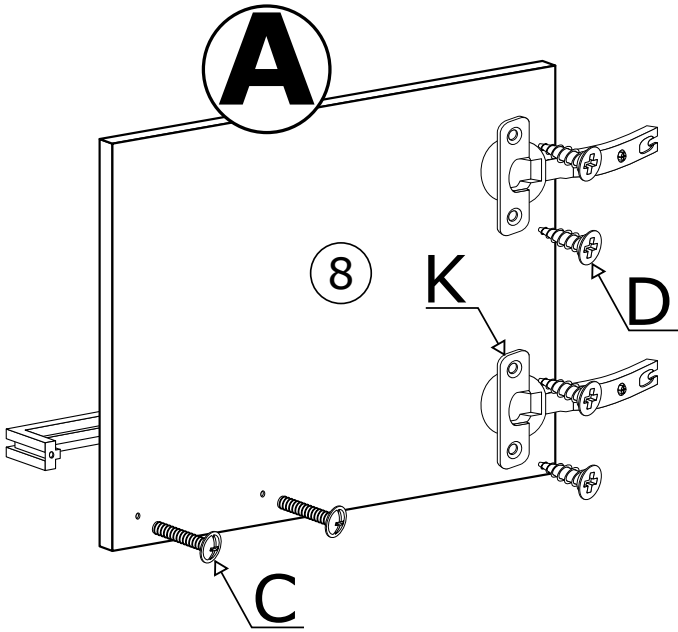

VI

