

NATURAL 1



Narzędzia potrzebne do montażu



UWAGA !!!

MONTOWANIE USZKODZONYCH
ELEMENTÓW POWODUJE UTRATĘ
GWARANCJI

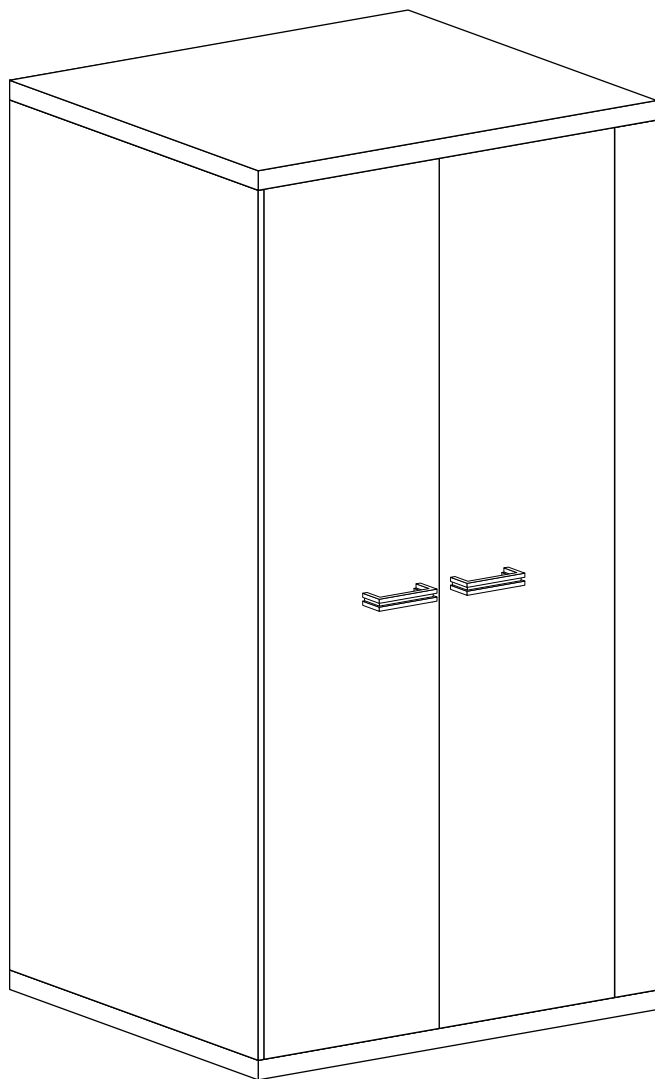

| Nr | D[mm] | S[mm] | G[mm] | Ilość |
|----|-------|-------|-------|-------|
| 1 | 1900 | 576 | 16 | 1 |
| 2 | 1900 | 560 | 16 | 1 |
| 3 | 1018 | 577 | 48 | 1 |
| 4 | 1018 | 577 | 48 | 1 |
| 5 | 983 | 560 | 16 | 1 |
| 6 | 983 | 120 | 16 | 1 |
| 7 | 1900 | 100 | 16 | 1 |
| 8 | 1950 | 1100 | 2,5 | 1 |
| 9 | 1894 | 445 | 16 | 2 |

UWAGA !!!

Mebel zawiera
elementy drewniane



R - 1 St.

W przypadku reklamacji proszę podać numer pakowacza znajdujący się na kartonie.

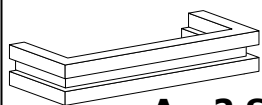

A - 2 St.

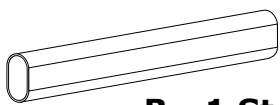

B - 1 St.

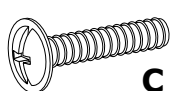

C - 4 St.
4x25 mm

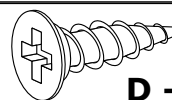

D - 28 St.
3,5x16 mm

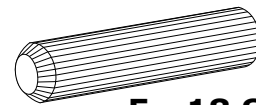

E - 18 St.

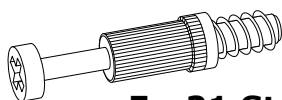

F - 21 St.

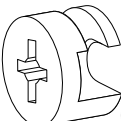

G - 21 St.

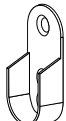

H - 2 St.



I - 80 St.

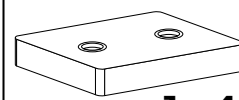

J - 4 St.

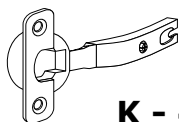

K - 4 St.

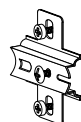

L - 4 St.

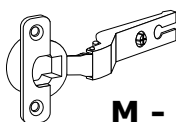

M - 4 St.

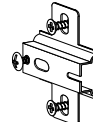

N - 4 St.

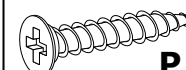

P - 8 St.
3,5x25 mm

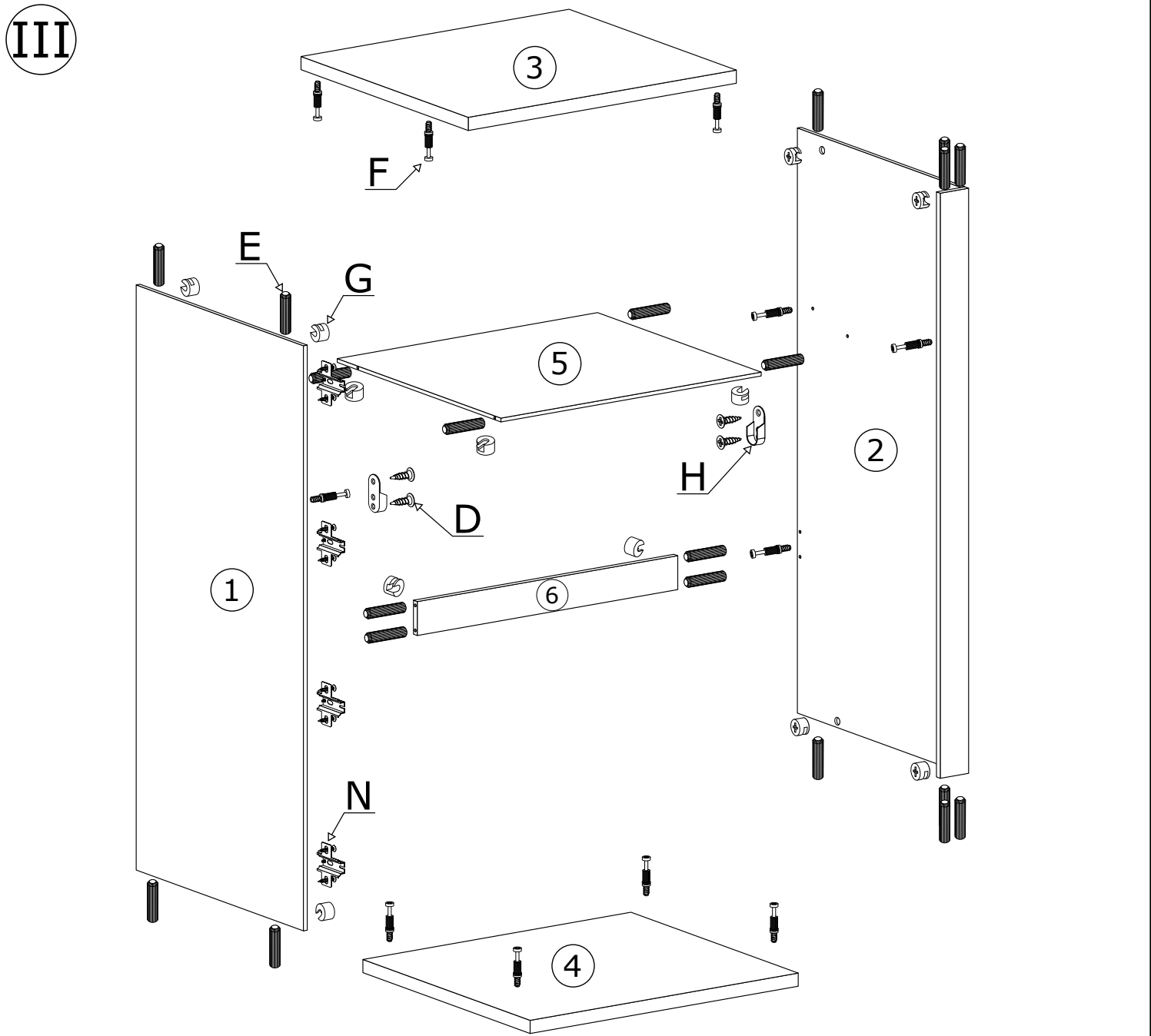
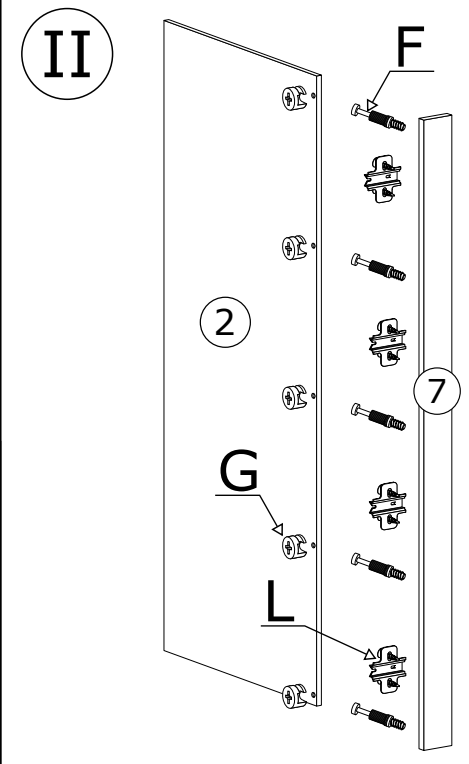
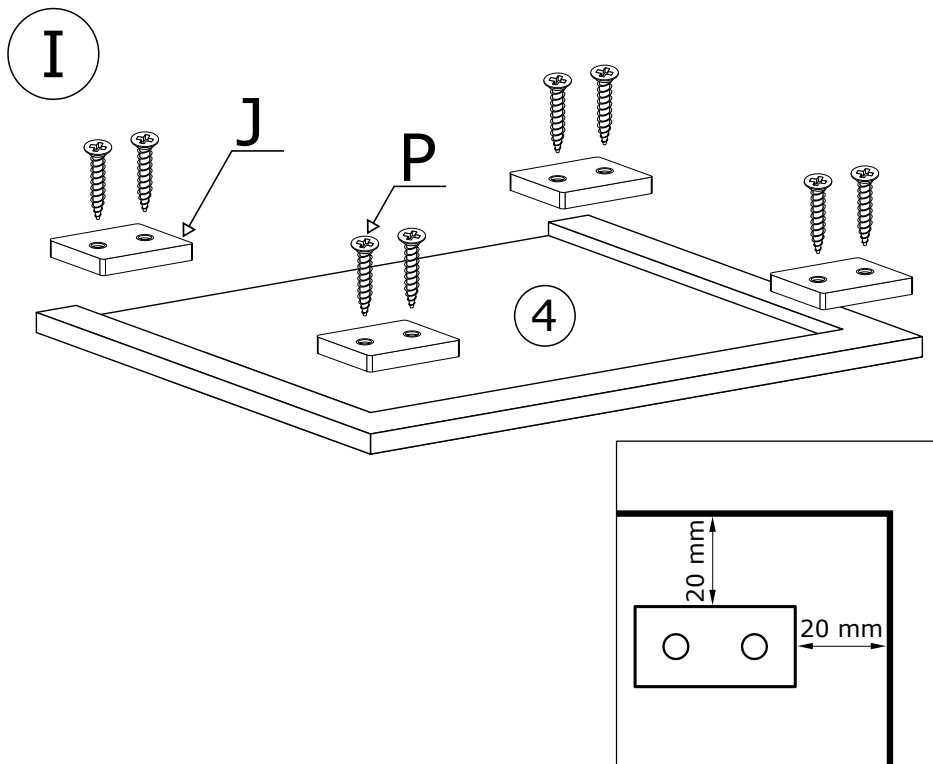

IV

x80

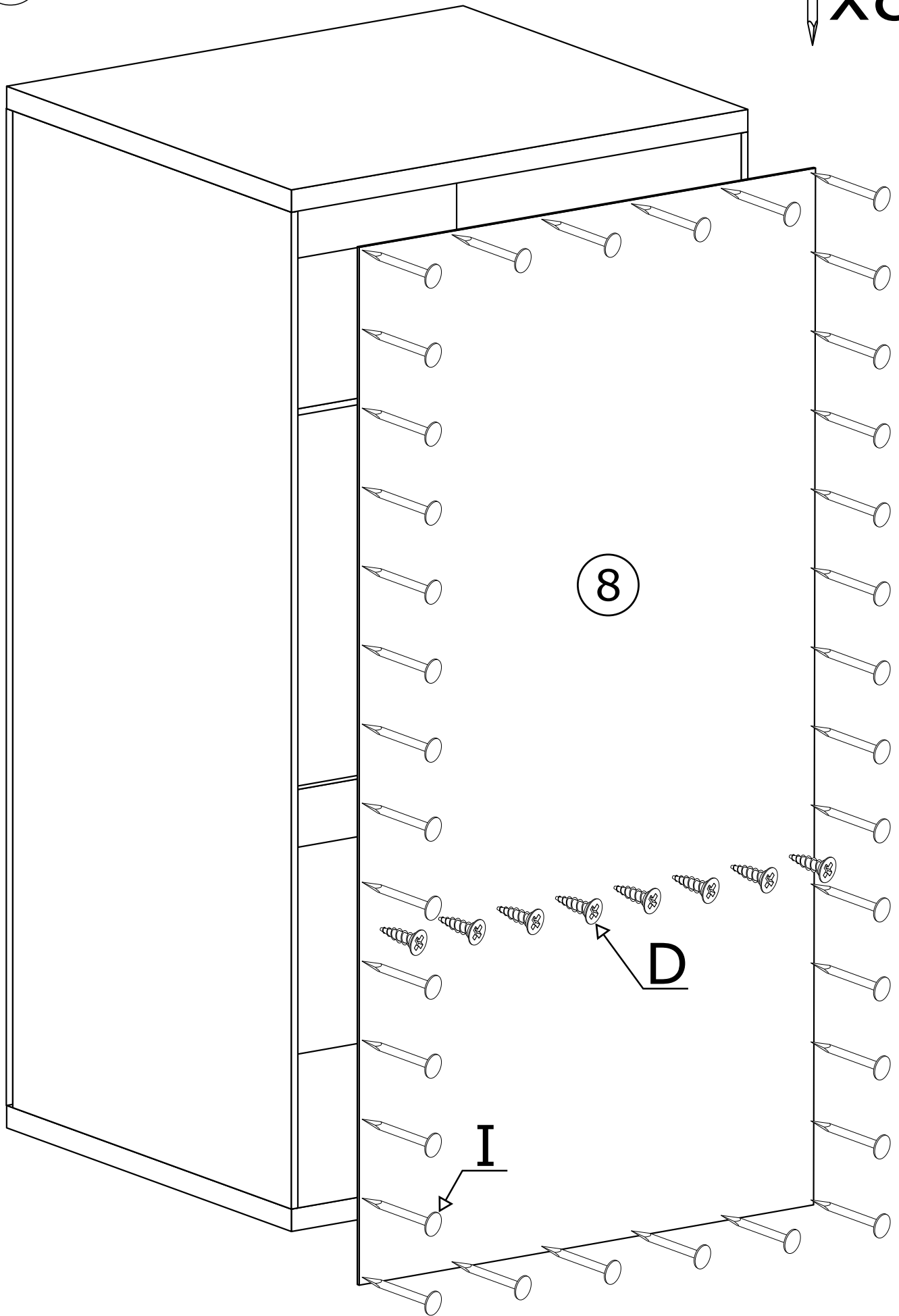

V

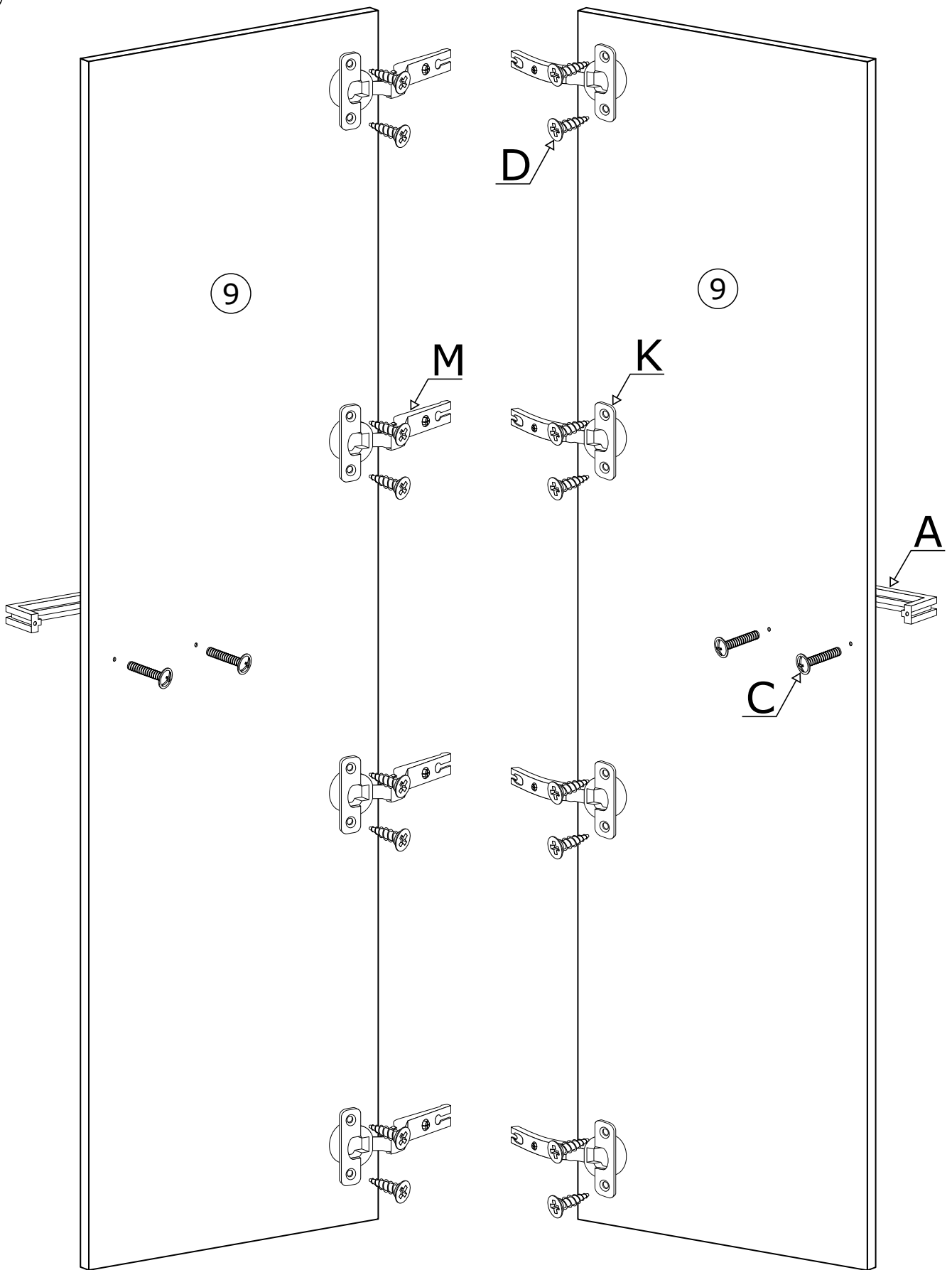

VI

