

PARIS

P-4

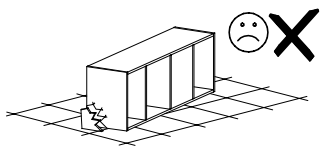

Narzędzia potrzebne do montażu

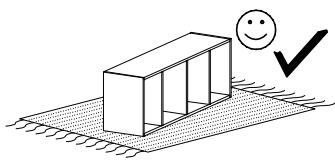
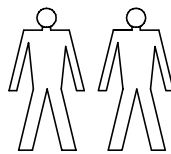
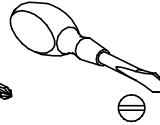
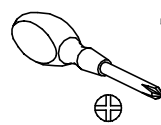
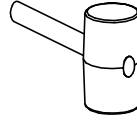
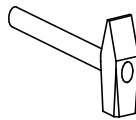

UWAGA !!

MONTOWANIE USZKODZONYCH
ELEMENTÓW POWODUJE UTRATĘ
GWARANCJI

nr	D[mm]	S[mm]	G[mm]	Ilość
1	602	436	48	1
2	602	436	48	1
3	502	370	16	2
4	1790	435	48	1
5	1790	435	48	1
6	1840	295	2,5	2
7	955	495	4	1
8	497	720	16	1
9	497	720	16	1
10	500	370	4	2

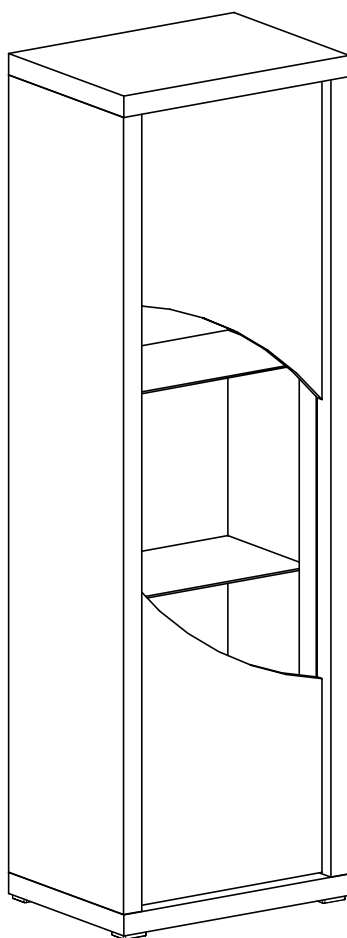

W przypadku reklamacji proszę o podanie numeru pakowacza znajdującego się na kartonie

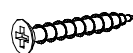

N - 8 St.
3 x 25 mm

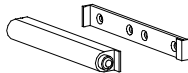

F - 1 St.

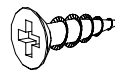

G - 18 St.
3,5 x 16 mm



L - 16 St.



E - 60 St.

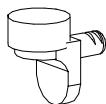

S - 9 St.

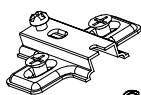

C - 4 St.

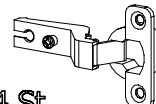

D - 4 St.

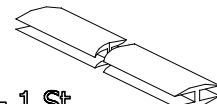

H - 1 St.

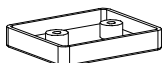

A - 4 St.



B - 16 St.

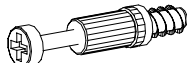

K - 16 St.

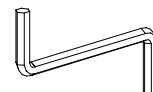

Z - 1 St.



R - 8 St.

I

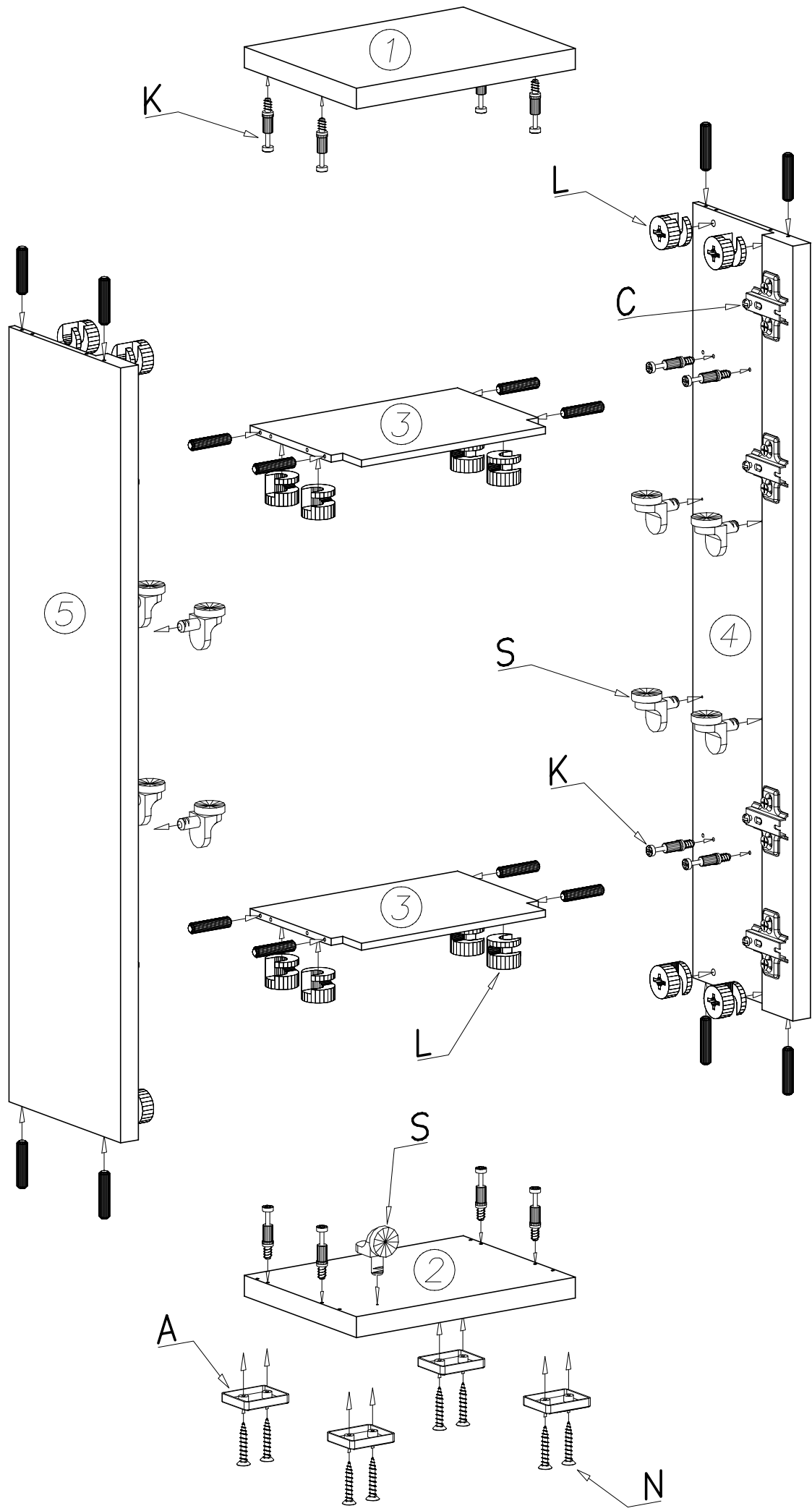

II

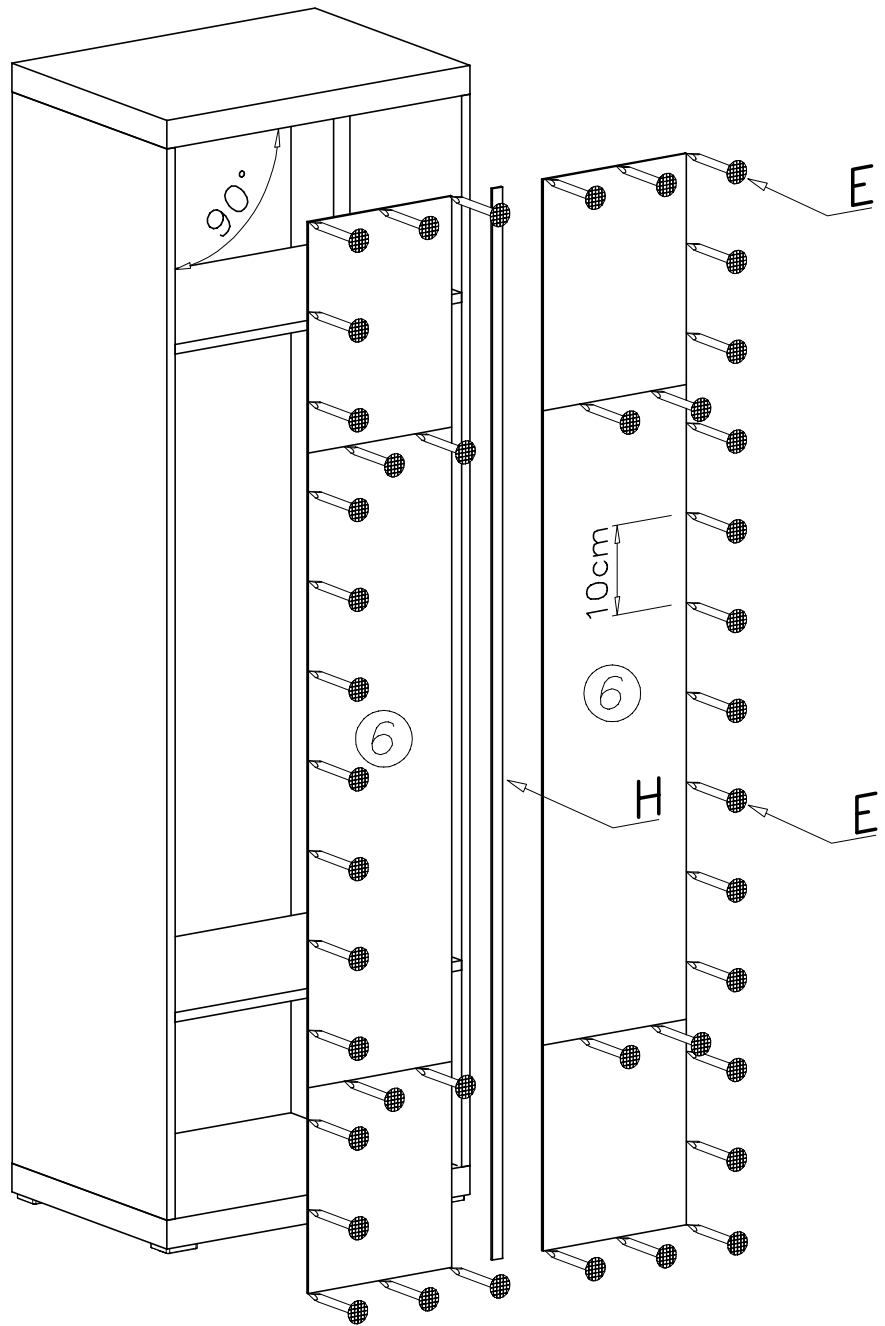

III

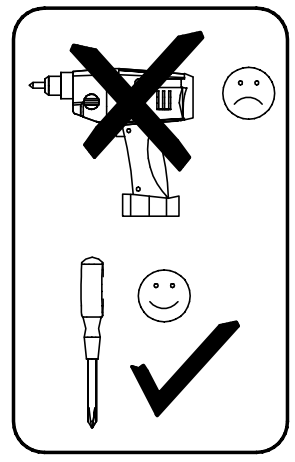
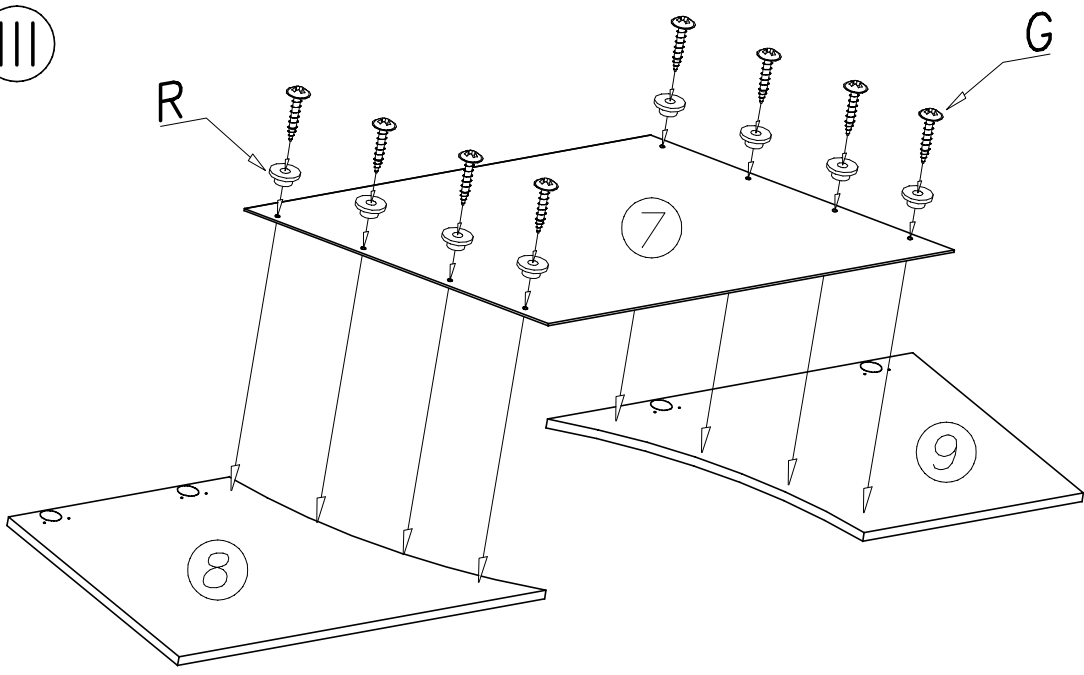

IV

