

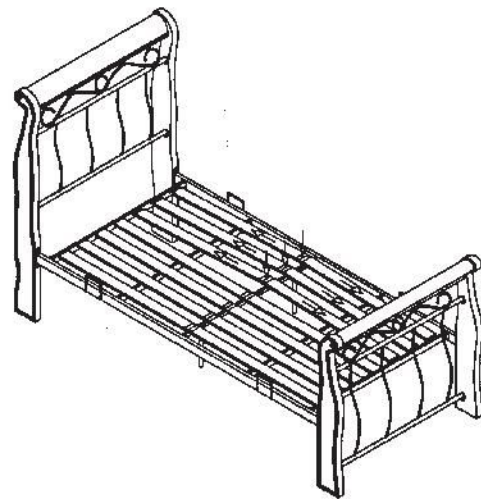

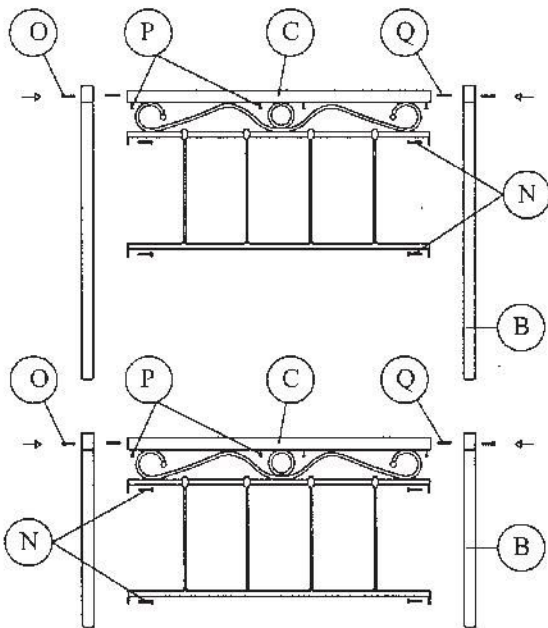

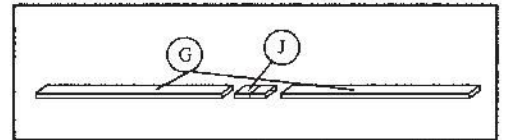

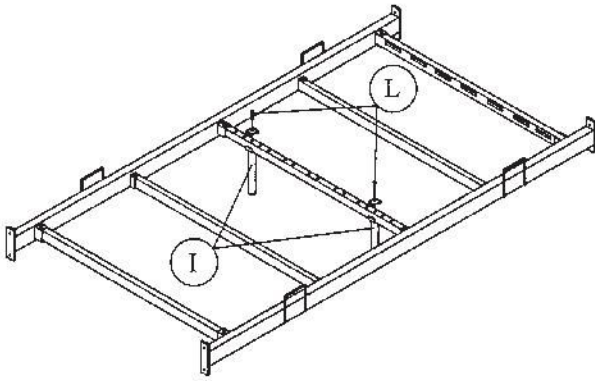

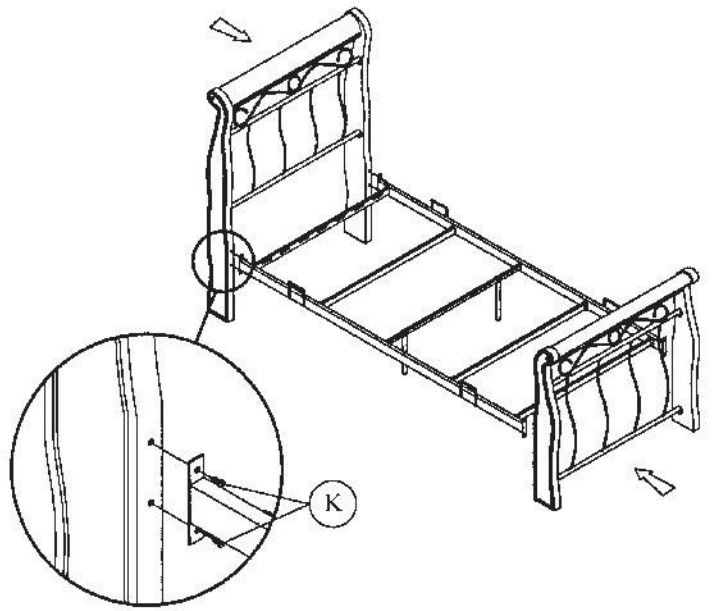
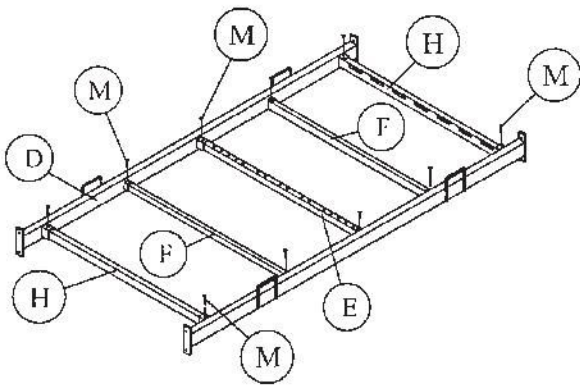
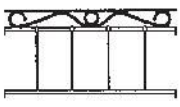

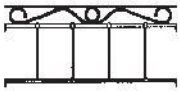
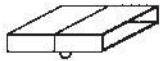



# VENECJA 90 X 200

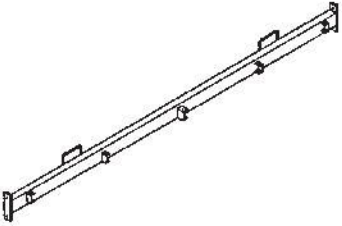

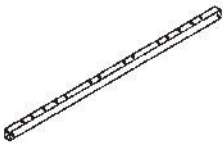
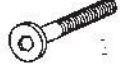
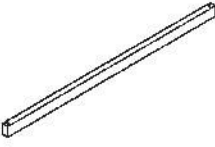
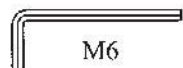
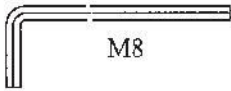
|   |   |    |   |  |    |
|---|---|----|---|--|----|
|   |   |    |   |  |    |
| A |    | 1  | I |               | 2  |
|   |    | 1  | J |               | 9  |
| B |    | 2  | K |  M8x25mm       | 8  |
|   |    | 2  | L |  M8x40mm       | 2  |
| C |   | 2  | M |  M6x40mm       | 10 |
| D |  | 2  | N |  M6x25mm     | 8  |
| E |  | 1  | O |  M6x50mm     | 4  |
| F |  | 2  | P |  #3.5 x 16mm | 8  |
| G |  | 18 | Q |  M8 x 30mm   | 4  |
| H |  | 2  | R |  M6         | 1  |
|   |   |    | S |  M8         | 1  |