

# ORLANDO

O-1

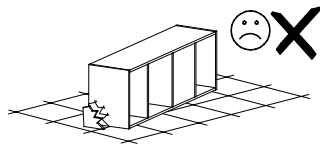

Narzędzia potrzebne do montażu

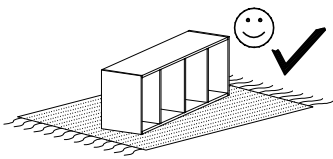
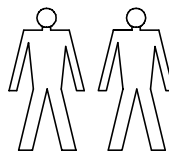
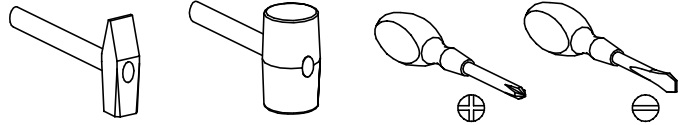

## UWAGA !!

MONTOWANIE USZKODZONYCH  
ELEMENTÓW POWODUJE UTRATĘ  
GWARANCJI

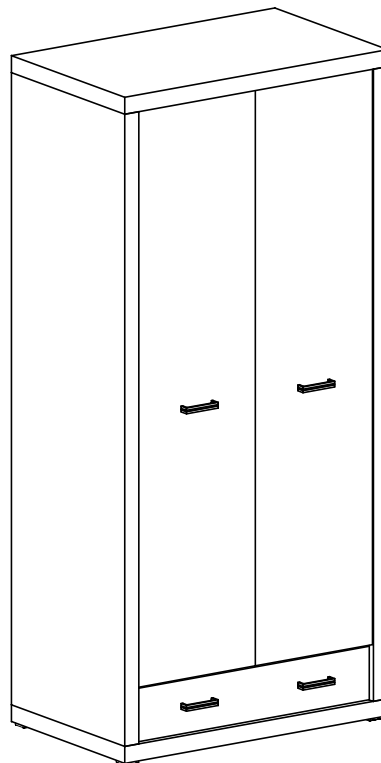

nr	D[mm]	S[mm]	G[mm]	Ilość
1	881	542	48	1
2	881	542	48	1
3	848	521	16	1
4	1790	540	48	1
5	1790	540	48	1
6	1815	436	2,5	2
7	780	190	16	1
8	500	165	16	1
9	726	165	16	1
10	500	165	16	1
11	755	505	2,5	1
12	388	1590	16	1
13	388	1590	16	1

W przypadku reklamacji proszę o podanie numeru pakowacza znajdującego się na kartonie

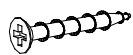

P - 8 St.  
3,9 x 25 mm

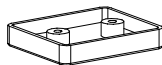

W - 4 St.

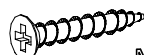

M - 20 St.  
3 x 30 mm

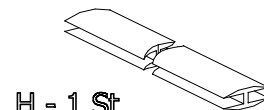

H - 1 St.

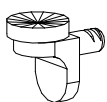

P - 2 St.



O - 1 St.



U - 4 St.

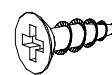

G - 16 St.  
3,5 x 16 mm

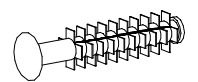

F - 4 St.

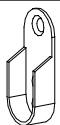

A - 2 St.

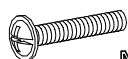

N - 12 St.  
M4 x 25 mm

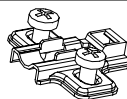

C1 - 2 St.

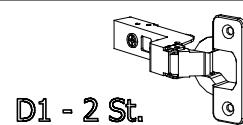

D1 - 2 St.

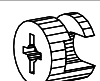

L - 16 St.

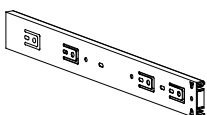

T - 1 Kpl.

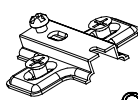
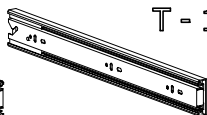

C2 - 4 St.

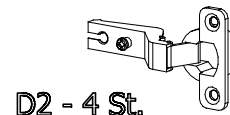

D2 - 4 St.



S - 1 St.



E - 60 St.

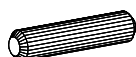

B - 20 St.

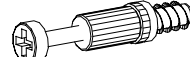

K - 16 St.

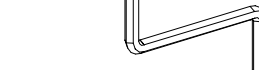

Z - 1 St.



J - 8 St.  
5 x 13 mm

I

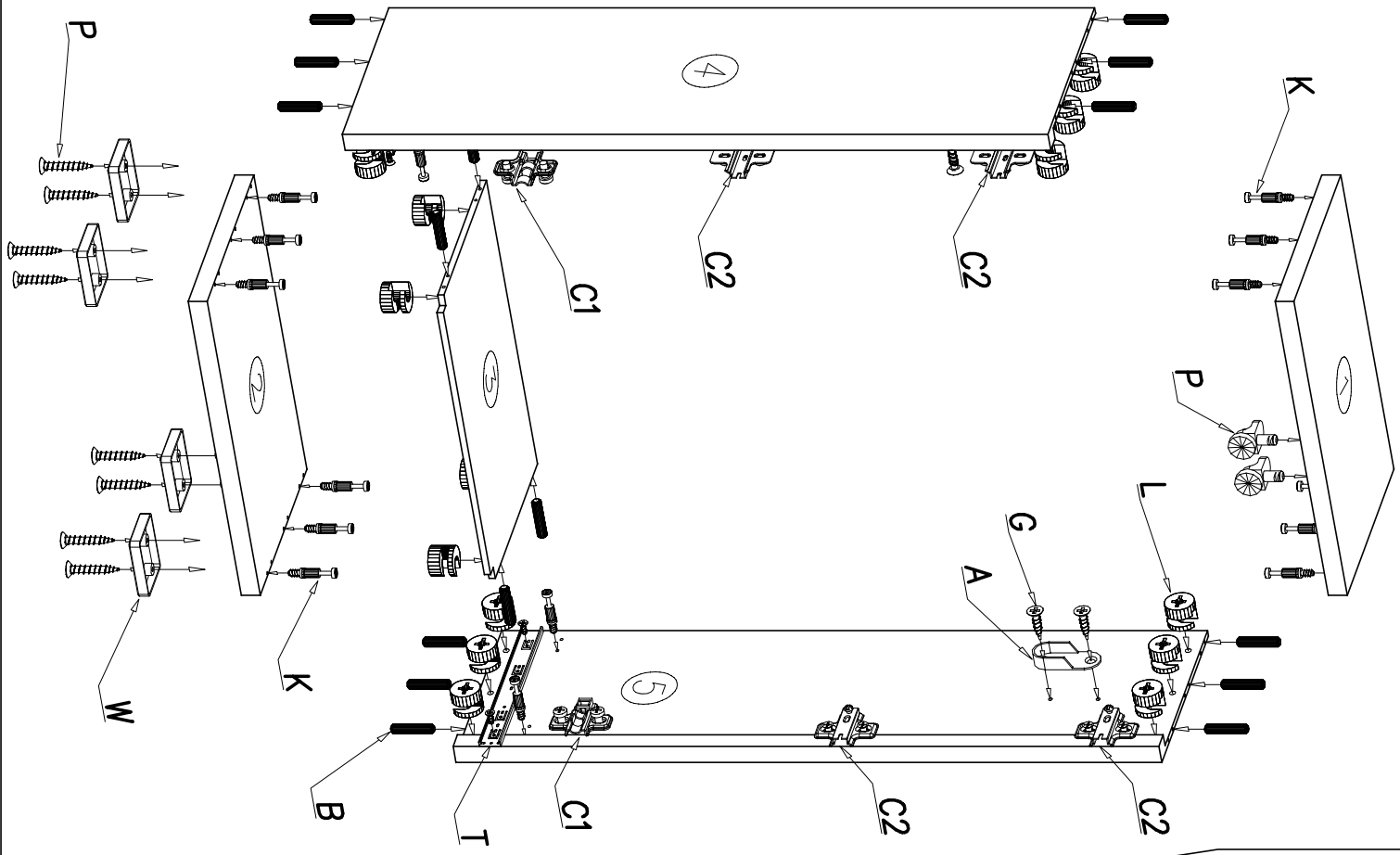

II

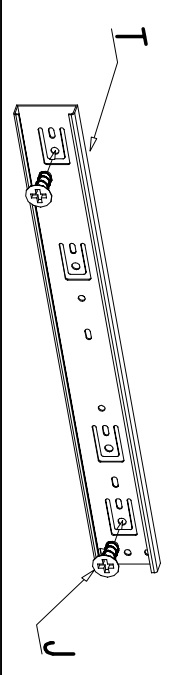
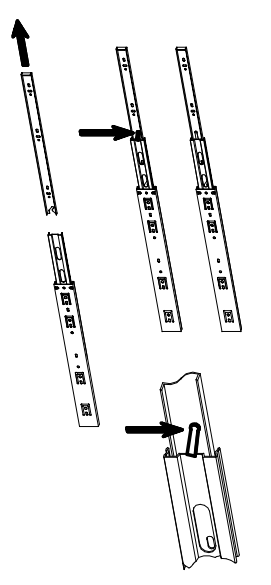
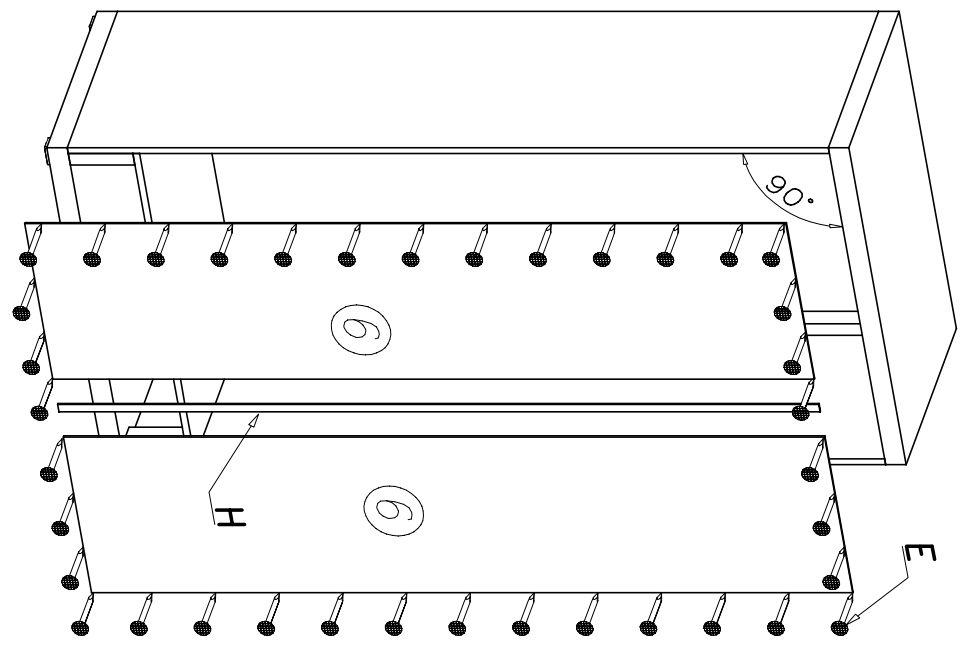

III

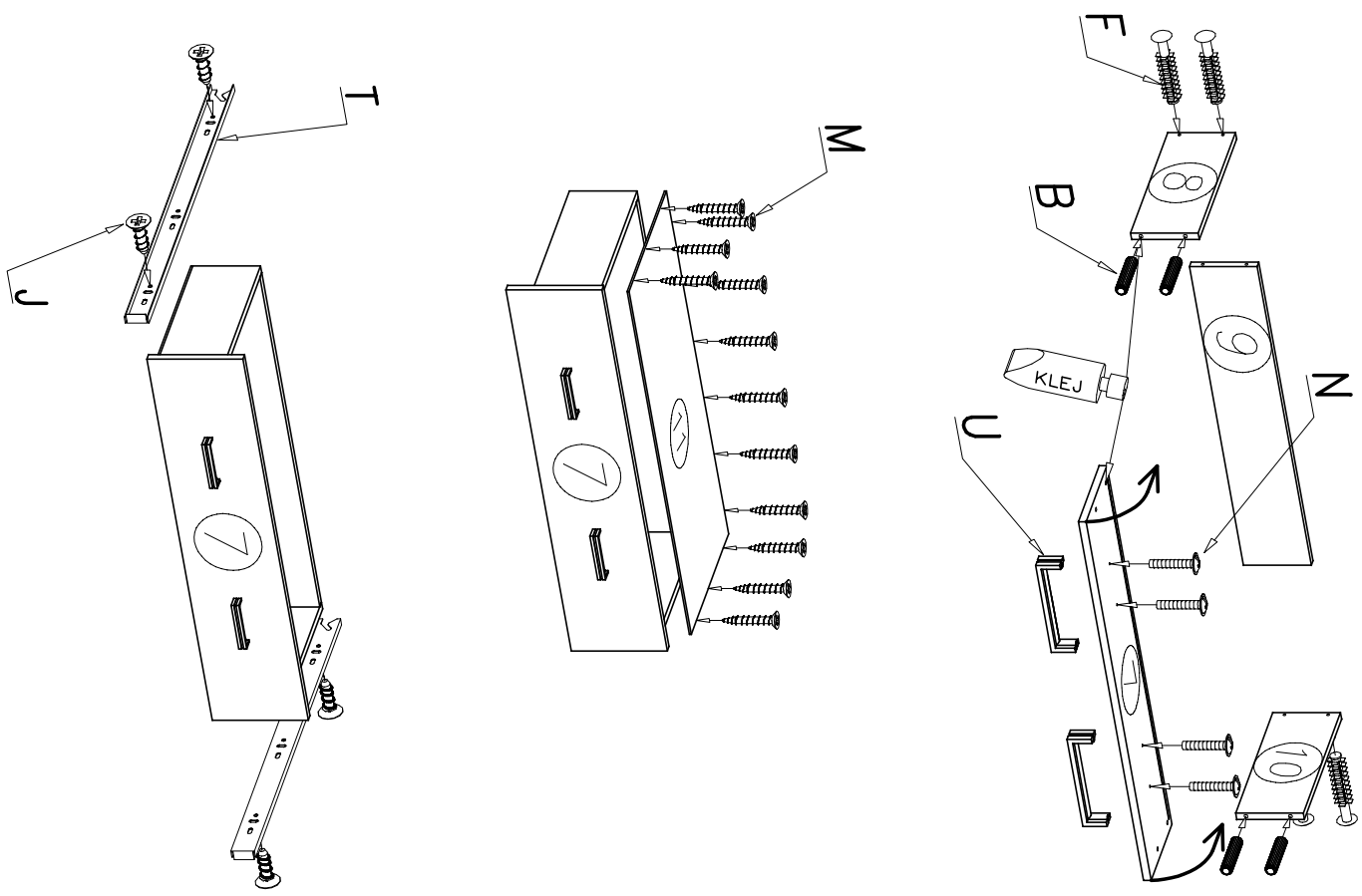

IV

