

ORLANDO 18

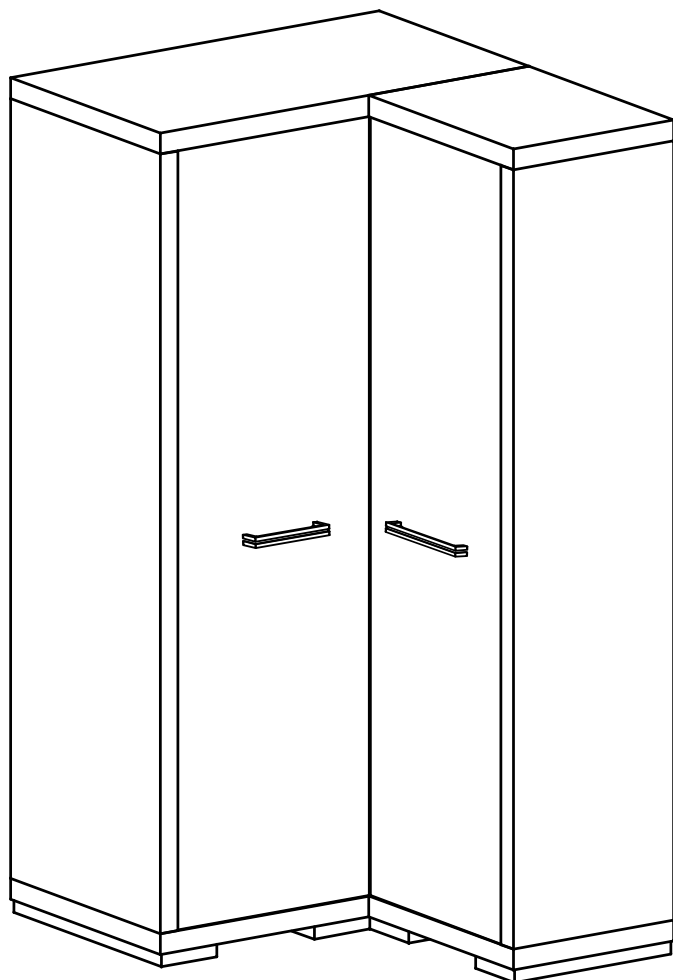

Narzędzia potrzebne do montażu



UWAGA !!!

MONTOWANIE USZKODZONYCH
ELEMENTÓW POWODUJE UTRATĘ
GWARANCJI

Nr	D[mm]	S[mm]	G[mm]	Ilość
1	550	405	48	1
2	955	540	48	1
3	955	540	48	1
4	550	405	48	1
5	1790	405	48	1
6	1790	540	48	1
7	1790	405	16	1
8	1790	400	16	1
9	922	400	16	1
10	922	80	16	1
11	1815	950	2,5	1
12	1815	740	2,5	1
13	1782	495	16	1
14	1782	495	16	1
15	532	320	16	4

W przypadku reklamacji proszę podać numer pakowacza znajdujący się na kartonie.

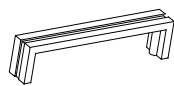

U - 2 St.



Y - 2 St.

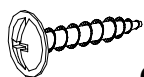

Q - 4 St.
3,5x16 mm

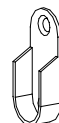

T - 2 St.

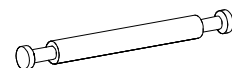

F - 6 St.

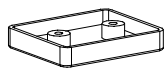

A - 8 St.

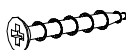

O - 16 St.
3,9x25 mm



M - 1 St.



G - 40 St.
3,5x16 mm

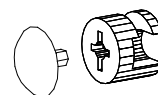

L - 30 St.

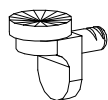

I - 4 St.



N - 4 St.
4x30 mm

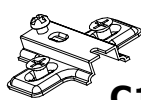

C1 - 4 St.

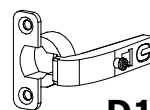

D1 - 2 St.

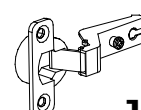

J1 - 2 St.

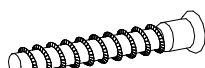

W - 4 St.

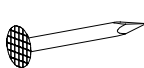

E - 100 St.

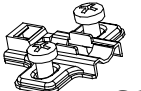

C2 - 4 St.

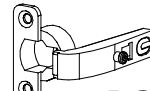

D2 - 2 St.

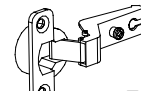

J2 - 2 St.



P - 20 St.



B - 20 St.

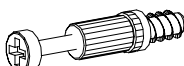

K - 18 St.



Z - 1 St.



S - 6 St.

I

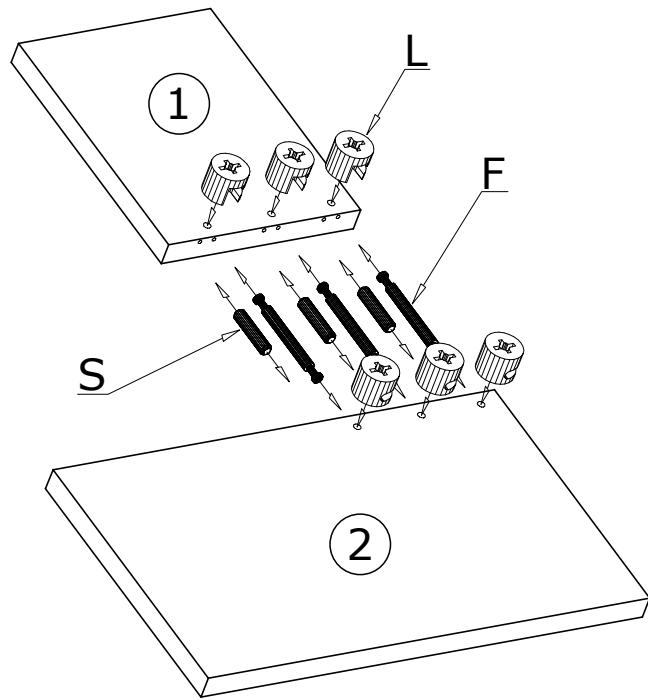

II

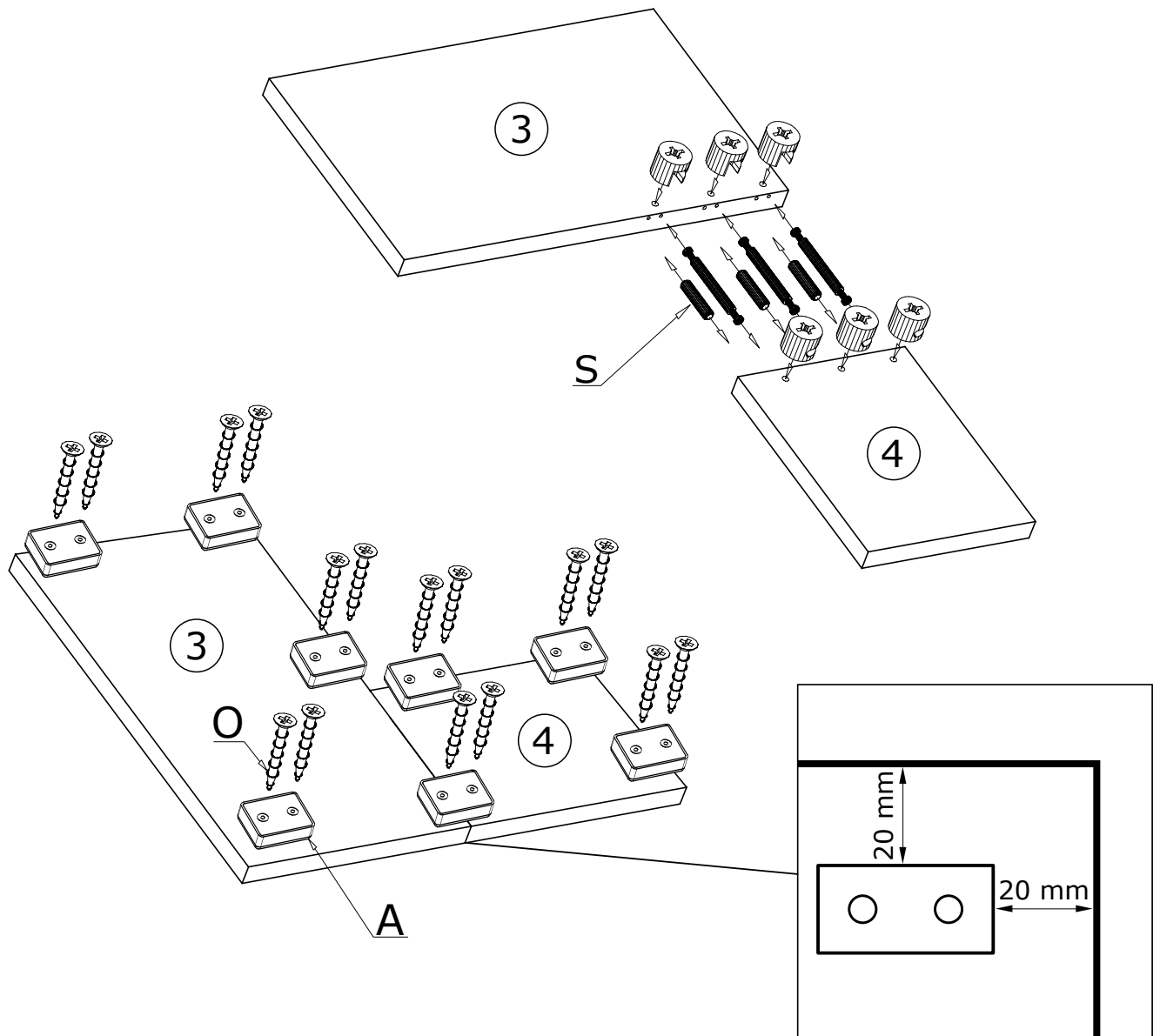

III

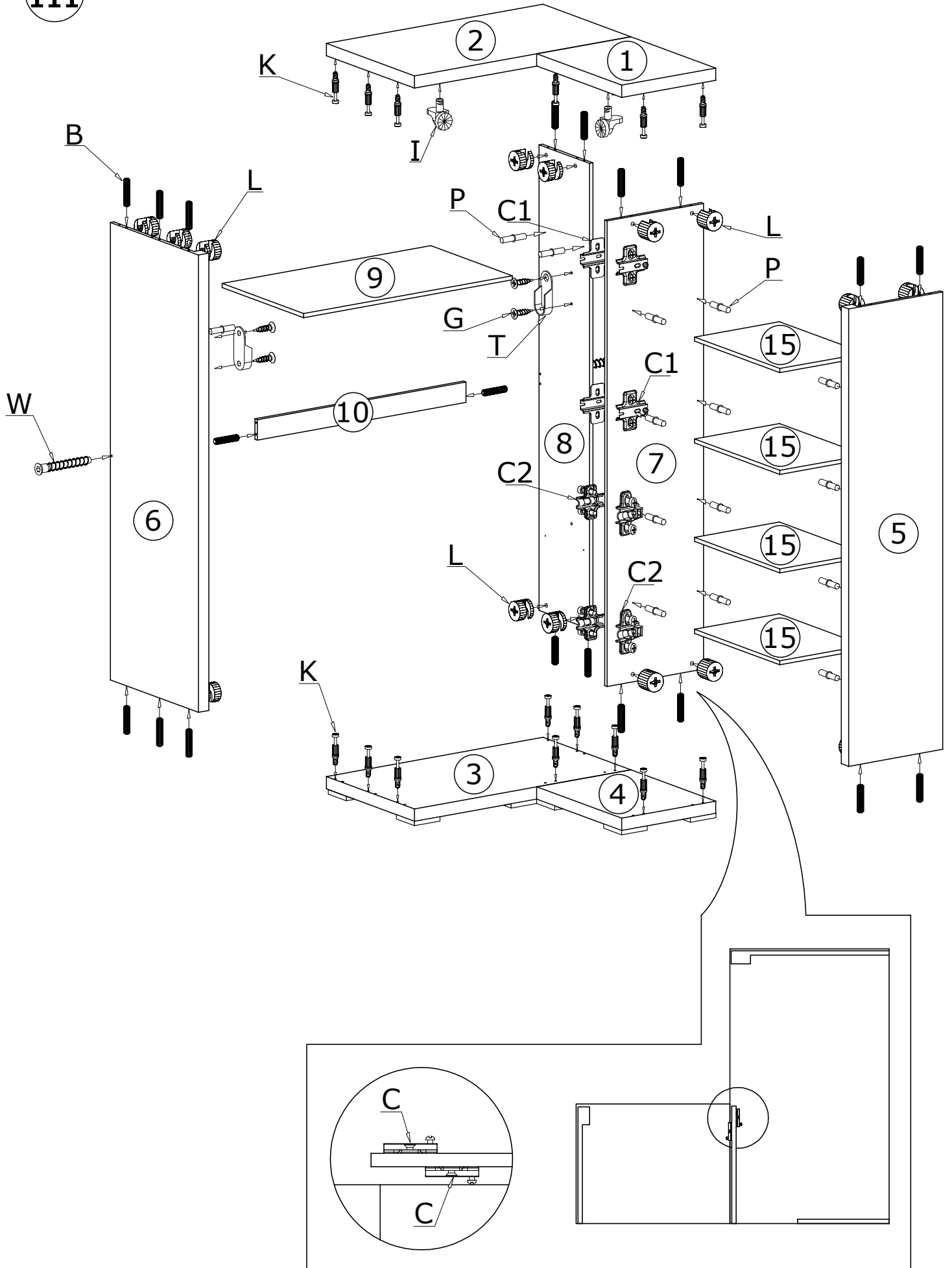

IV

100X 

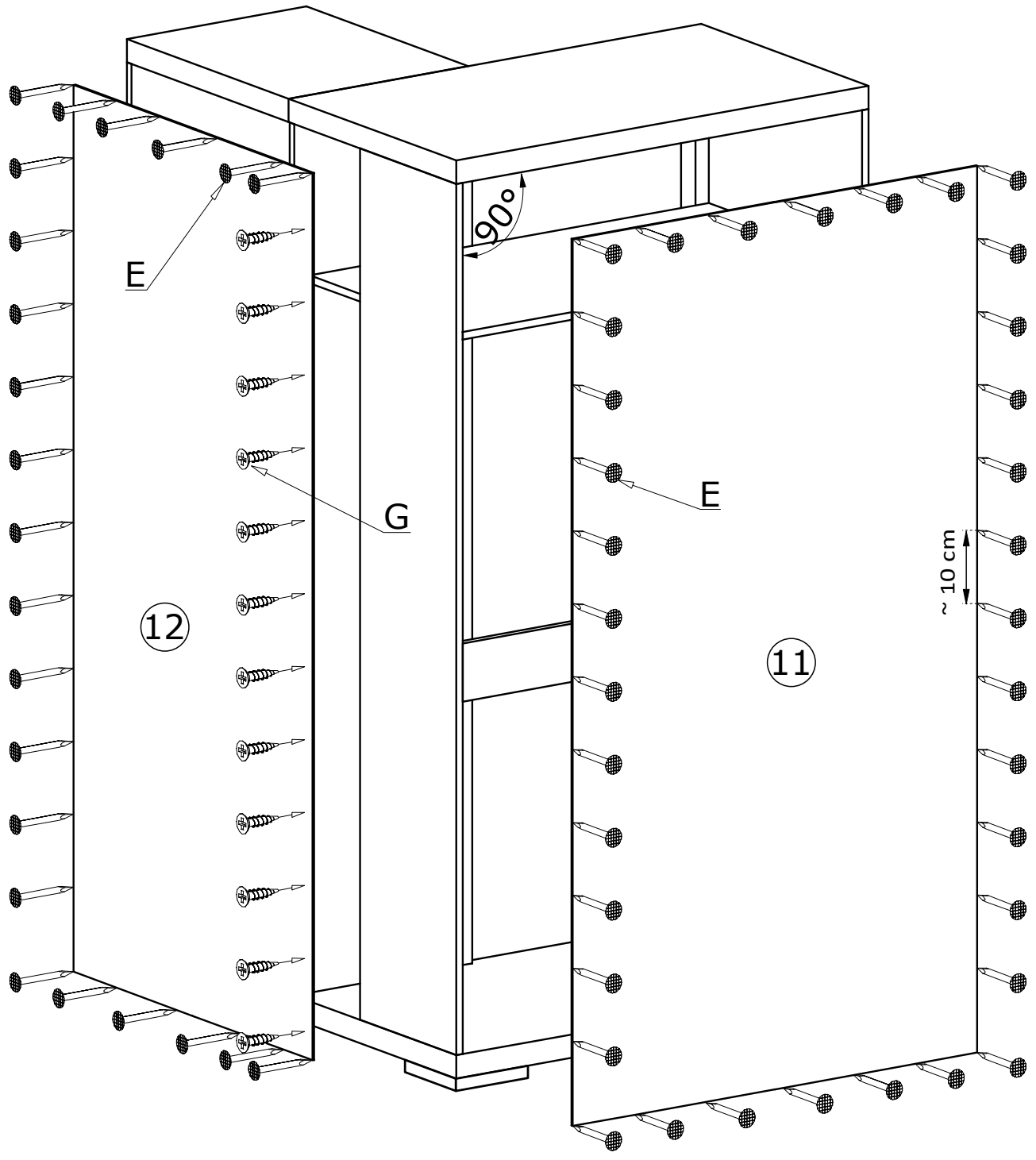

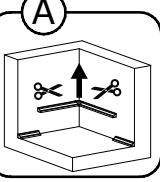
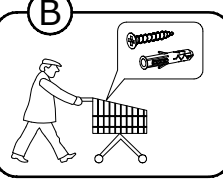
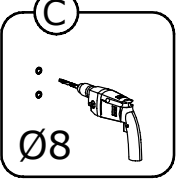
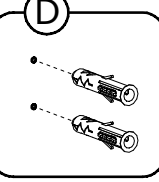
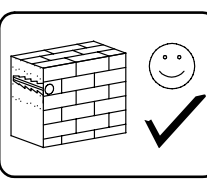
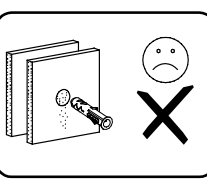
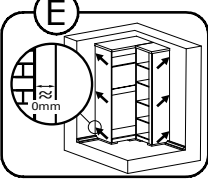
A  **B**  **C**  **D**    **E** 

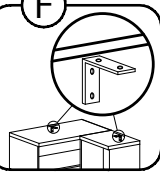
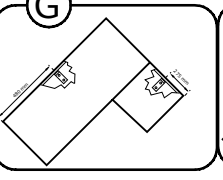
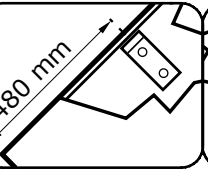
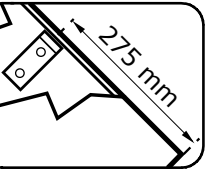
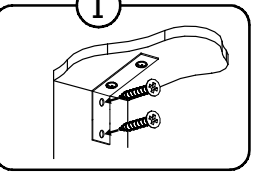
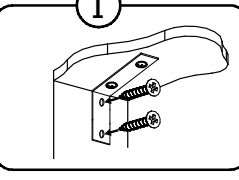
F  **G**   **H**  **I**  **J** 

V

