

JM 13

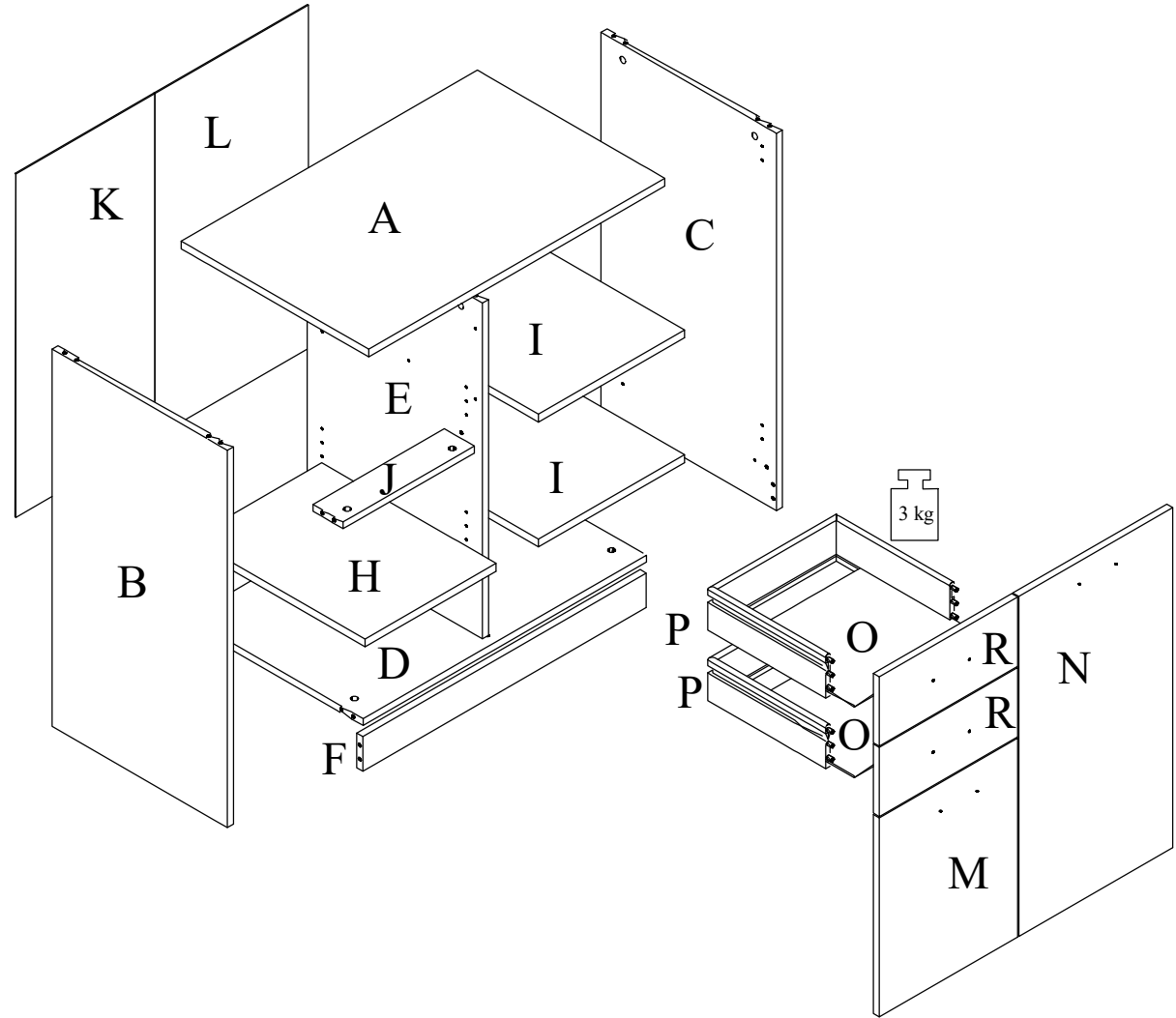

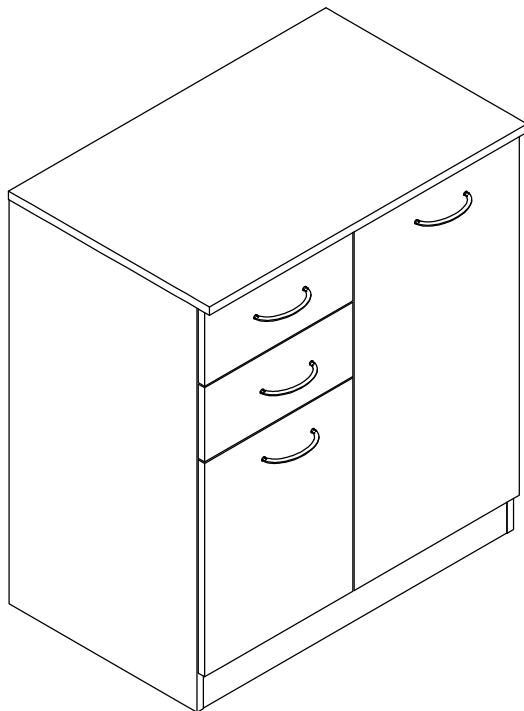
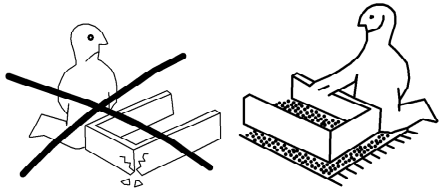
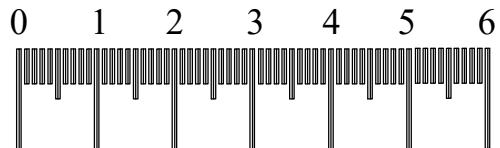

0013K	1x	0001K	18x	0018K	12x	0019K	12x	0002V	8x
		8x40						3,5x16	

0005V	2x	0011K	1x	0016K	30x	0001V	16x	0009K	12x
7x50						4x16			

0015K	4x	0014K	4x	0006K	4x	0004V	8x	0003V	14x
				M4x10		M4x20		3x16	

0017U	4x	0002K	5x	0060K	4x	0054K	6x

0024K	4x
-------	----

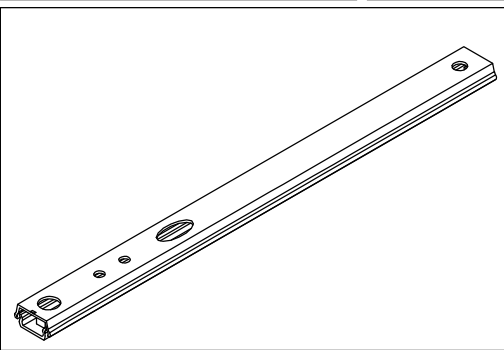

1.)

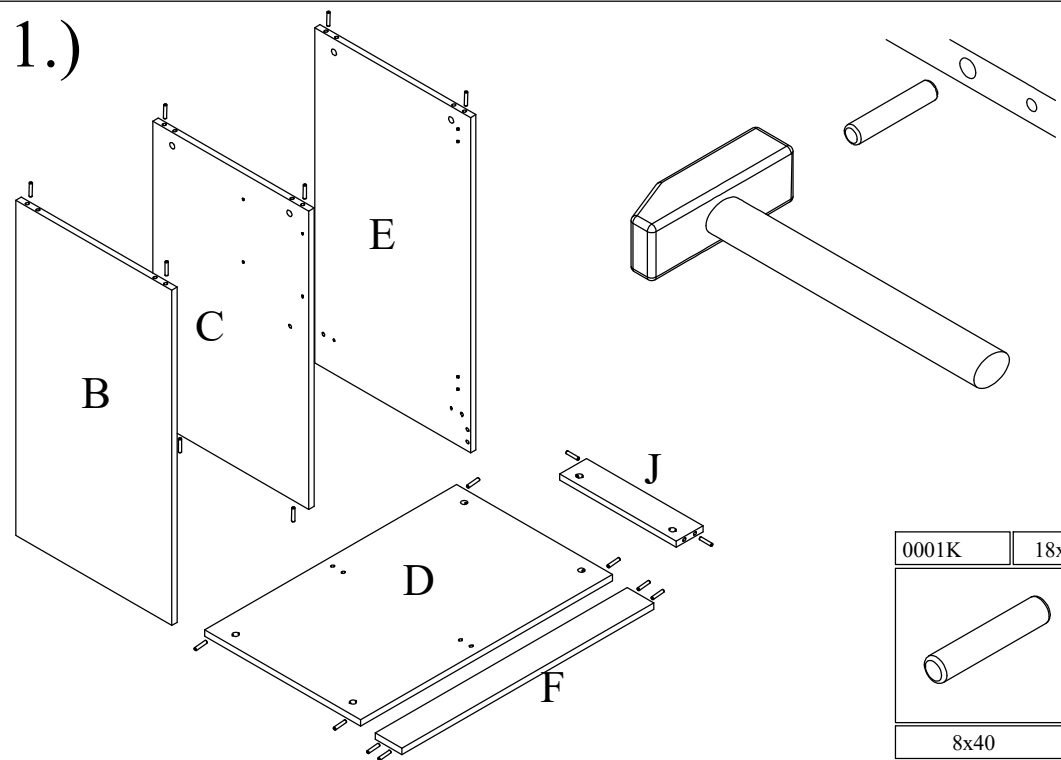

2.)

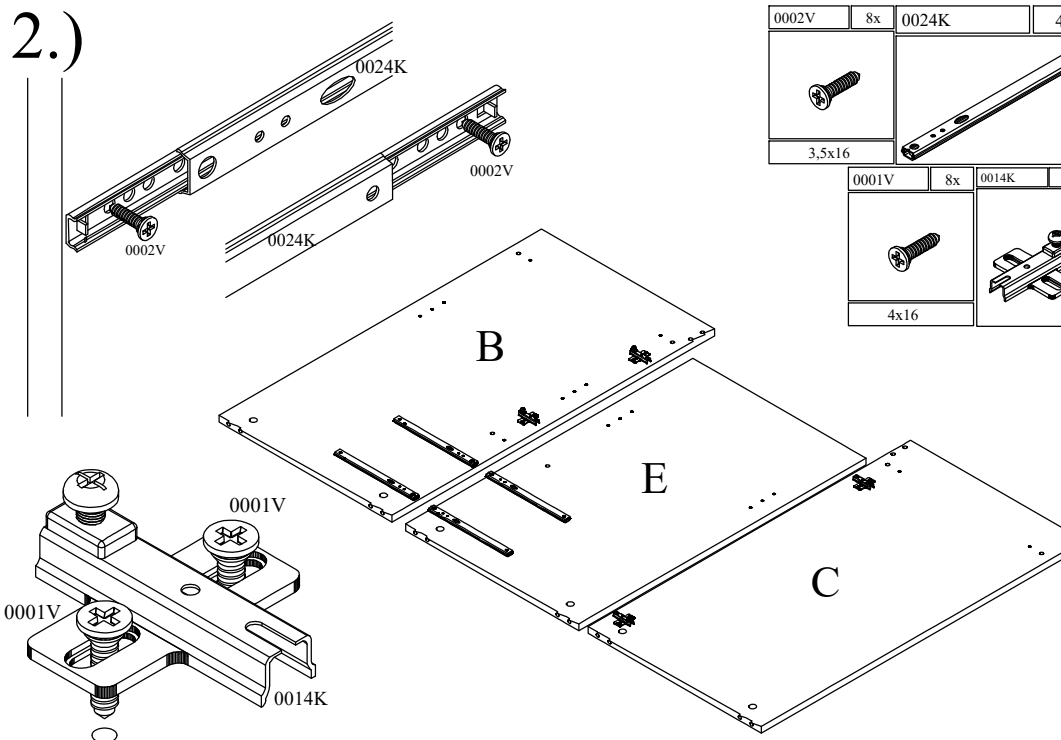

3.)

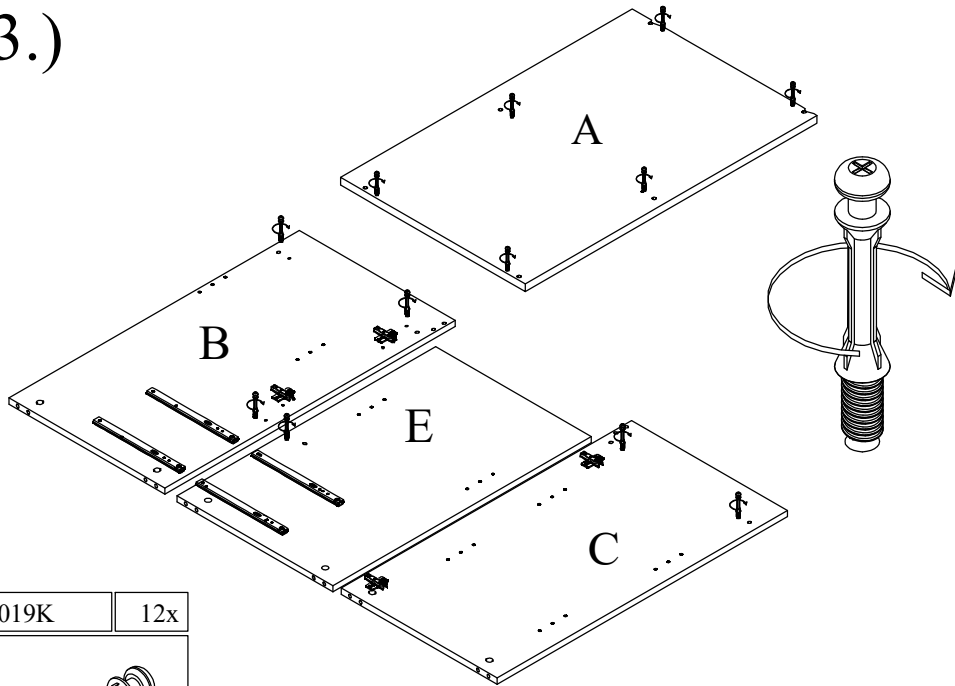

0019K 12x

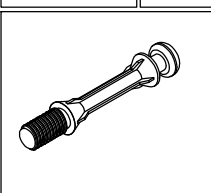

4.)

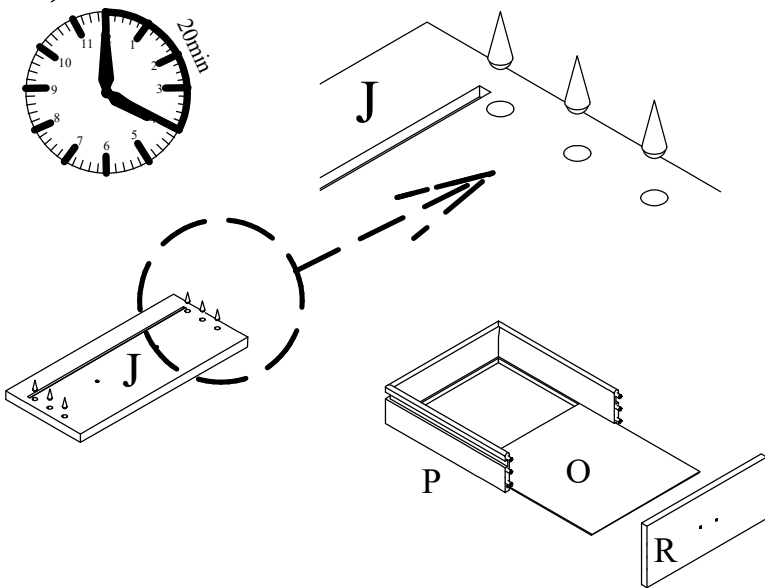

0011K 1x

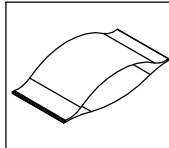

5.)

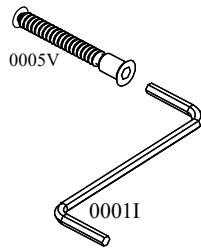
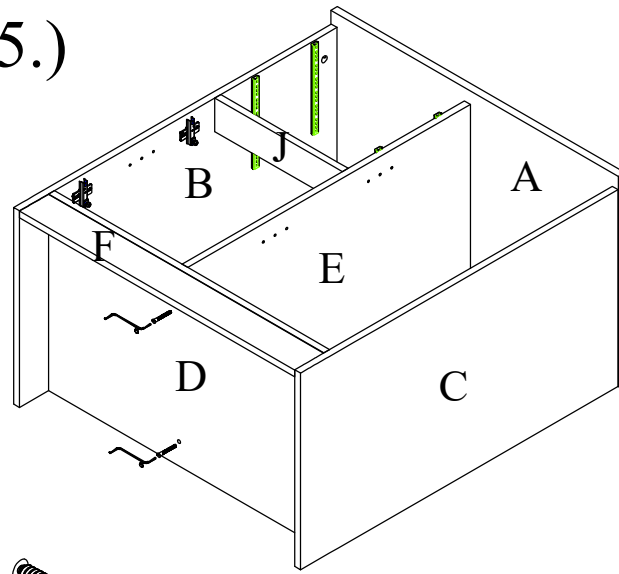

0005V

0001I

0002K 5x

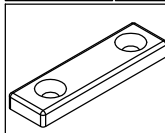

0003V 14x



3x16

0060K 4x

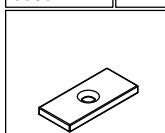

0013K	1x	0018K	12x	0005V	2x
7x50					

0054K	6x

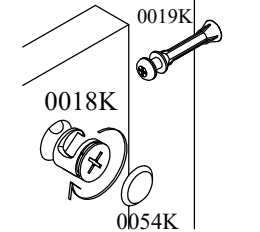

0019K

0018K

0054K

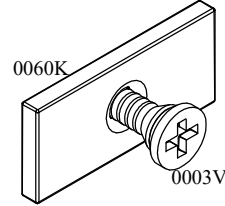

0060K

0003V

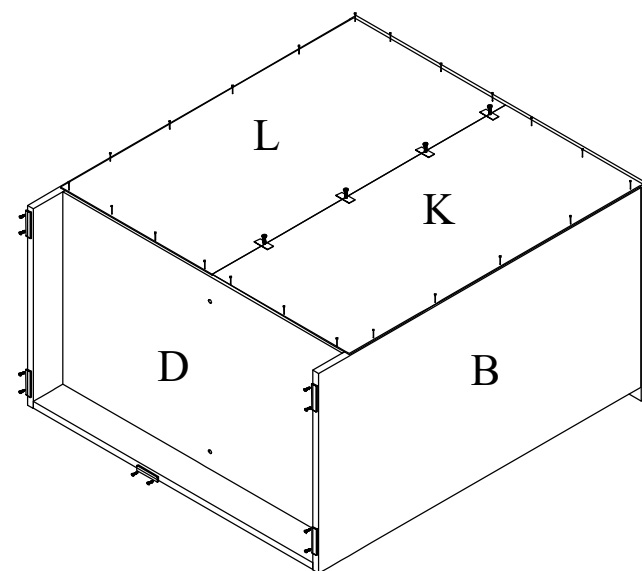

0016K 30x

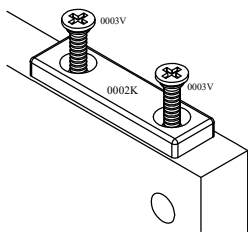
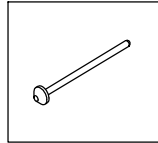

0003V

0002K

0003V

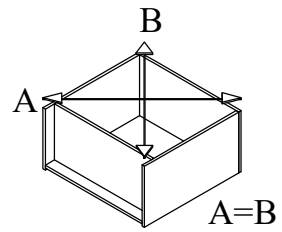

A=B

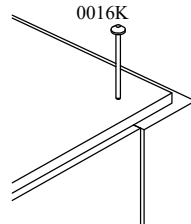

0016K

