

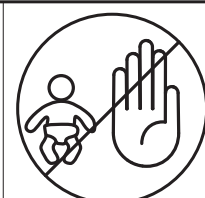

- (GB) Assembly instructions
- (DE) Montageanleitung
- (FR) Notice de montage
- (NL) Handleiding voor de montage
- (IT) Istruzioni di montaggio
- (HU) Szerelési útmutató
- (ES) Instrucciones de montaje
- (PL) Instrukcja montażu
- (CZ) Montážní návod
- (SK) Návod na montáž
- (HR) Montaže
- (TR) Montaj talimat
- (RO) Instrucțiuni de montaj
- (RU) Инструкции по монтажу

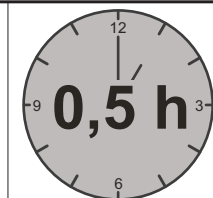
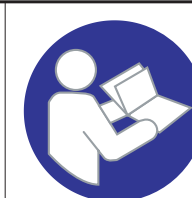
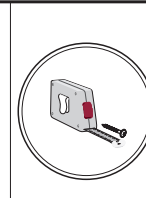
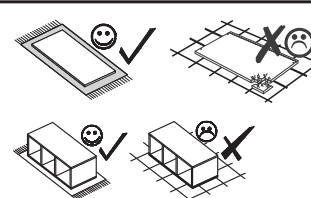
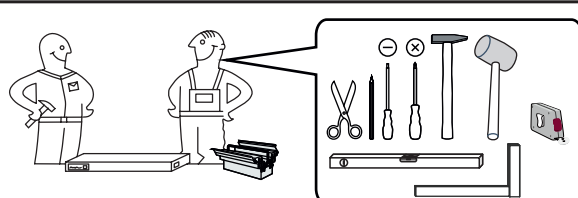
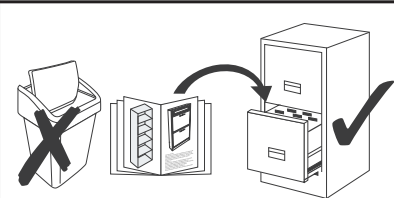
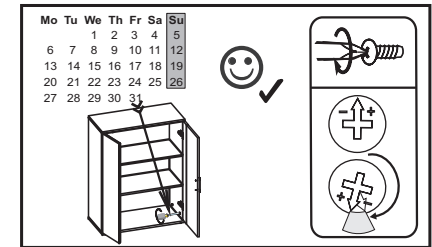
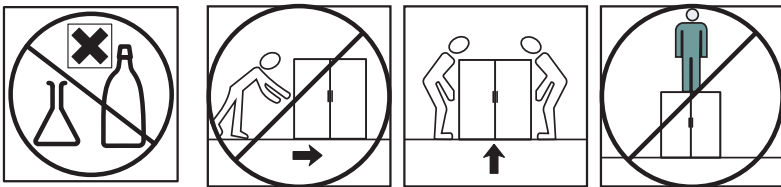
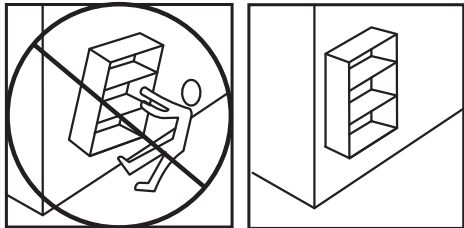
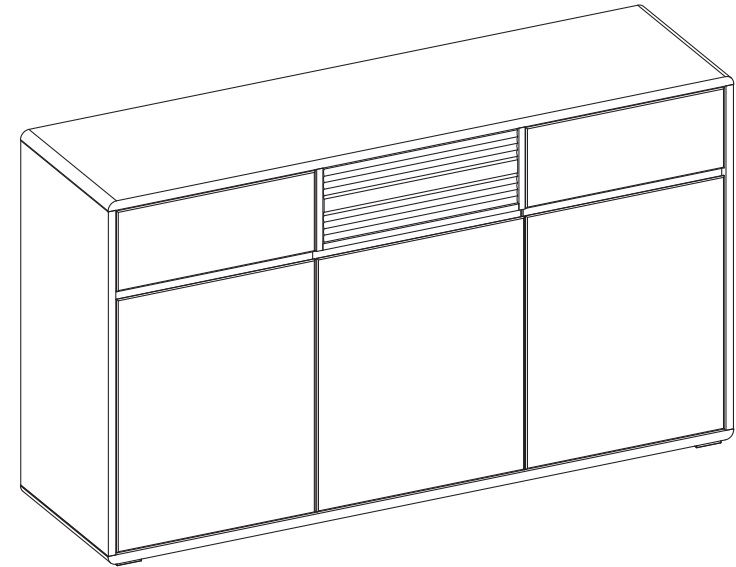

Service • Assistenza • Dienstverlening • Serwis Servis • Szerviz • Servizio • Usluga • Níðáčníř • Nöóćár

Name • Nom • Nome • Naam • Nazwa Jméno • Názov • Név • Denumire Nombre • Ime • Isim • Írfáríćí	BELLIS
Nr. • No. • N° • říěłđ • Ć • Sz • Ne	SIMD34..
Typ • Type • Tip • Tipus • Tipo • Ńćđ	47

shop • geschäft • boutique • sklep • winkel • ěřárĉí
negozio • bolt • tienda • obchod • dućan • mađaza • magazin

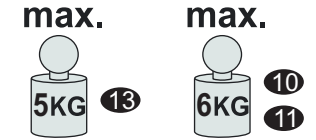
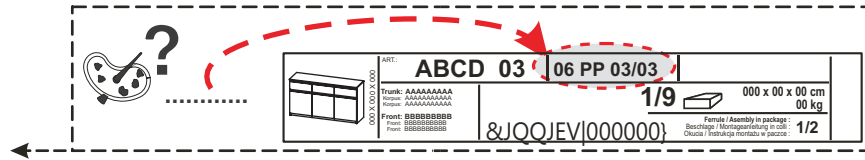
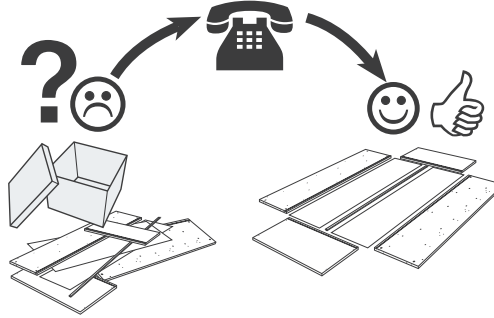

T1 X...	Z1 fi 35 KR15 X...	W10 X...	K1 L-50 mm X...
M1 X...	Z1s fi 35 KR15 X...	P2 3x16 X...	E6 6x9,5 X...
B1 fi 8x28 X...	Z18 fi 35 KR8 X...	L1 X...	F51 L-350 mm X...
B26 fi 8x32 X...	D19 H2 X...	R38 Quadro L 350 X...	P10 3x13 X...
B27 fi 8x22 X...	S9 4x16 X...	S4 3x16 X...	
S11 4x25 X...			
P6 4x35 X...			

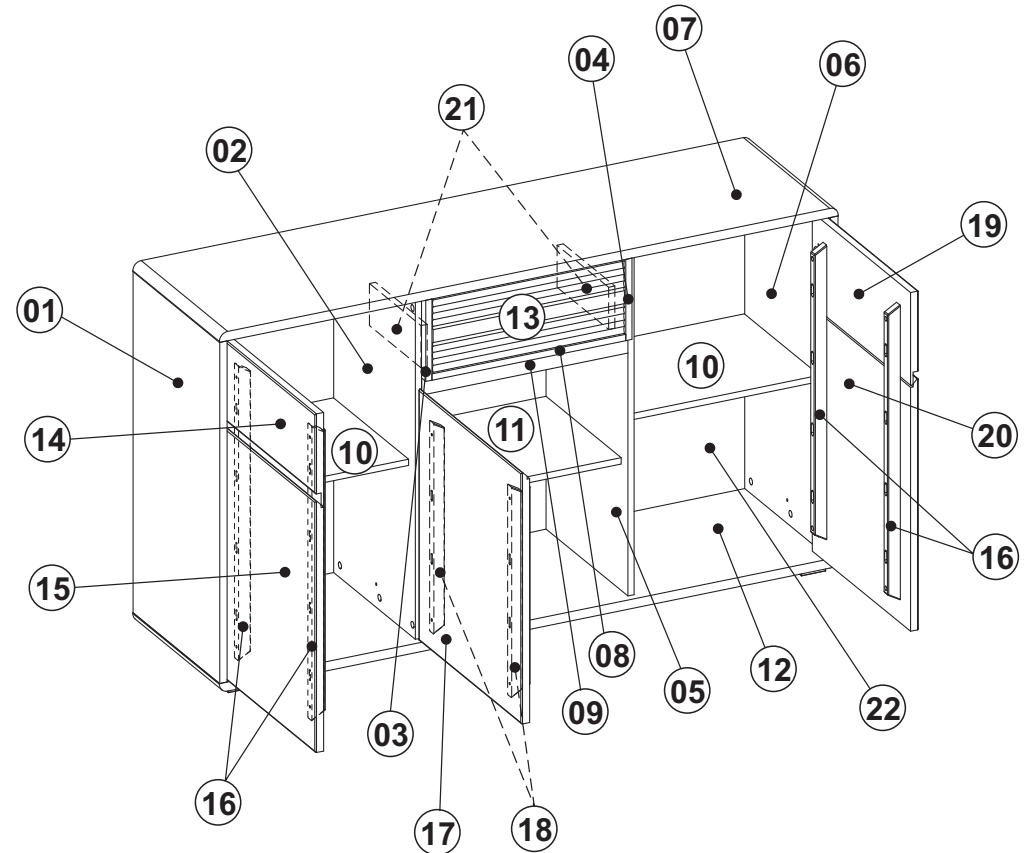

1

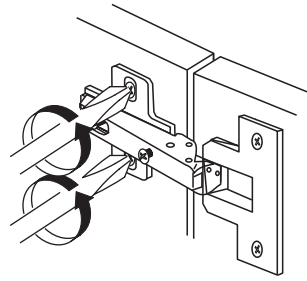
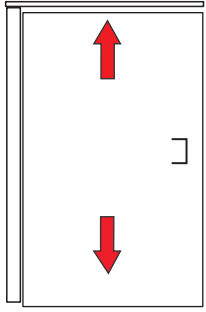

2

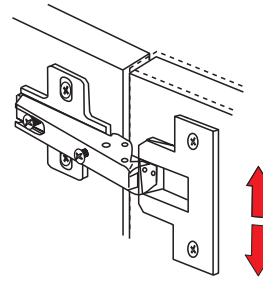

3

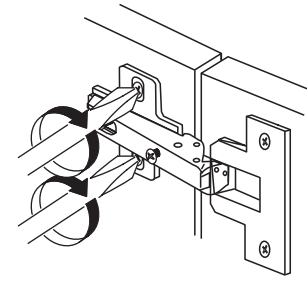

1

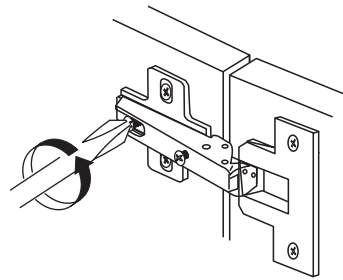
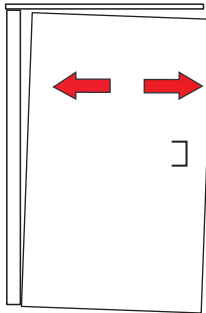

2

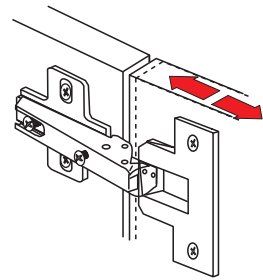

3

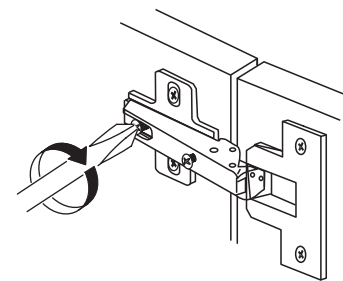

1

