

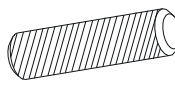

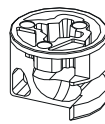





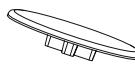
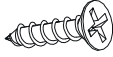
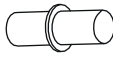
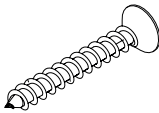
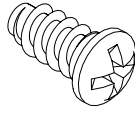
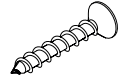
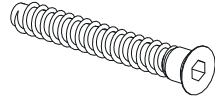
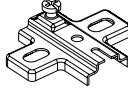
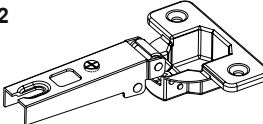
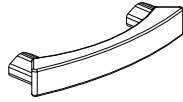
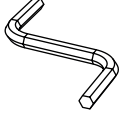
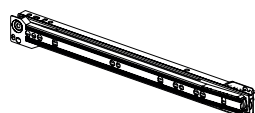
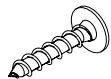
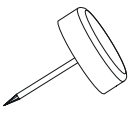
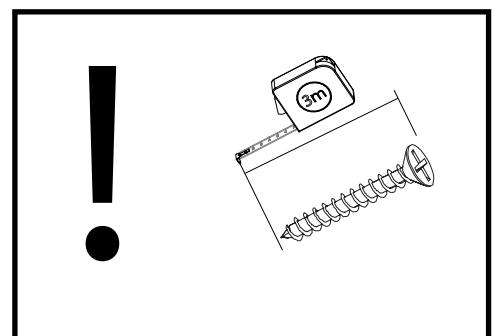

BIU 01-01

GW1 x 18 1,4x25 	K1 x 16 8x32 	B2 x 22 h-12 
ZJ1 x 22 L-43 	ZM1 x 6 Ø18 	WT1 x 10 3,5x15 
PO2 x 4 Ø5 	WT18 x 4 4x30 	WE2 x 4 EK6,3x13B 
WT35 x 6 3x20 	KT1 x 2 6,3x50 	PK1 x 2 H-0 
ZP5 x 2 NAKL 	U5 x 2 L-96 	x 1 
P5 x 1 	WT9 x 3 3x16 	SG1 x 6 



BIU 01-01

	CODE				
1	BIU0101HDF_01	307	569	1	1/1
2	BIU0101_08	112	350	2	1/1
3	BIU0101_05	280	443	2	1/1
4	BIU0101HDF_02	250	354	1	1/1
5	BIU0101_10	408	307	1	1/1
6	BIU0101_07	307	160	1	1/1
7	BIU0101_12	524	100	1	1/1
8	BIU0101_02	720	444	1	1/1
9	BIU0101_04	615	444	1	1/1
10	BIU0101_06	279	428	1	1/1

	CODE				
11	BIU0101_03	720	444	1	1/1
12	BIU0101_09	223	112	1	1/1
13	BIU0101_11	524	200	1	1/1
14	BIU0101_01	890	550	1	1/1
15					
16					
17					
18					
19					

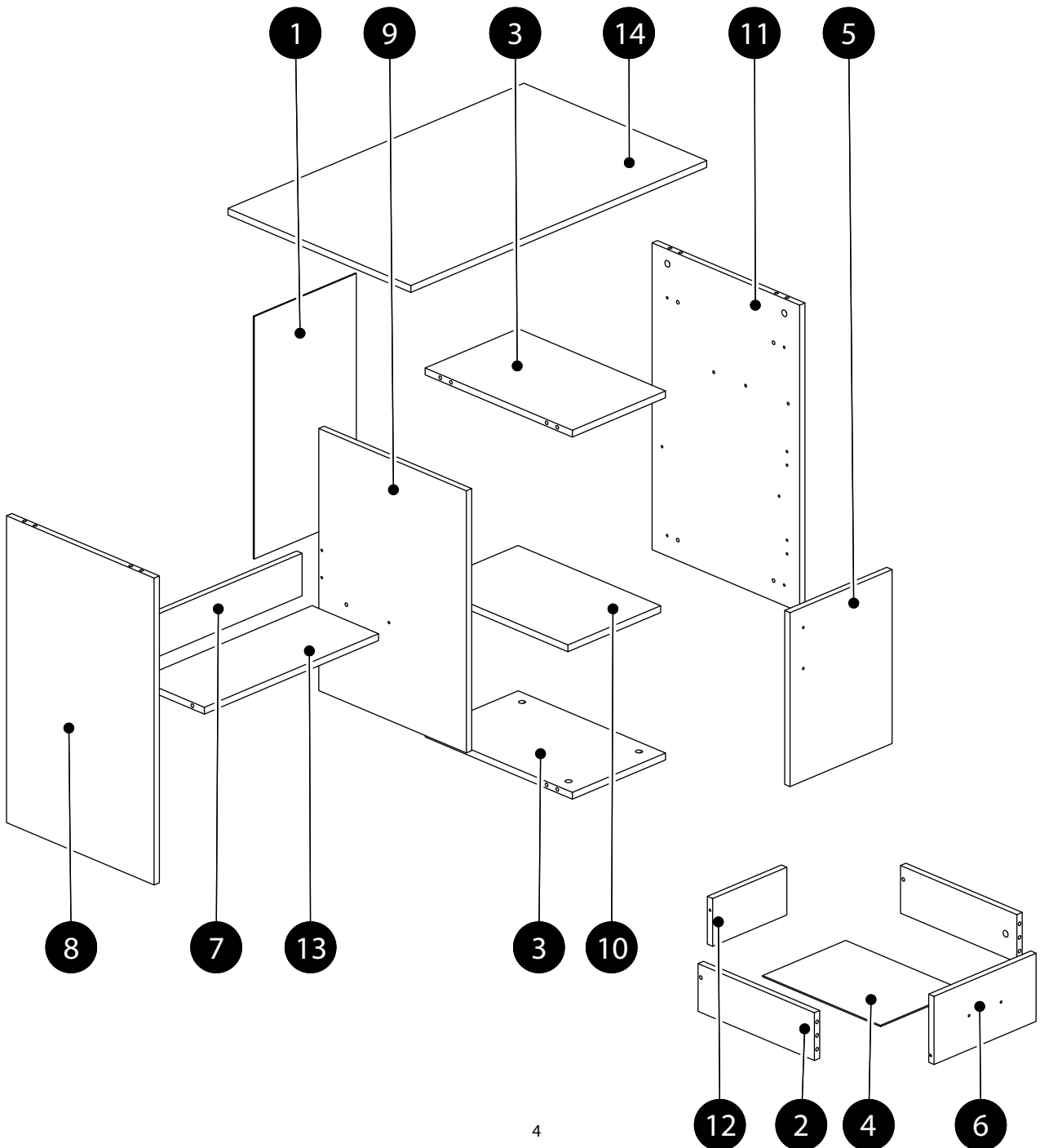

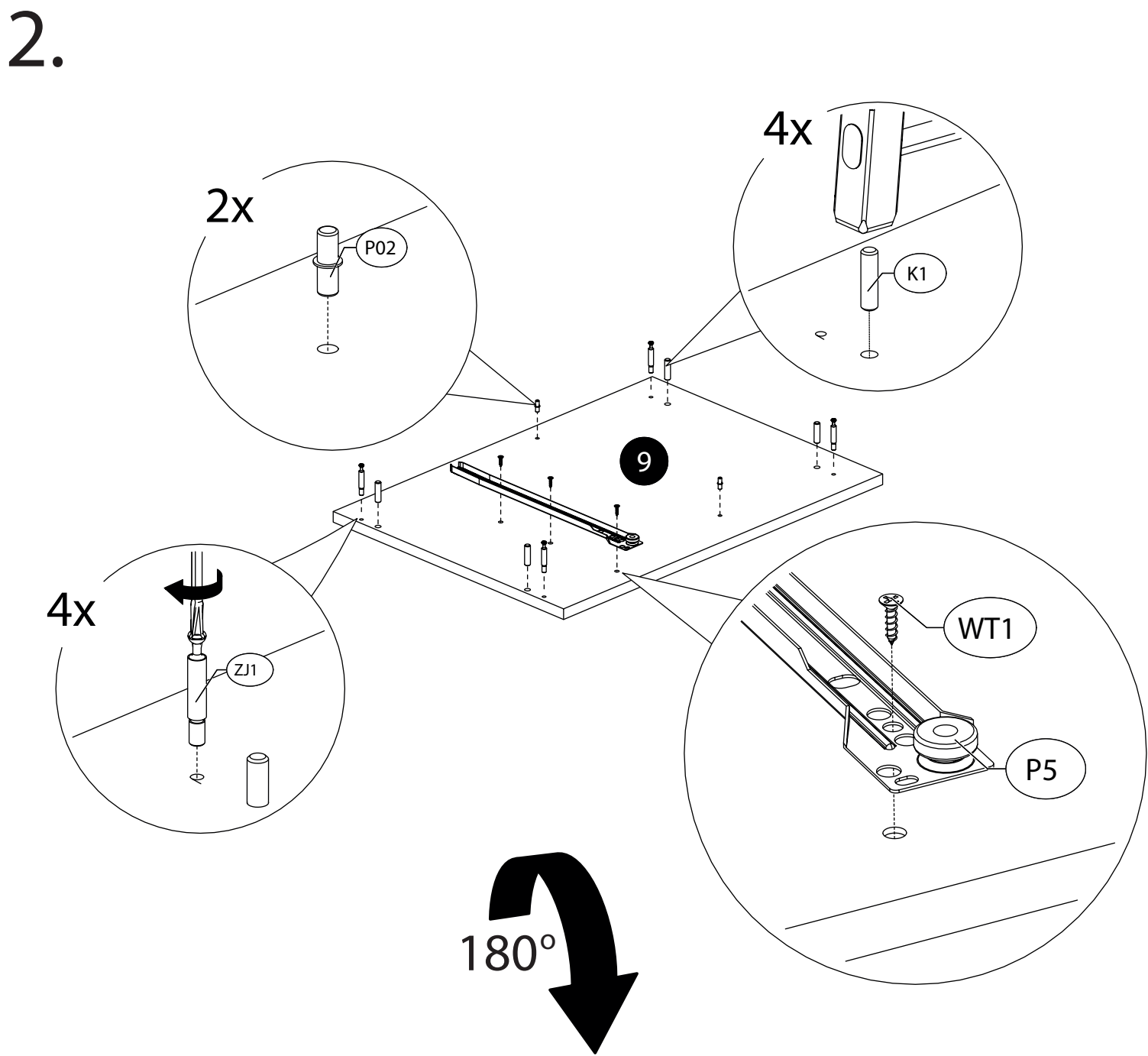
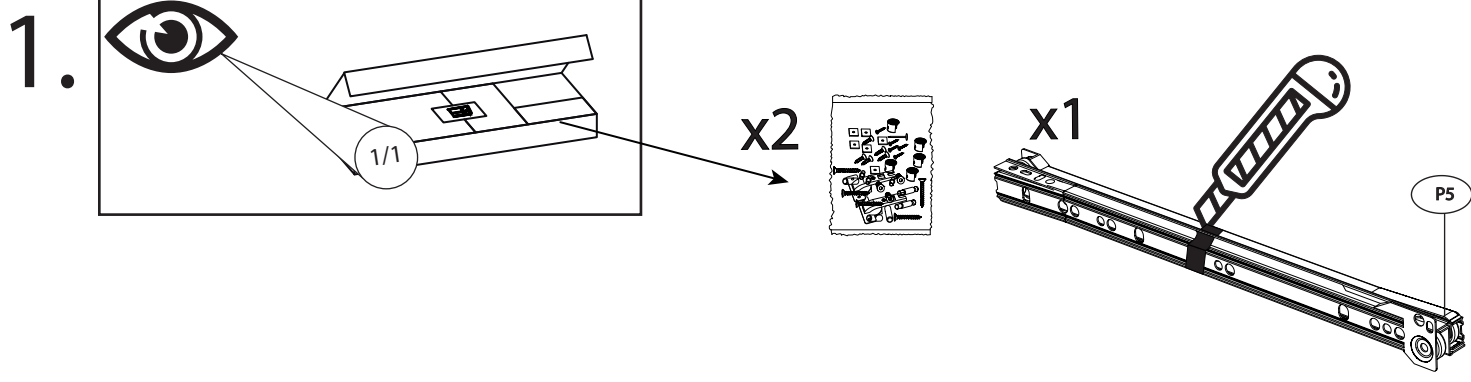

3.

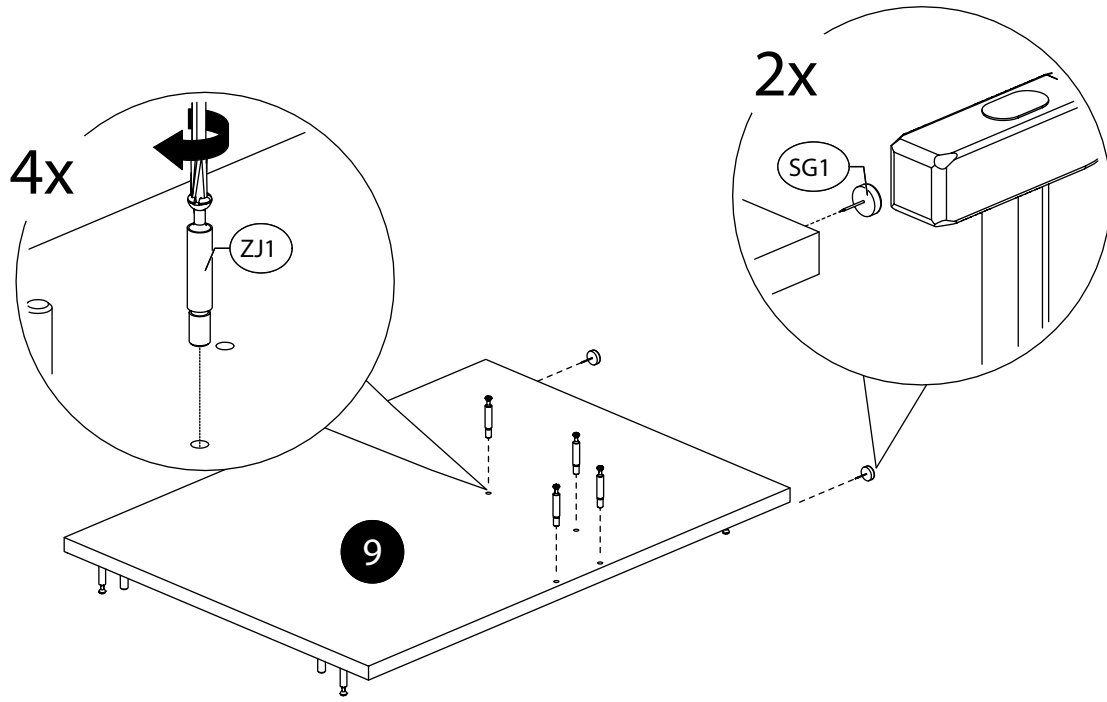

4.

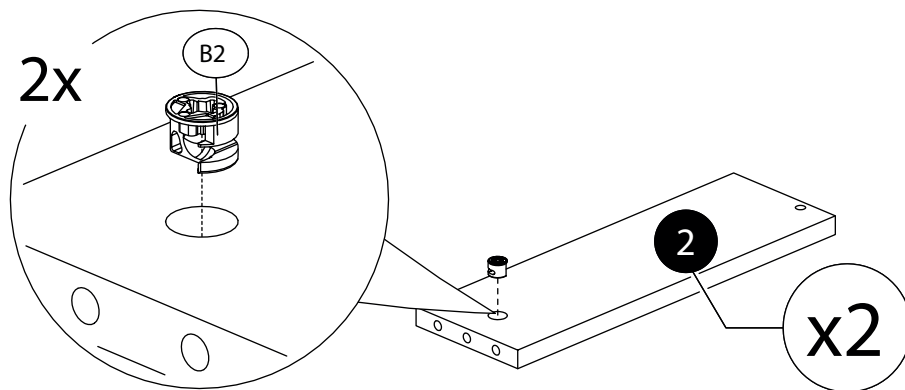

5.

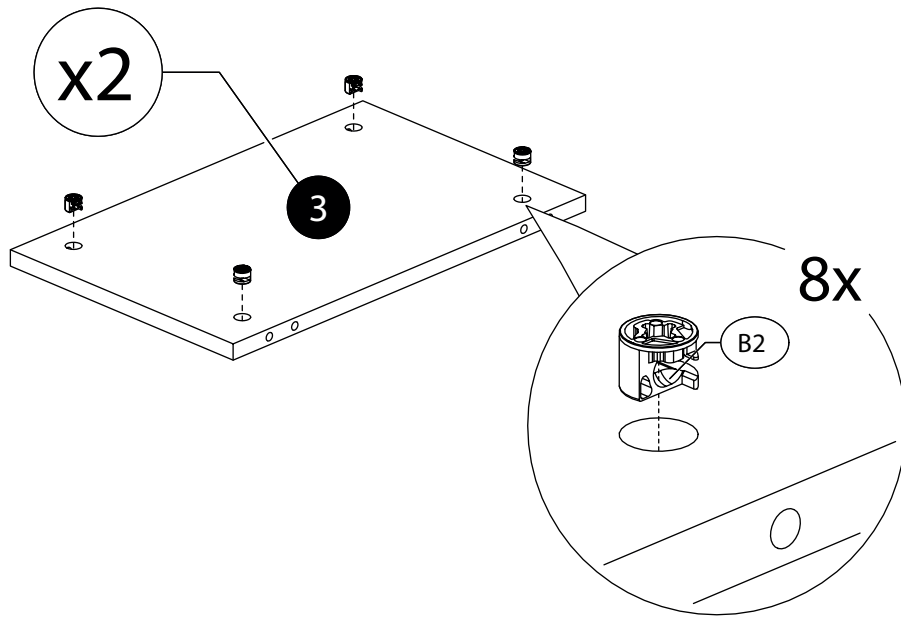

6.

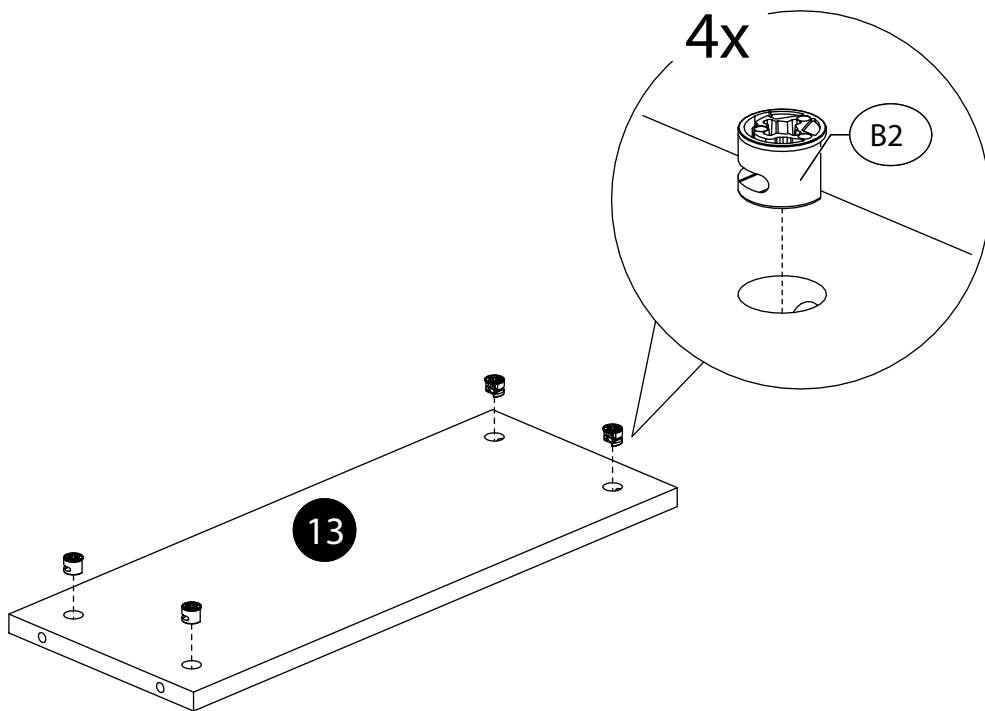

7.

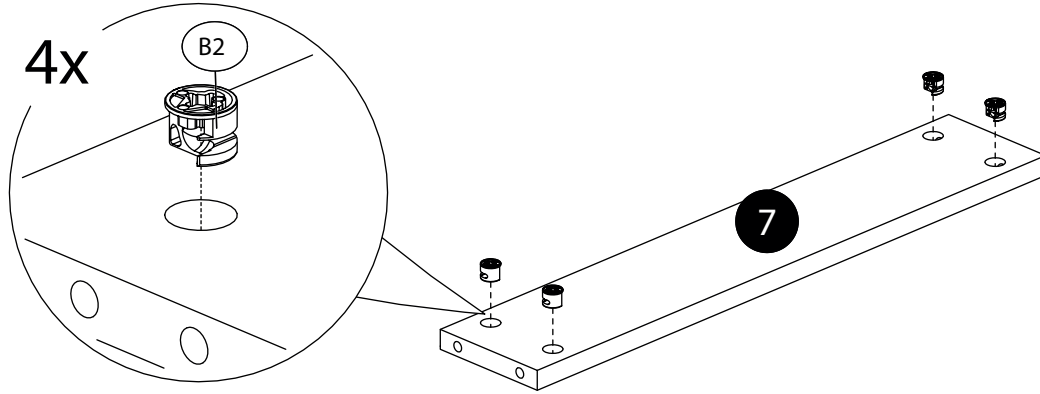

8.

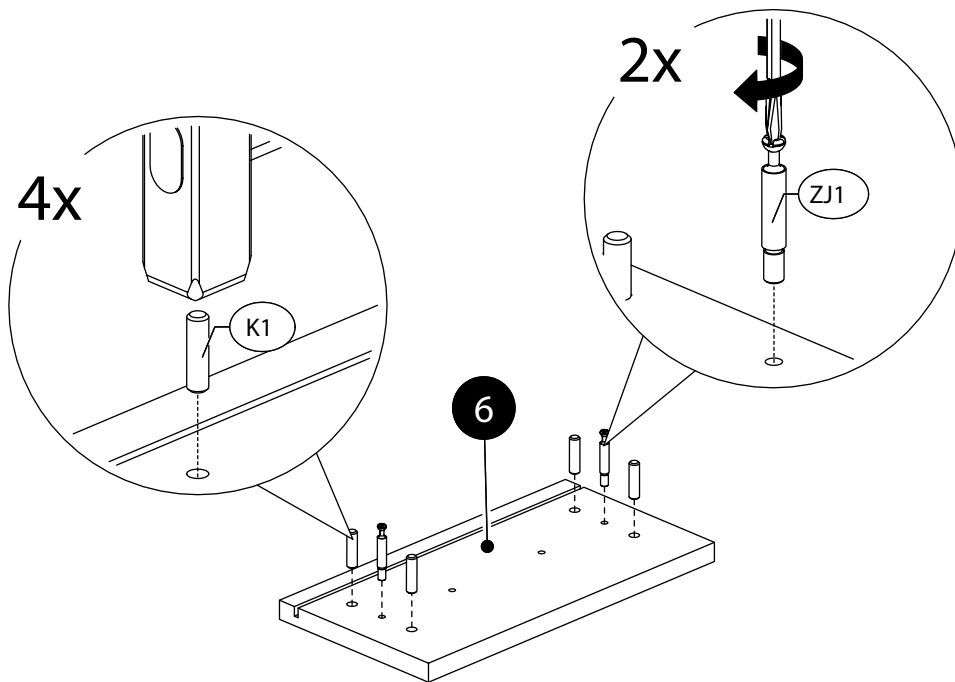

9.

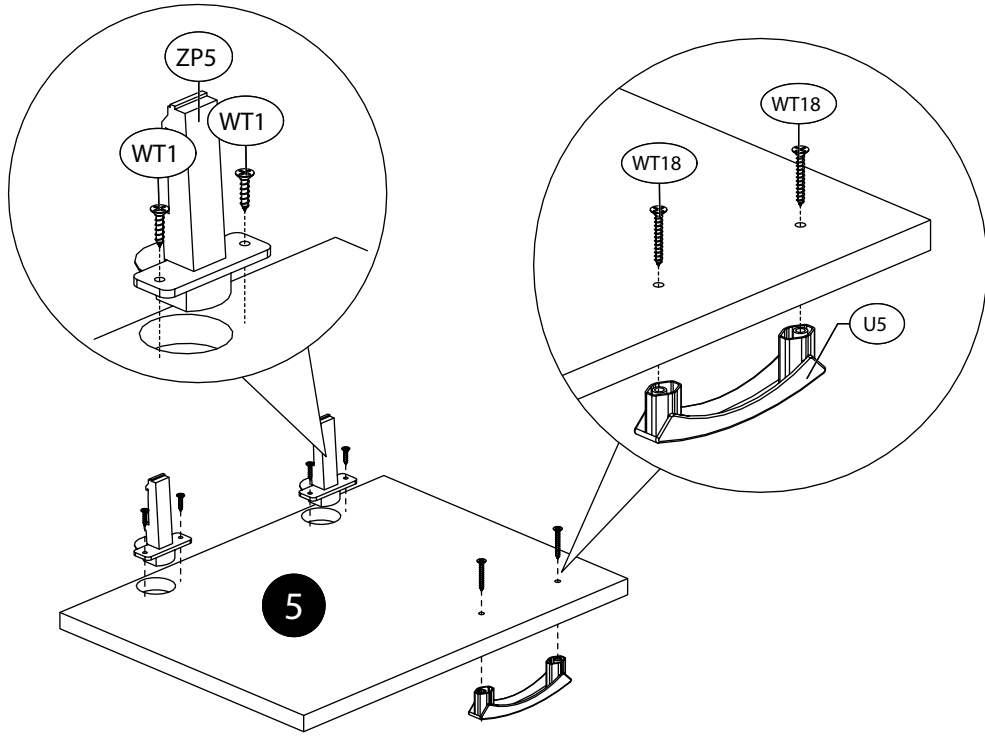

10.

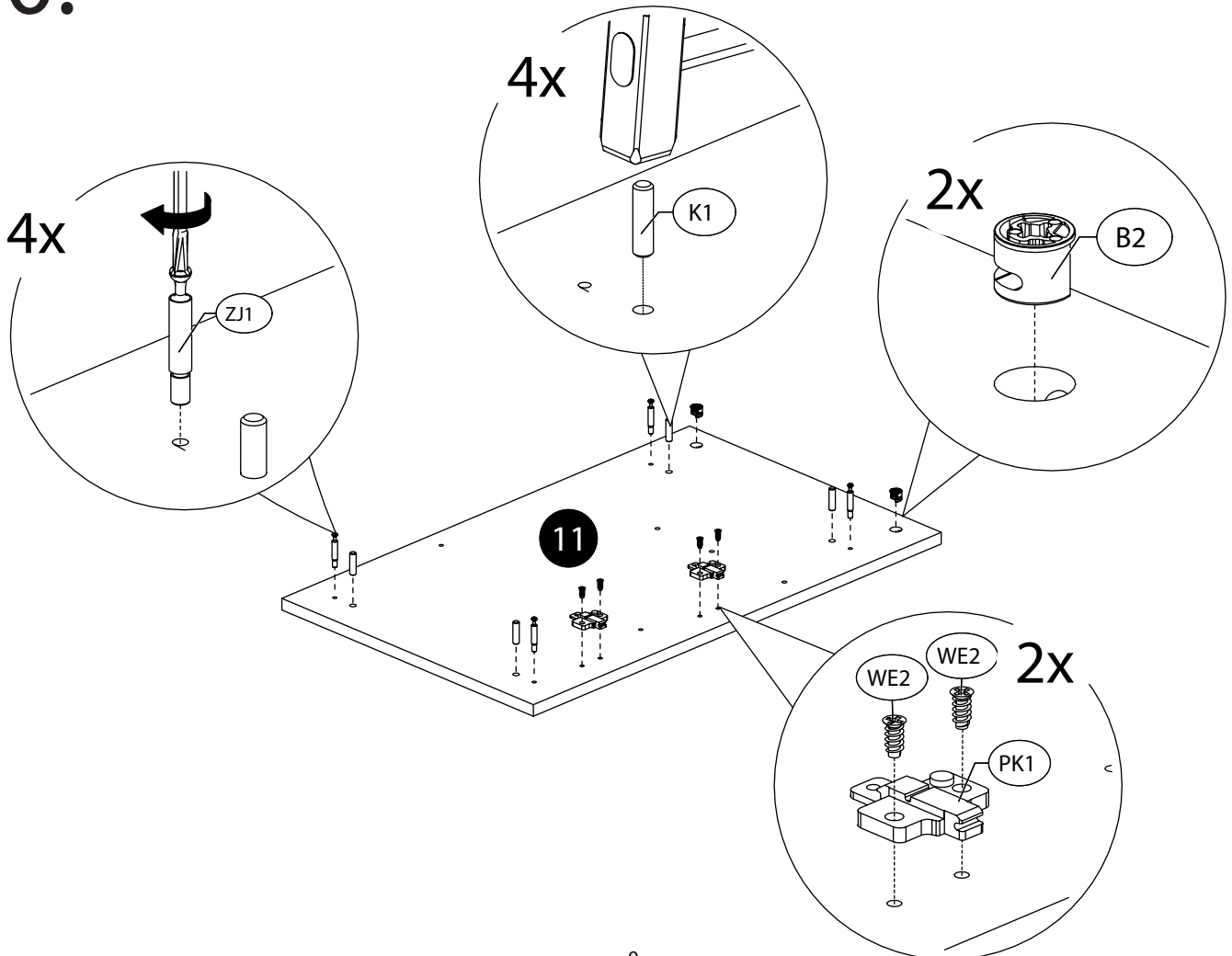

11.

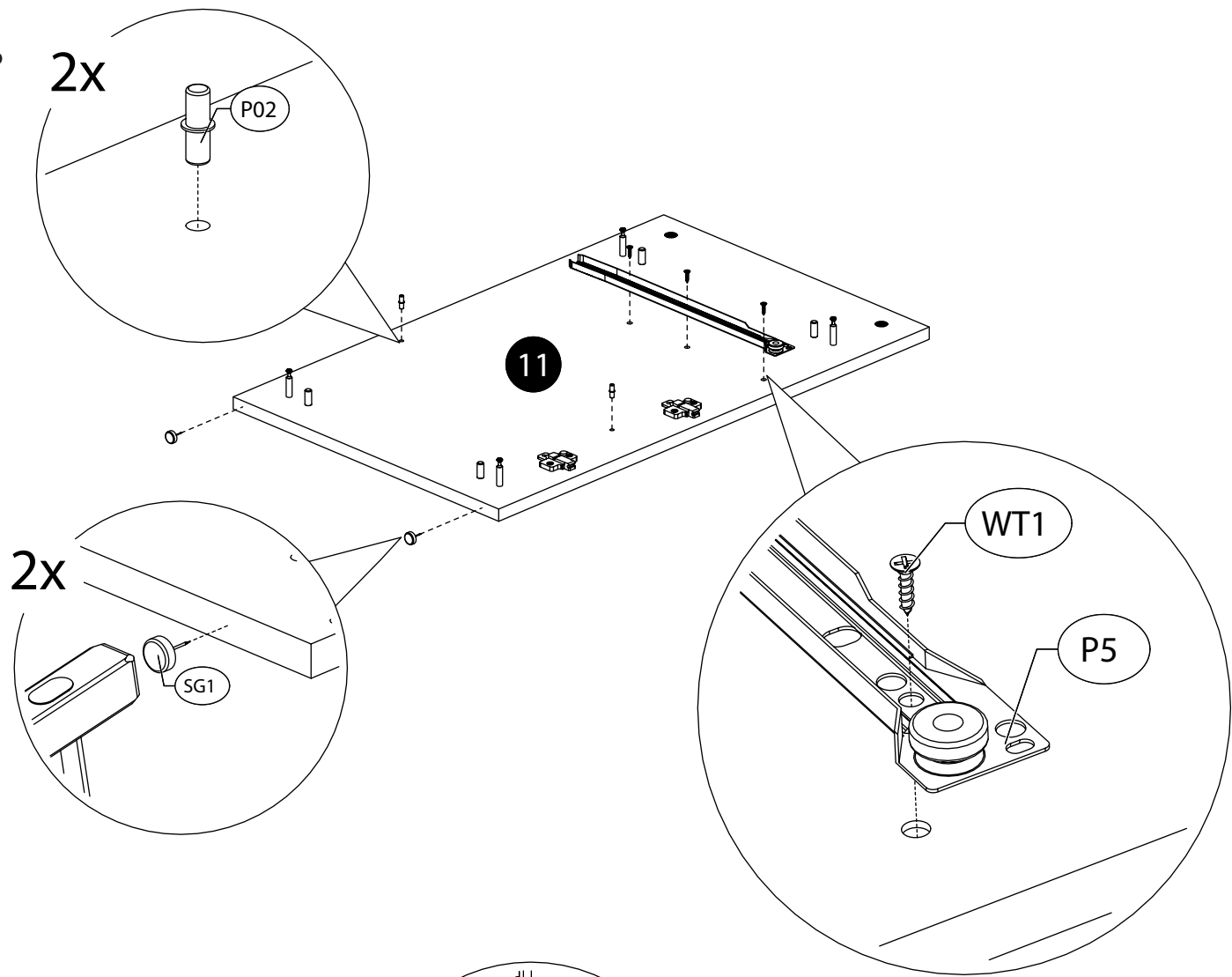

12.

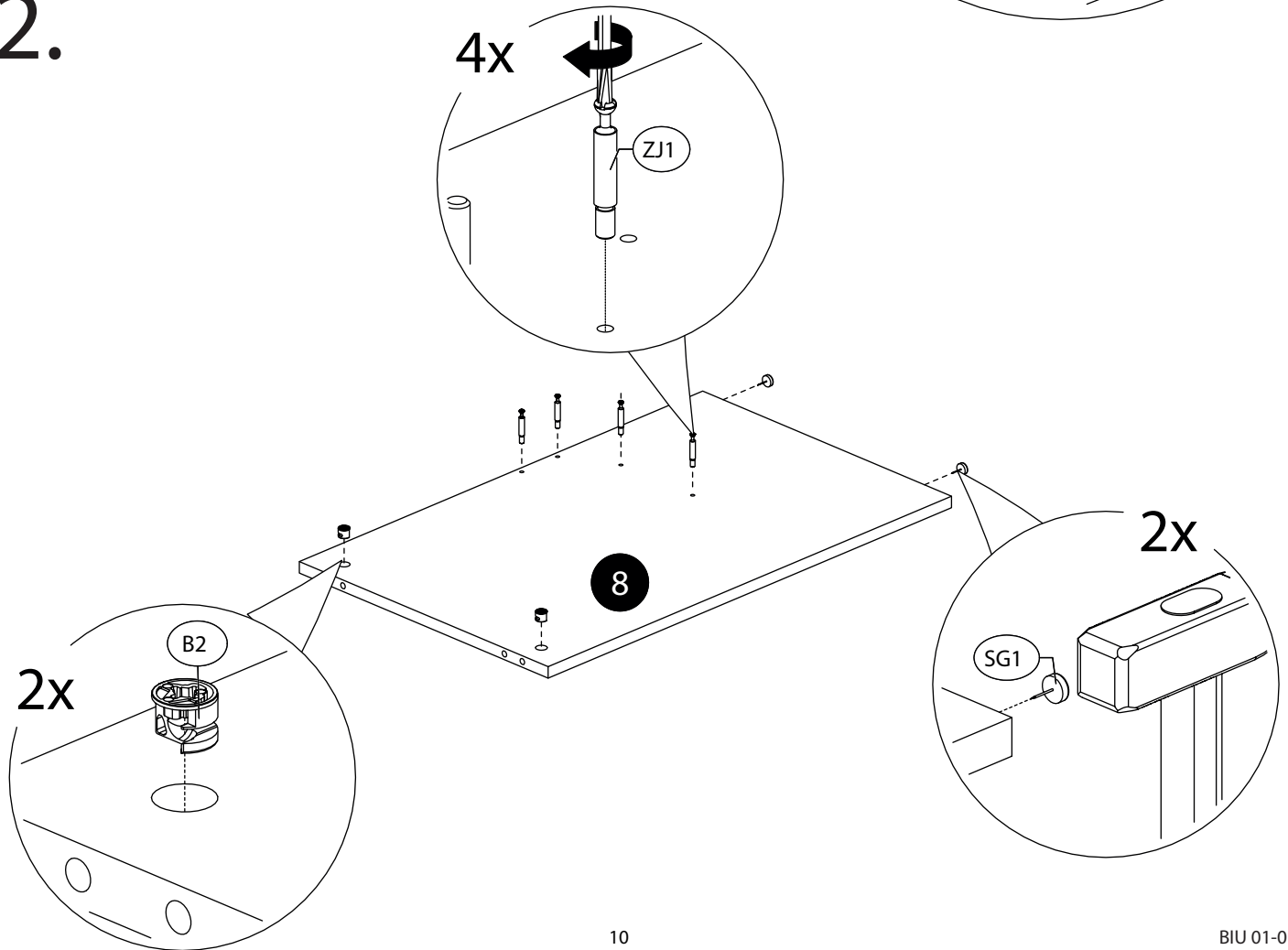

13.

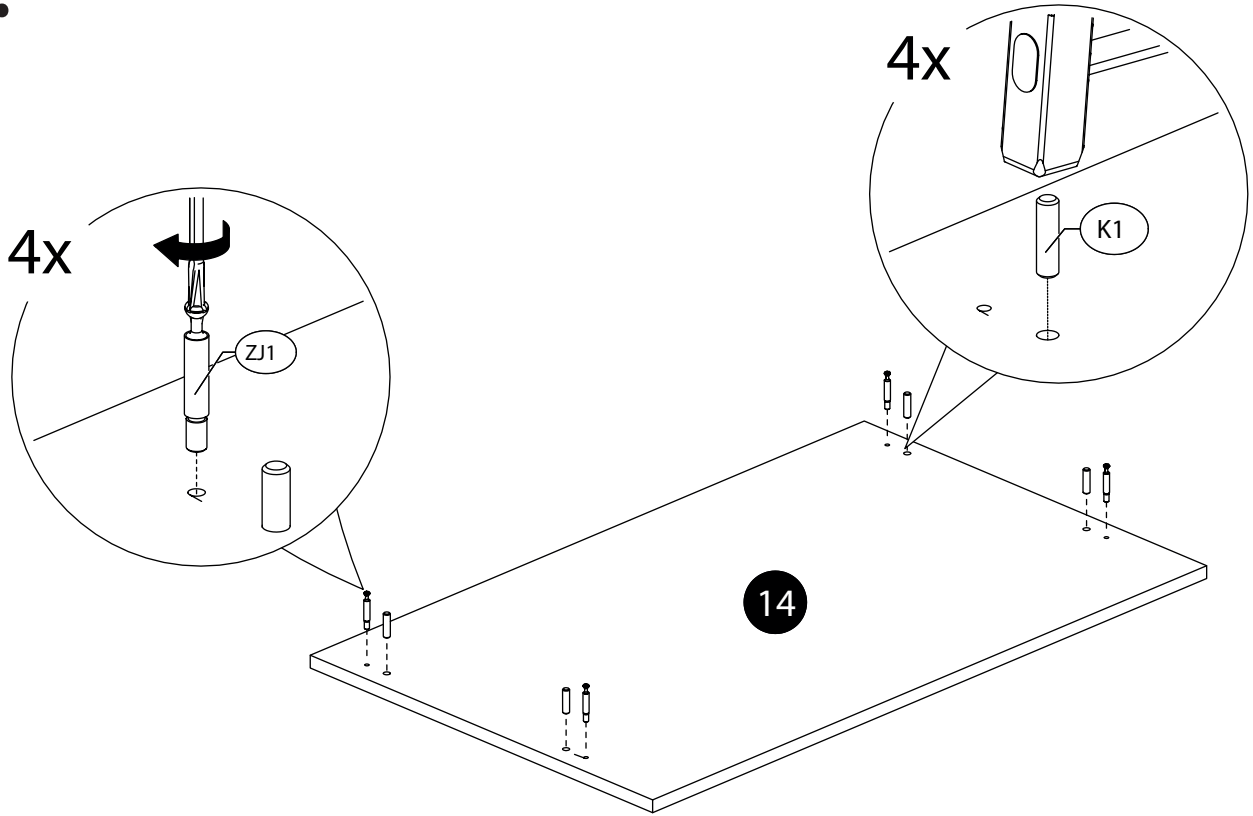

14.

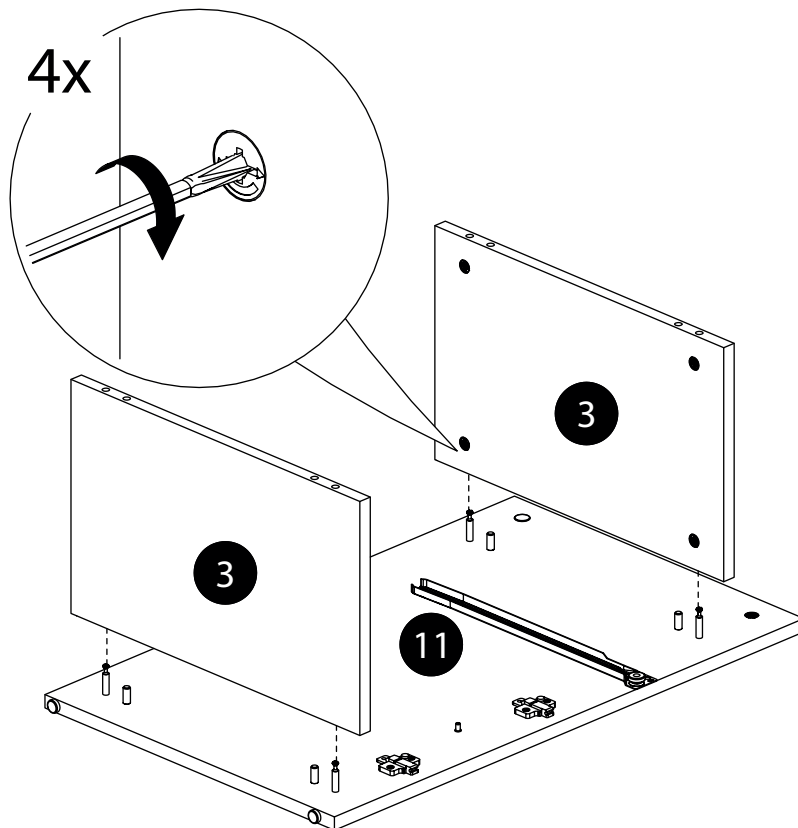

15.

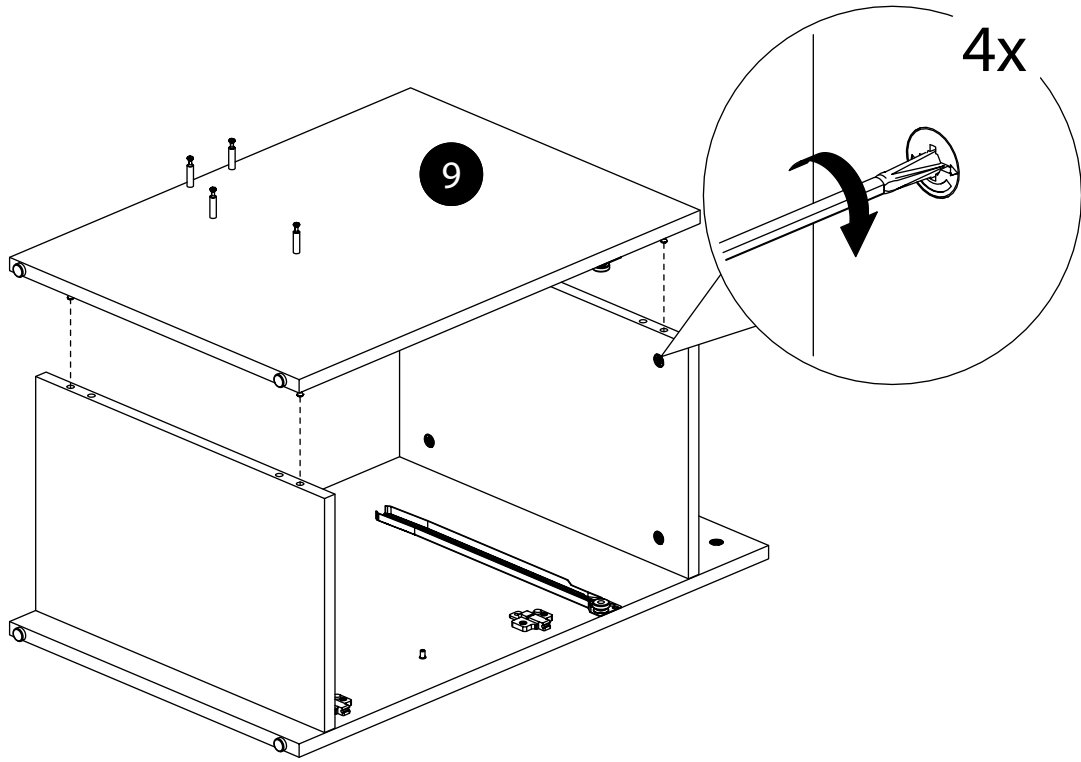

16.

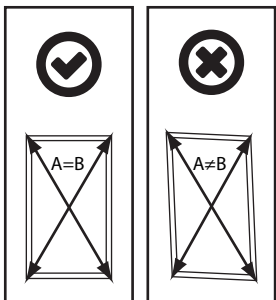
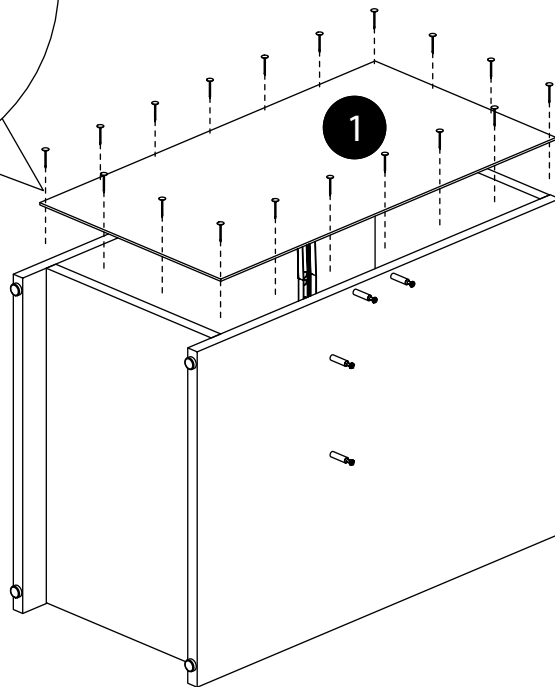
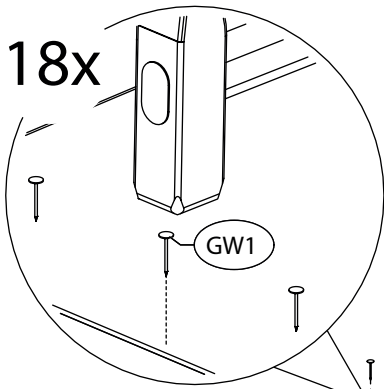
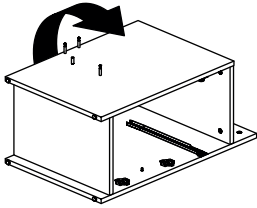

17.

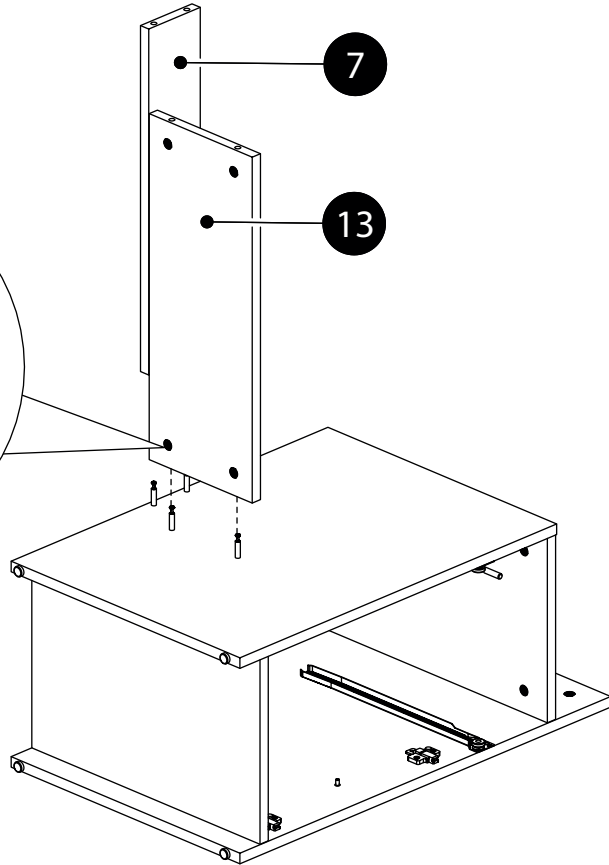
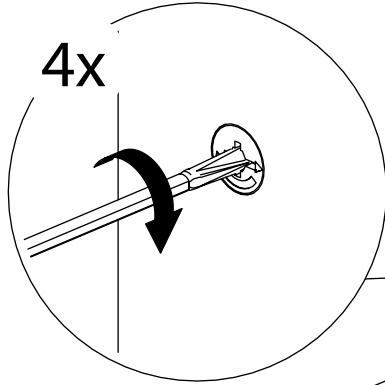
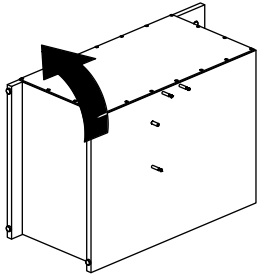

18.

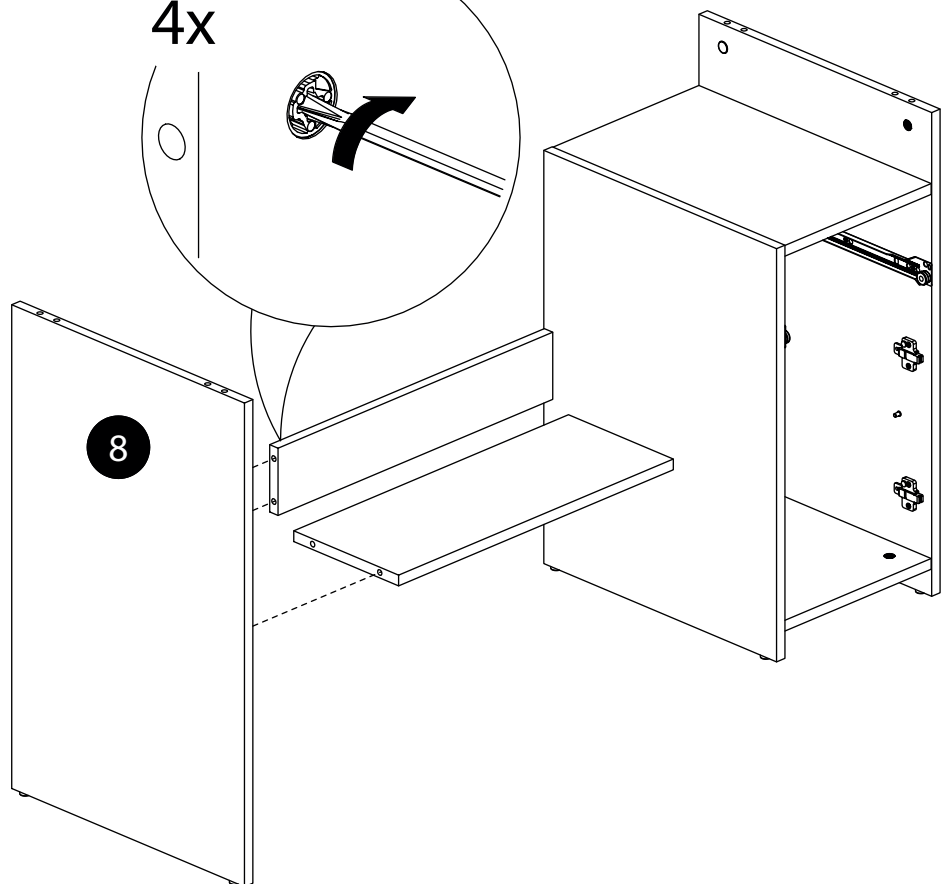
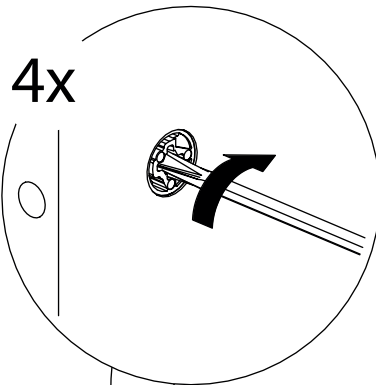
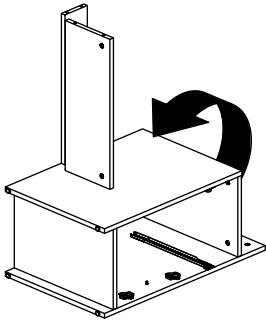

19.

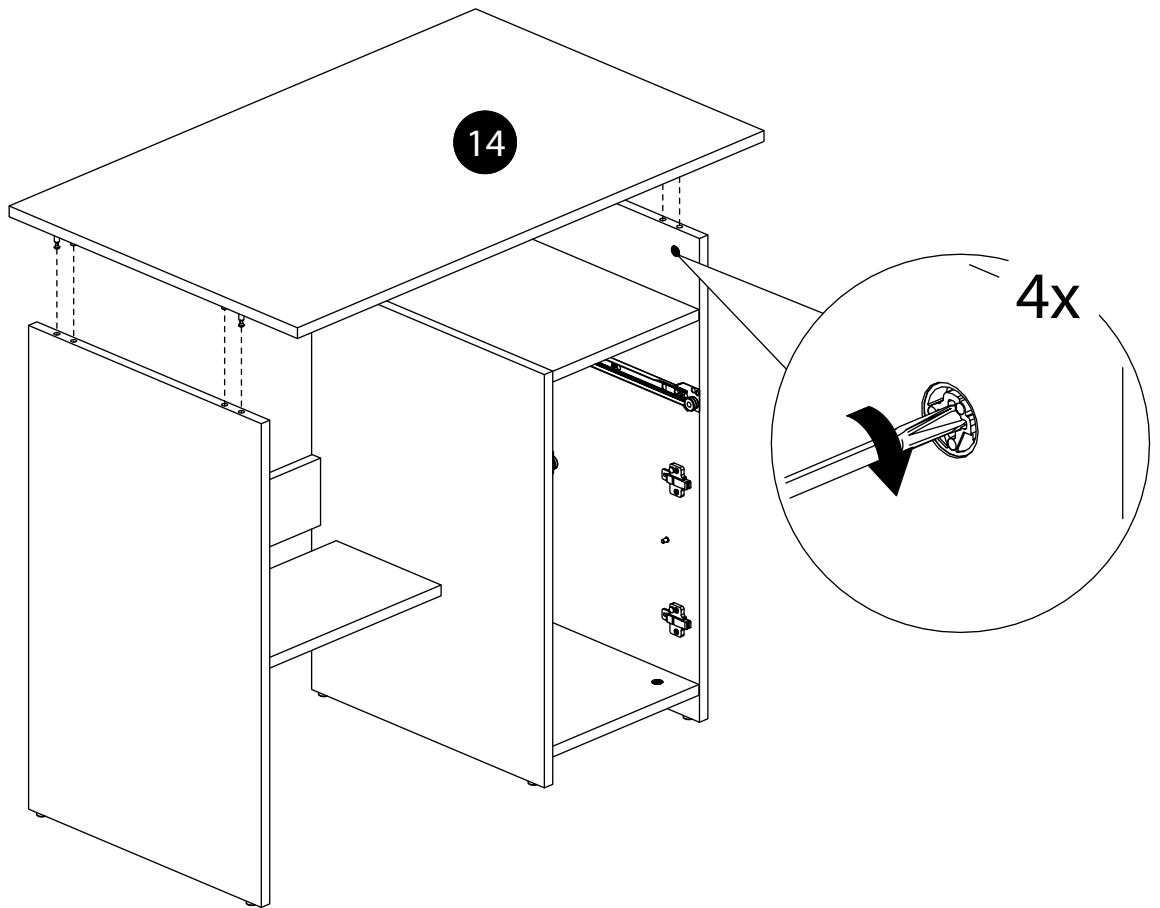

20.

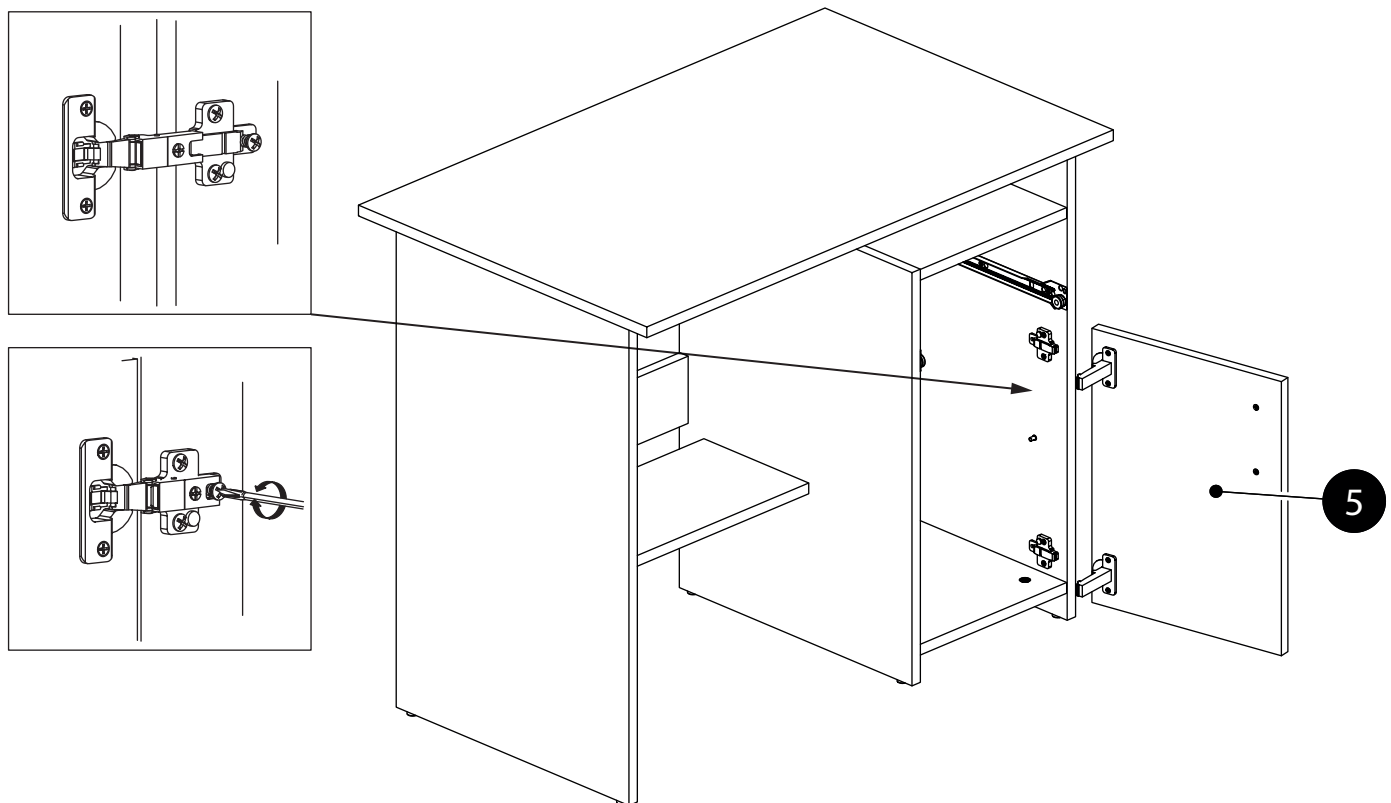

21.

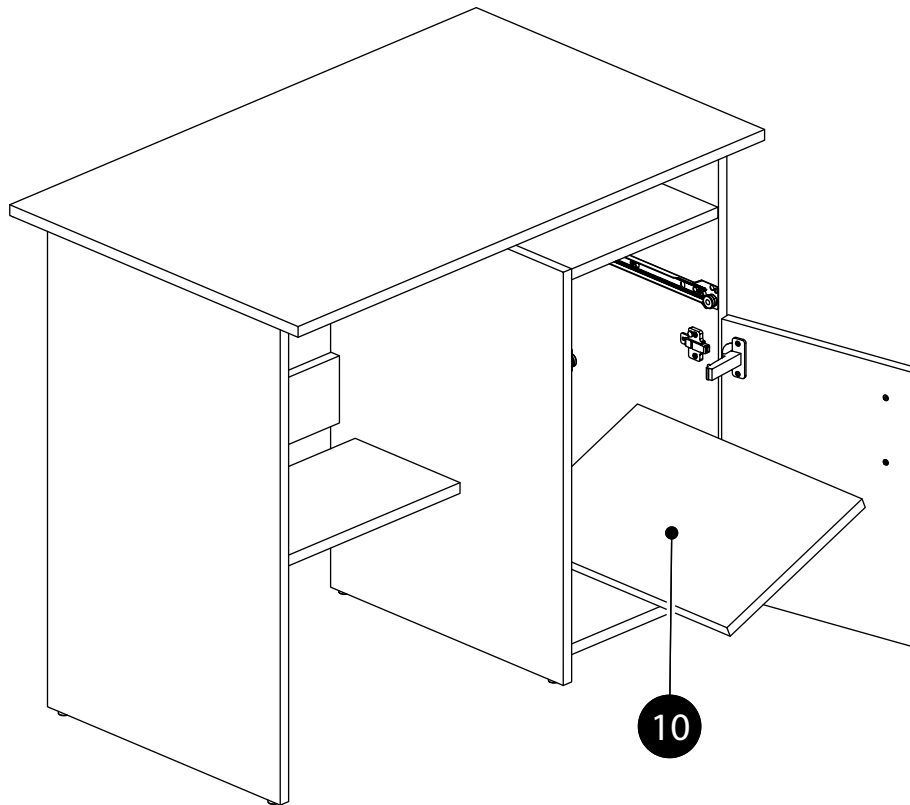

22.

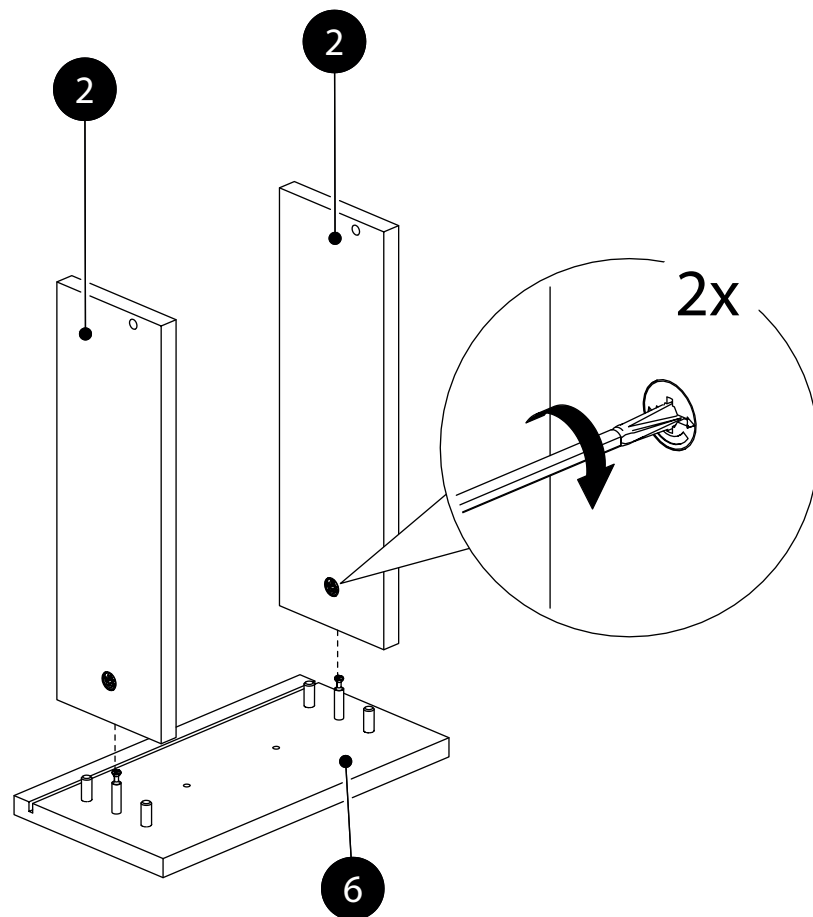

23.

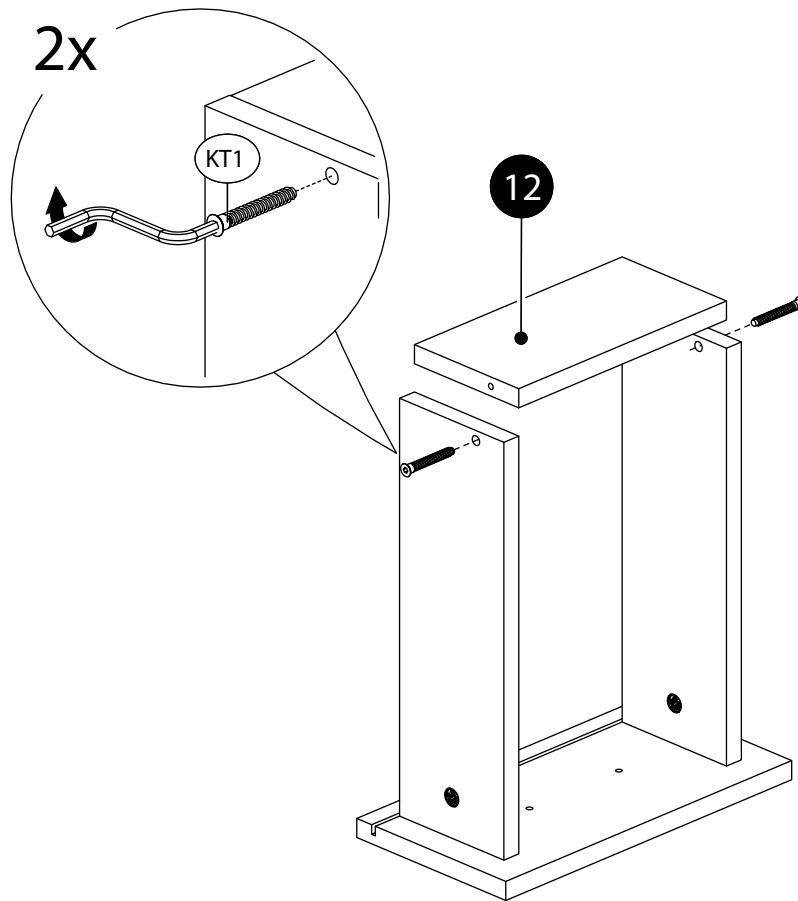

24.

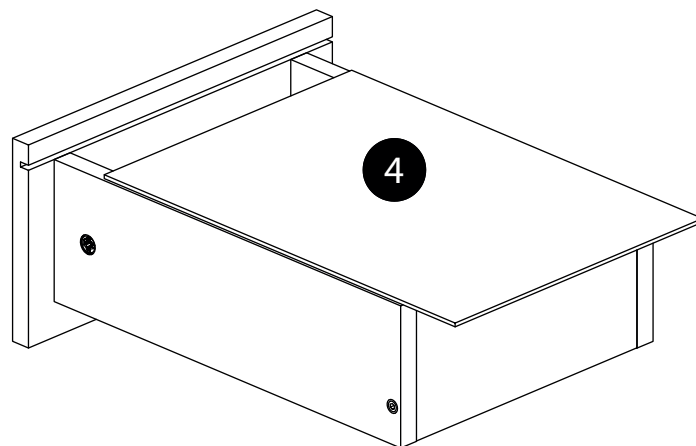
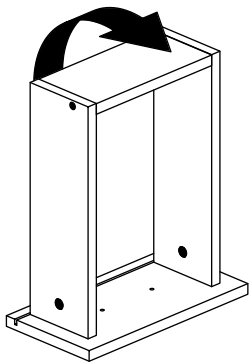

25.

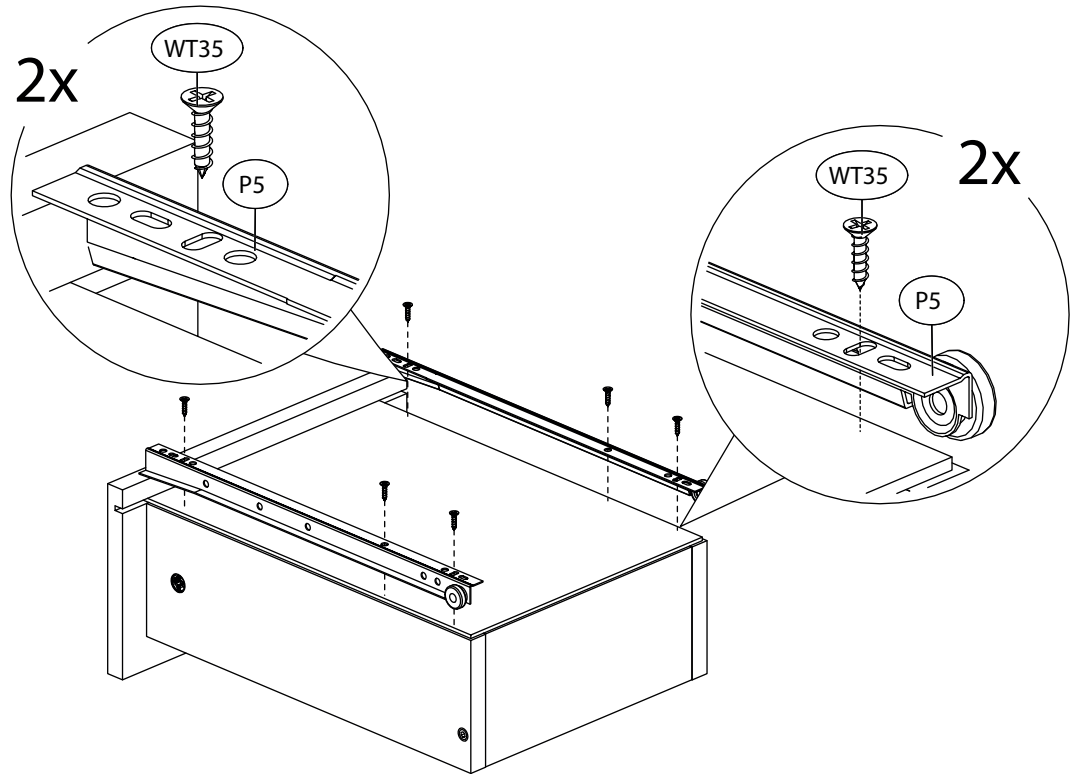

26.

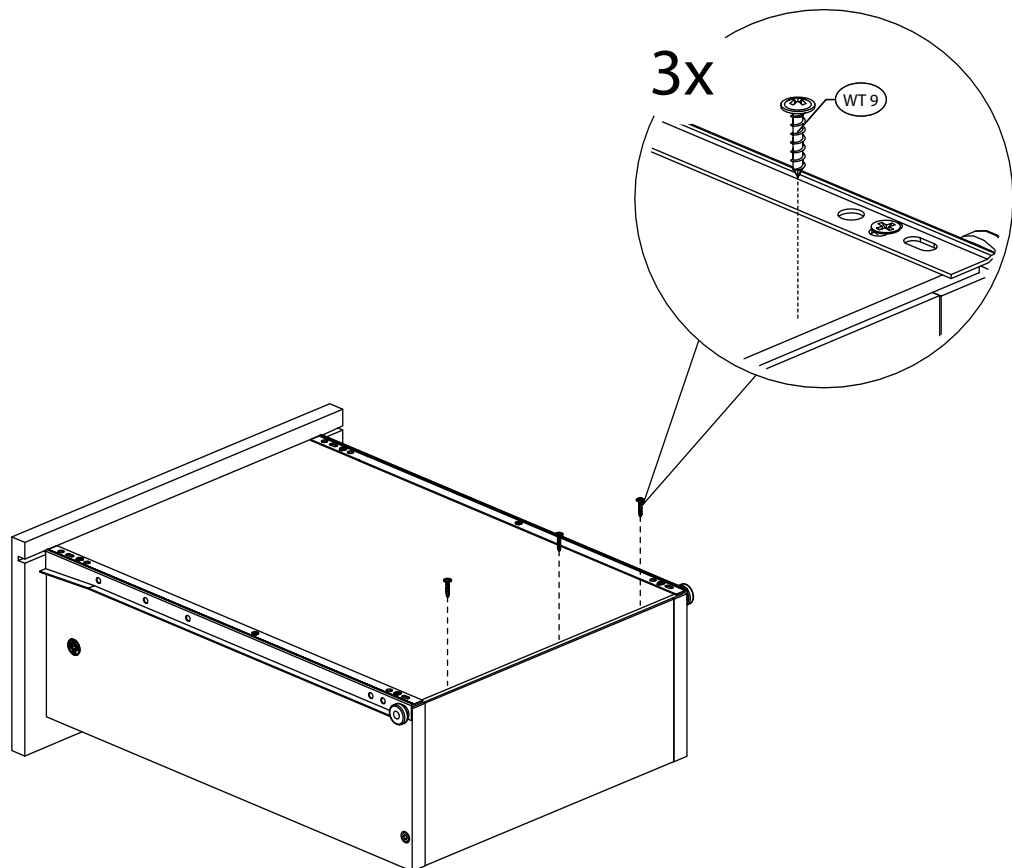

27.

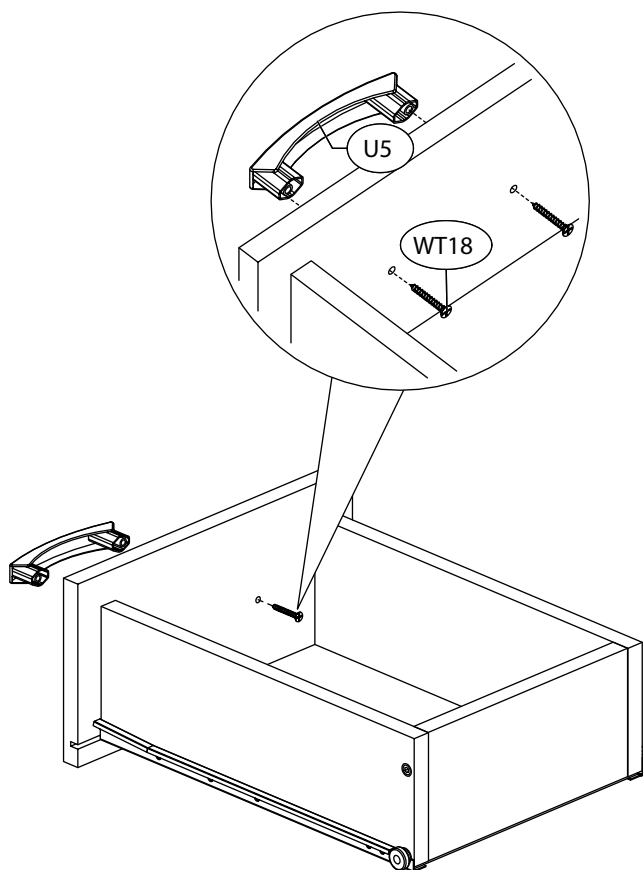
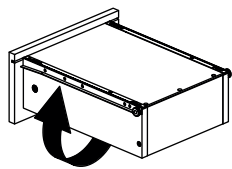

28.

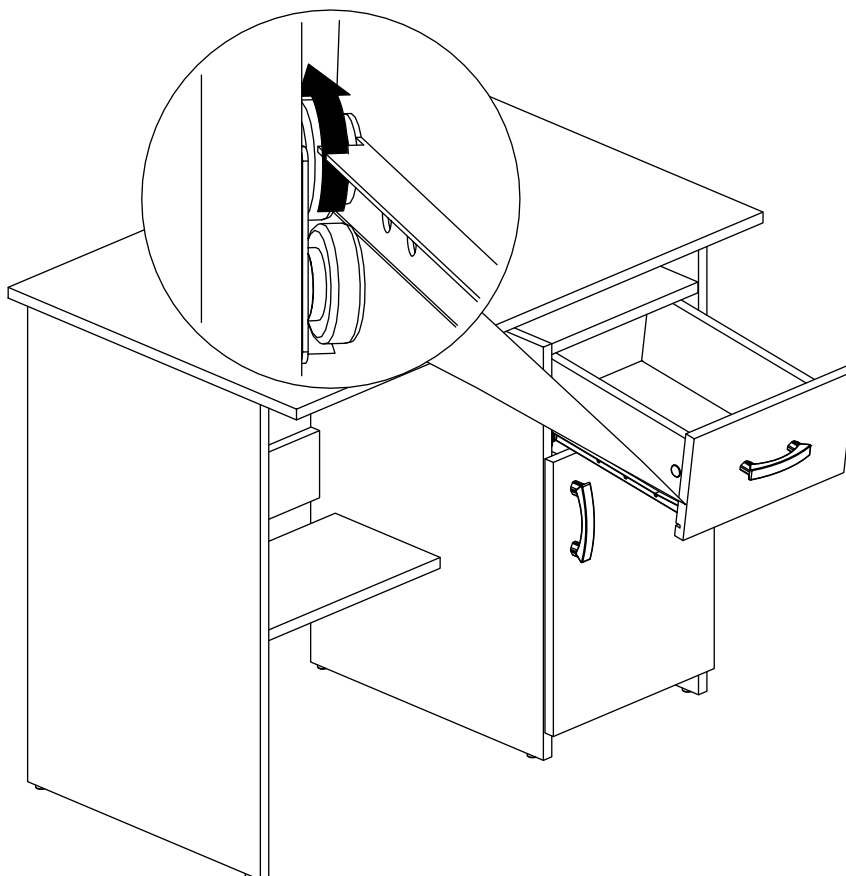

29.

