

|   | A       | B    | C   | D   | A  | B       | C    | D   |     |
|---|---------|------|-----|-----|----|---------|------|-----|-----|
| 1 | S85-001 | 896  | 446 | 4/4 | 10 | S85-303 | 497  | 337 | 2/4 |
| 2 | S85-002 | 446  | 446 | 4/4 | 11 | S85-304 | 334  | 351 | 2/4 |
| 3 | S85-003 | 446  | 267 | 4/4 | 12 | S85-307 | 498  | 351 | 2/4 |
| 4 | S85-101 | 1928 | 355 | 1/4 | 13 | S85-551 | 1962 | 80  | 3/4 |
| 5 | S85-103 | 1928 | 351 | 2/4 | 14 | S85-552 | 882  | 80  | 3/4 |
| 6 | S85-201 | 881  | 355 | 2/4 | 15 | S85-901 | 1948 | 515 | 1/4 |
| 7 | S85-202 | 881  | 355 | 2/4 | 16 | S85-902 | 1948 | 353 | 2/4 |
| 8 | S85-301 | 498  | 351 | 2/4 | 17 | qa70/2  | LED  |     | 2/4 |
| 9 | S85-302 | 334  | 351 | 2/4 |    |         |      |     |     |

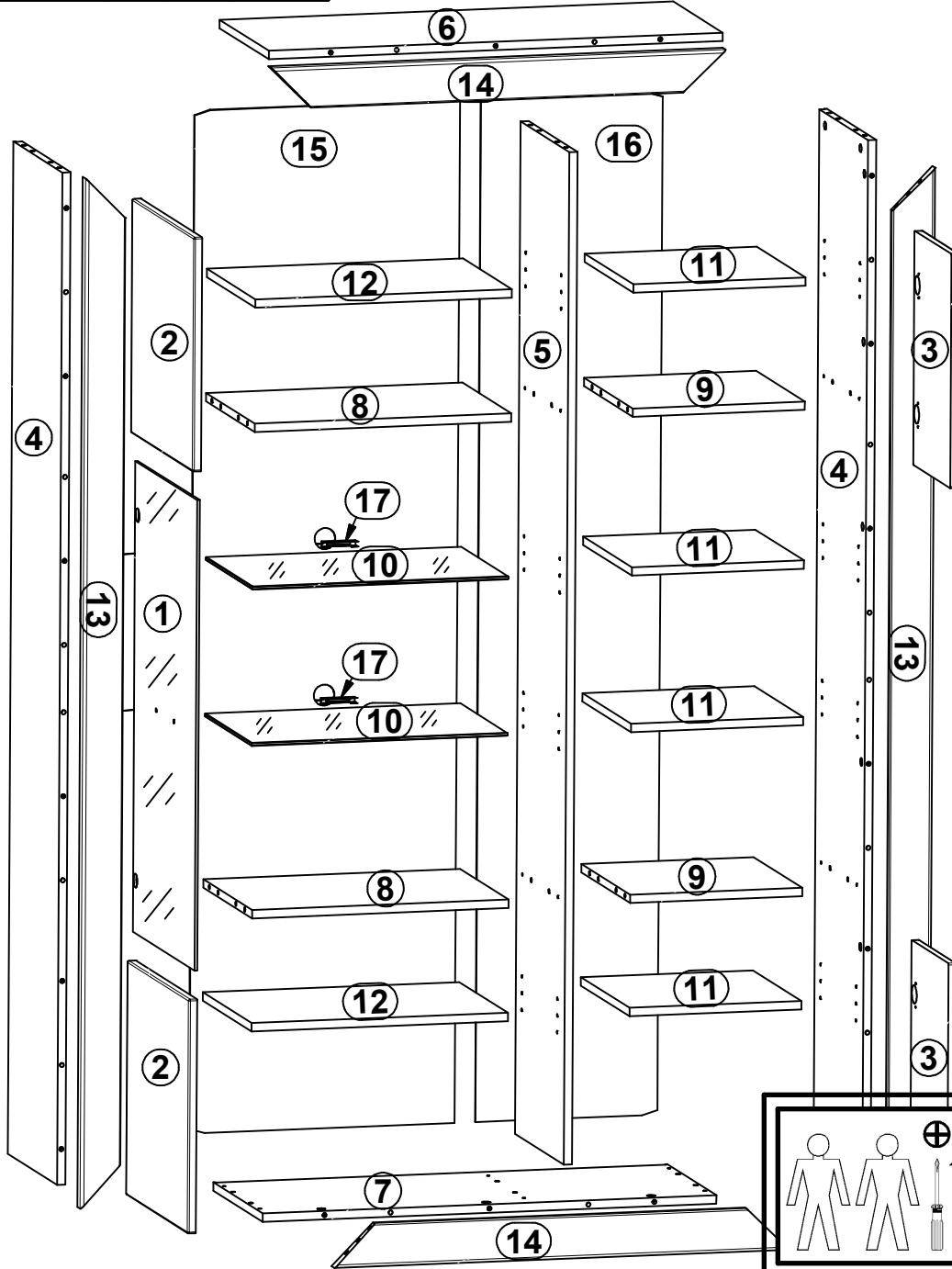

|                         |           |           |                          |                        |                     |                       |                     |                     |
|-------------------------|-----------|-----------|--------------------------|------------------------|---------------------|-----------------------|---------------------|---------------------|
| 8x  a56                 | 2x  a66/1 | 2x  a66/4 | 2x  a66/5                | 8x  b6                 | 2x  b27             | 3x  c197<br>128 mm    | 24x  d1<br>φ5x17 mm | 8x  d3<br>φ5x17 mm  |
| 52x  f1<br>φ8x30 mm     | 4x  k55   | 120x  l1  | 2x  o27<br>φ6,5φ10x5,2mm | 16x  p51<br>φ3,5x15 mm | 2x  p59<br>φ4x12 mm | 8x  p6<br>φ4x35 mm    | 4x  p9<br>φ4x30 mm  | 4x  p92<br>φ3x11 mm |
| 54x  r1<br>φ15x12mm #16 | 4x  r10   | 46x  r16  | 44x  s2<br>φ16           | 2x  s53                | 1x  n26/1           | 1x  p38<br>φ3,5x16 mm |                     |                     |

1 

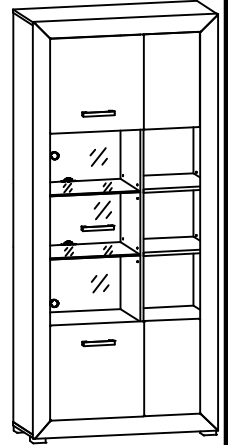
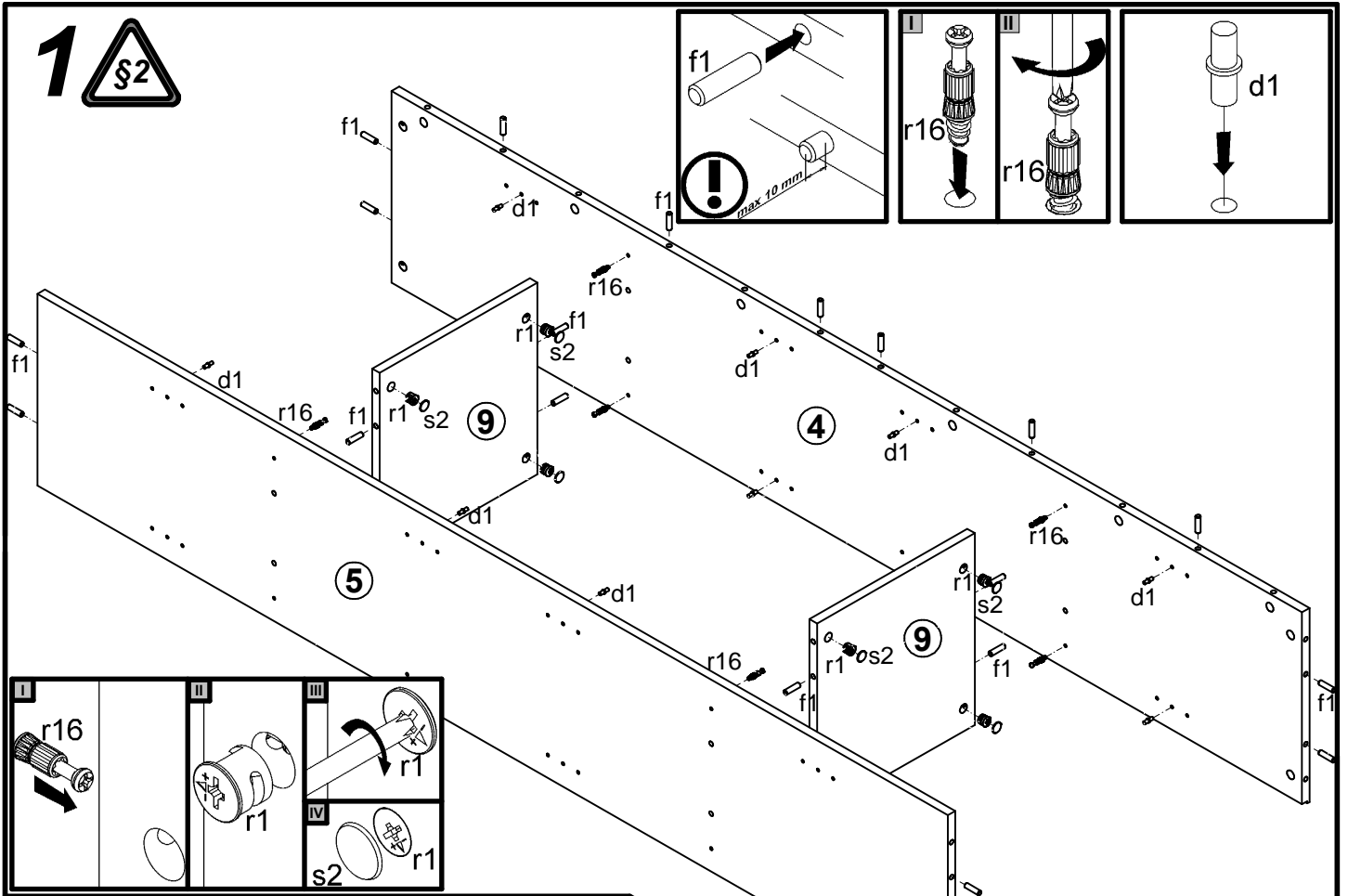

2 

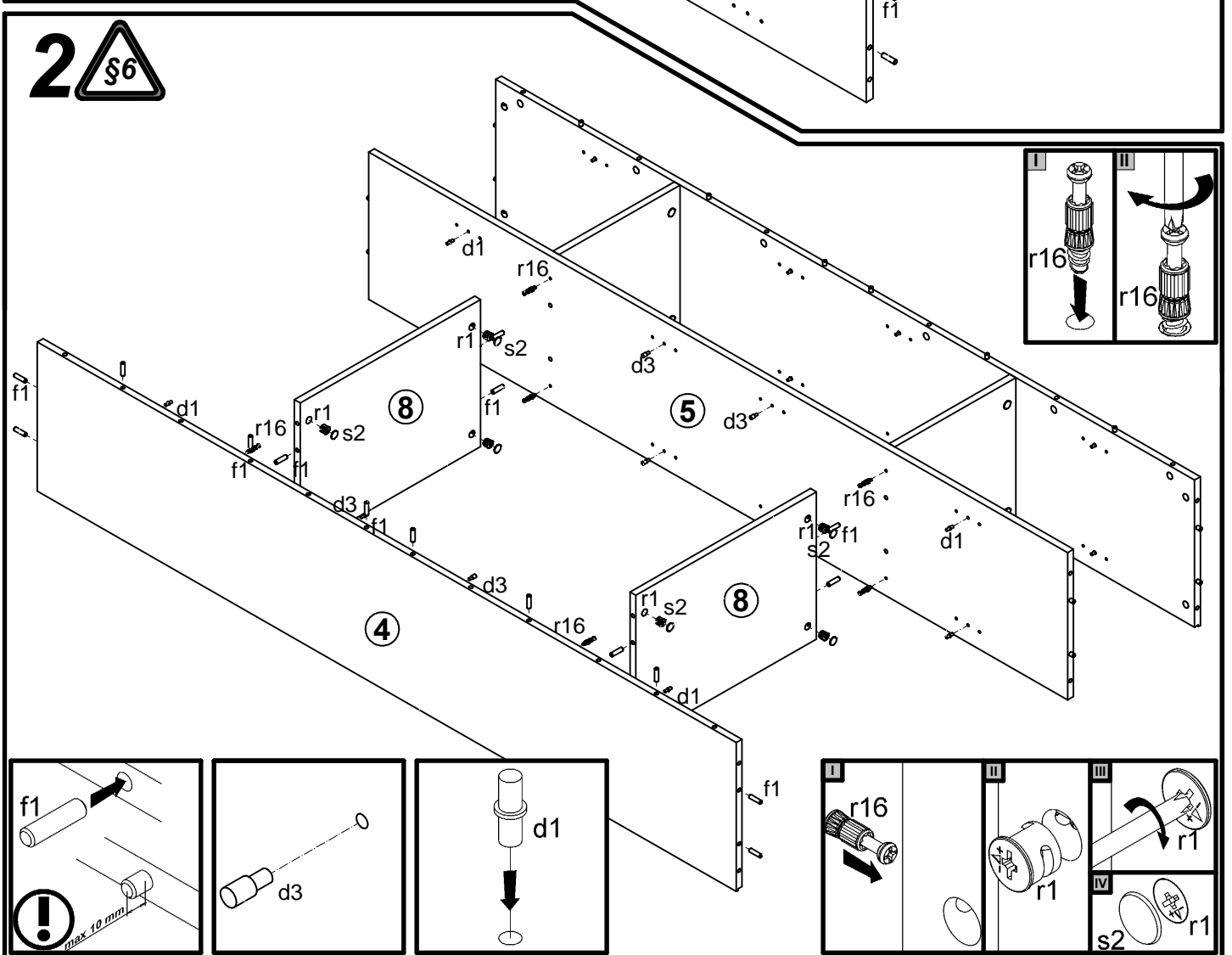

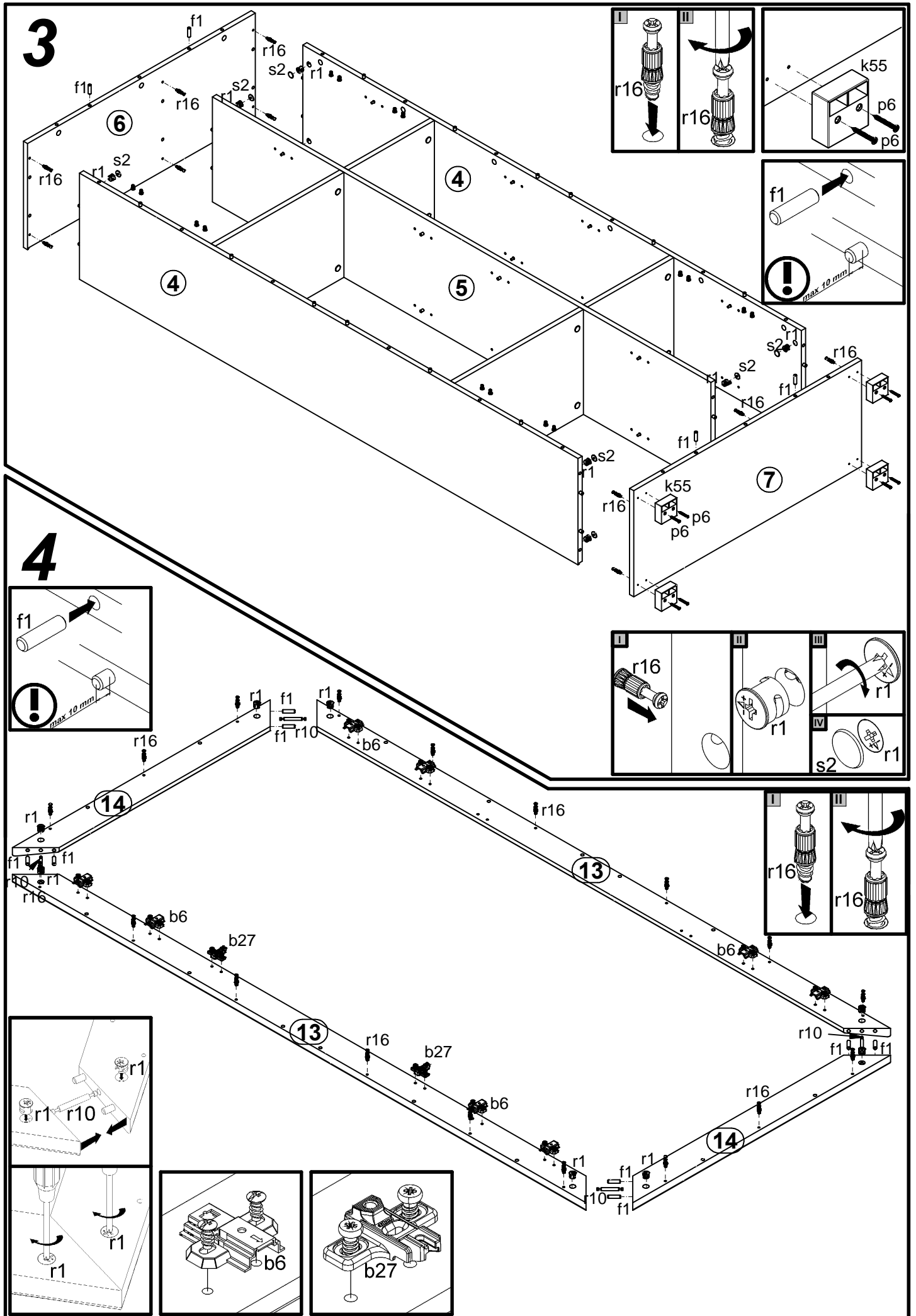

# 5

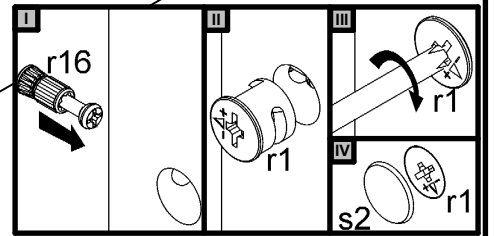
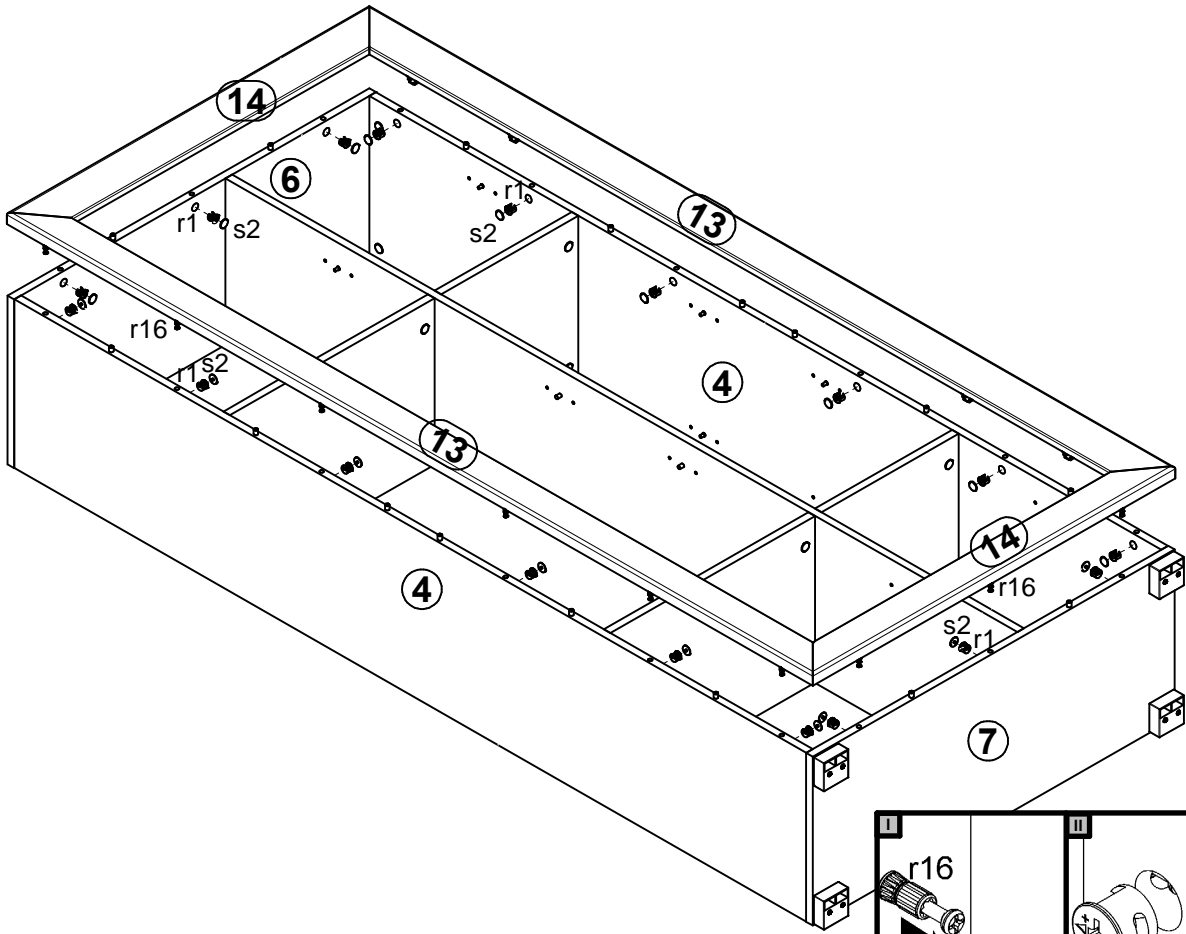

# 6

