

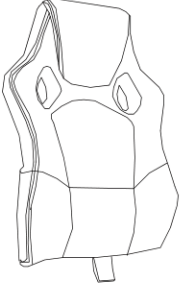

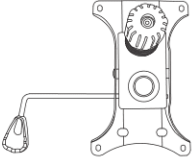





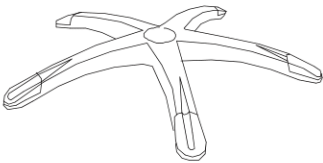

NÁVOD NA MONTÁŽ KA-Y157

 A x 1	 G x 1	 M6 105 x 1
 B x 1	 H x 1	 106 x 2
 C x 1	 101 x 4	 107 x 2
 D x 1	 102 x 4	
 E x 5	 103 x 4	
 F x 2	 104 x 8	
		$\varnothing 6 \times \varnothing 18$

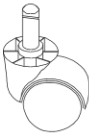
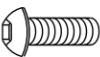
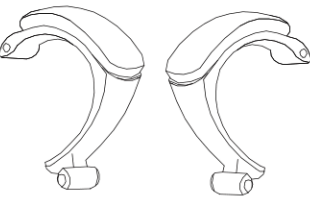

05

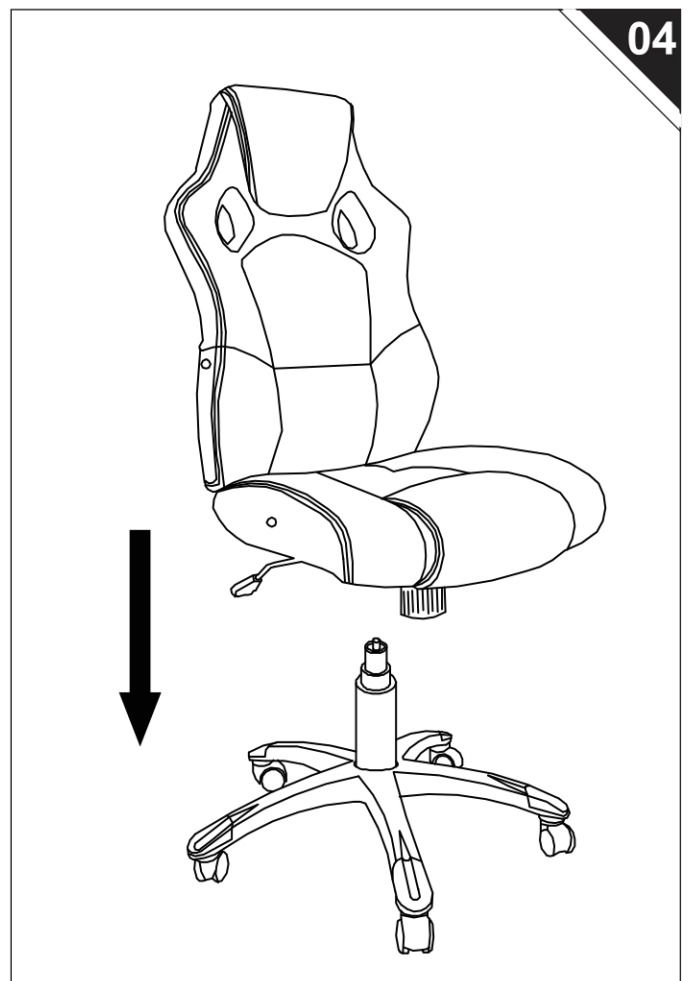
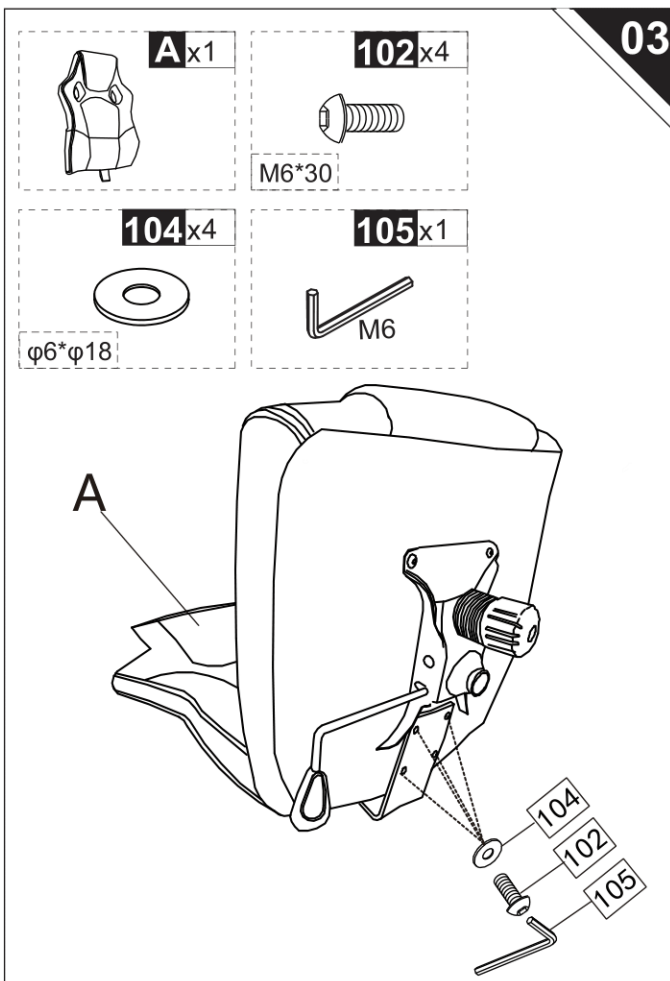
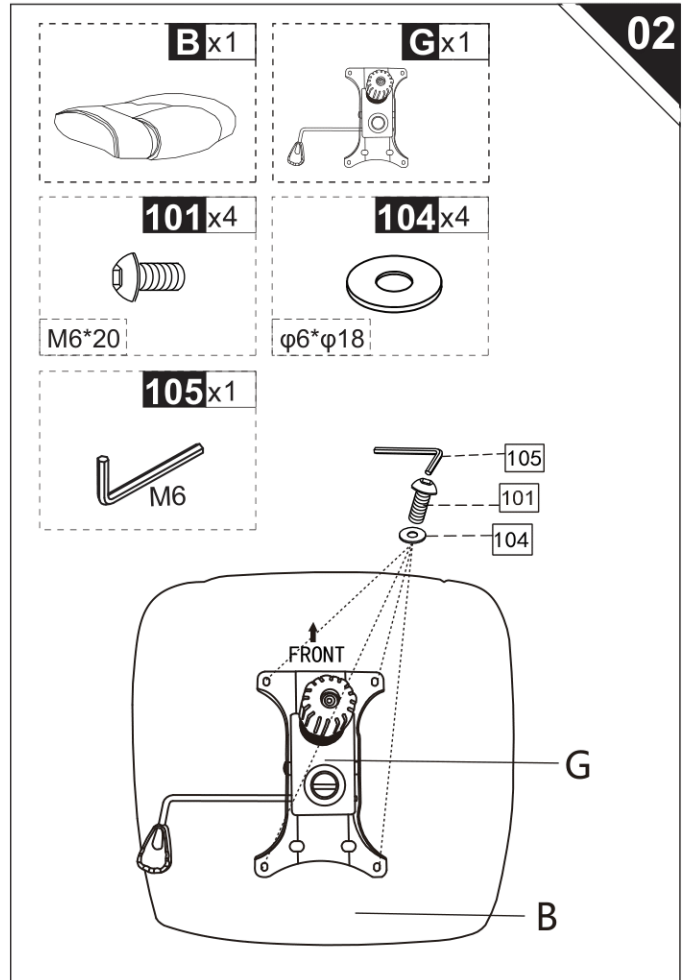
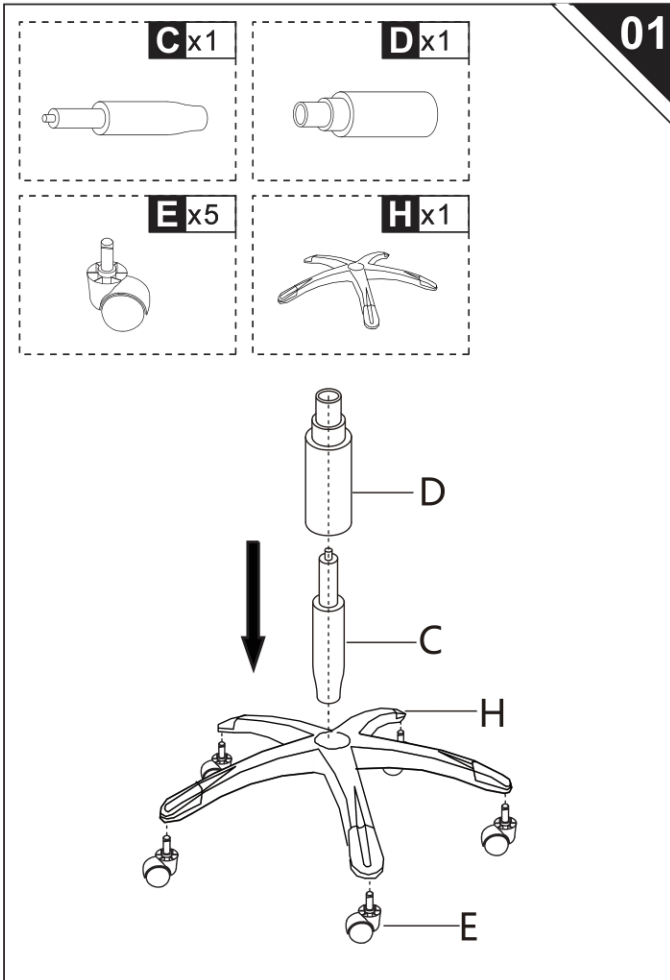
F x2



103 x4



M8*45

105 x1

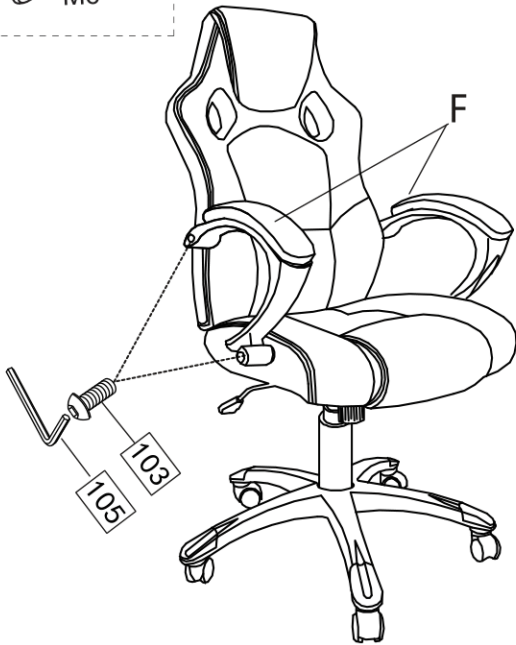

06

106 x2



107 x2



φ15

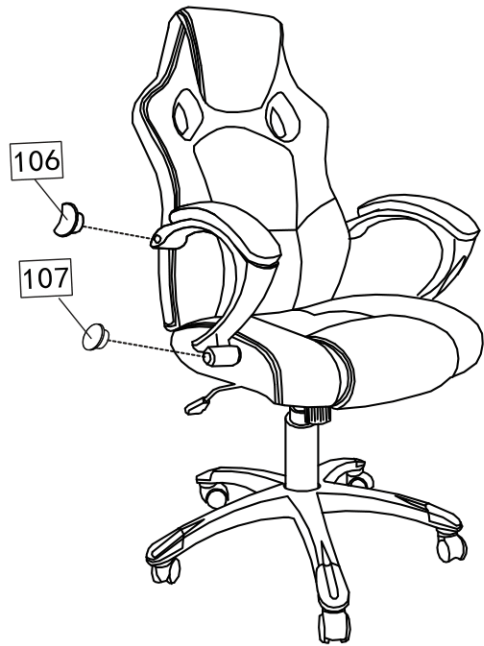

Done

