

- B1**  $\phi$  8x28 x16
- T1** x16
- M1**  $\phi$  15x12 x16
- C2**  $\phi$  20 x16
- W1** x8
- W2** x12
- F1** x8
- P2** 3x16 x10
- J23** x10
- N35** x4
- N21** x1
- S25** 4x20 x19

- X5** x5
- S9** 4x16 x10
- X19** x2
- D2** x5
- U42** x2
- A9** M4x28 x4
- G5** x8
- S4** 3x16 x8

- J11** x1
- P13** 3,5x13 x2

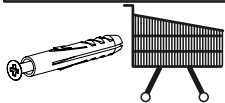

Nr				pcs	
1	575	350	5	3	1
2	1076	426	4	1	2
3	1214	398	15	1	2
4	1214	398	15	1	2
5	1214	378	15	1	2
6	236	373	15	1	1
7	236	373	15	2	1
8	860	398	18	1	1
9	860	398	18	1	1
10	1246	256	16	1	2
11	1046	596	16	1	2
14	1228	250	2	1	2
15	1228	591	2	1	2

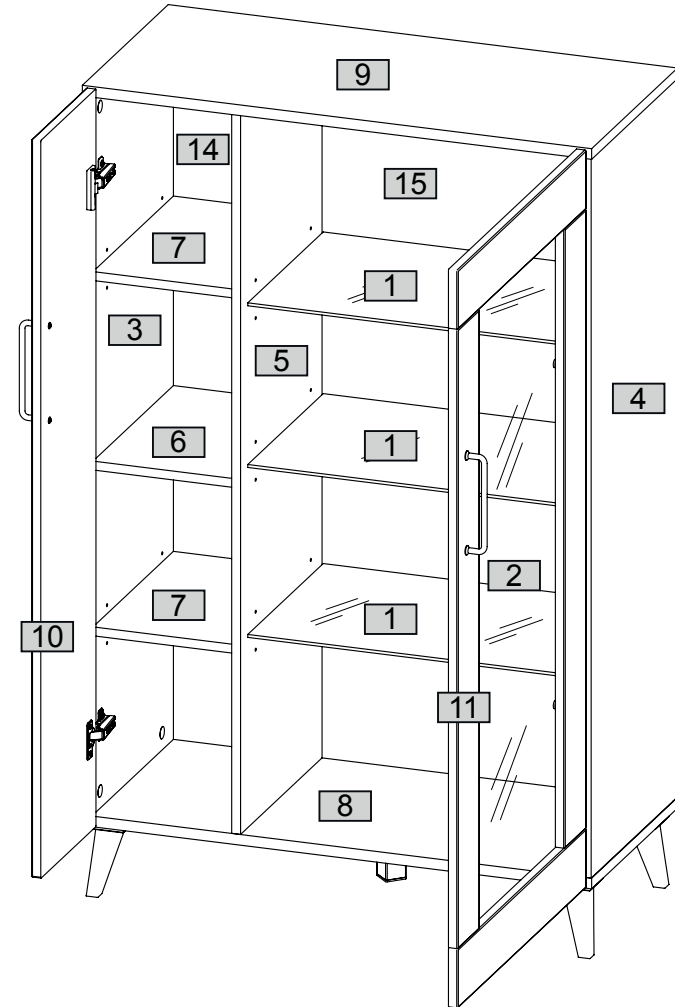

1

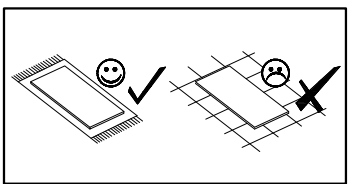
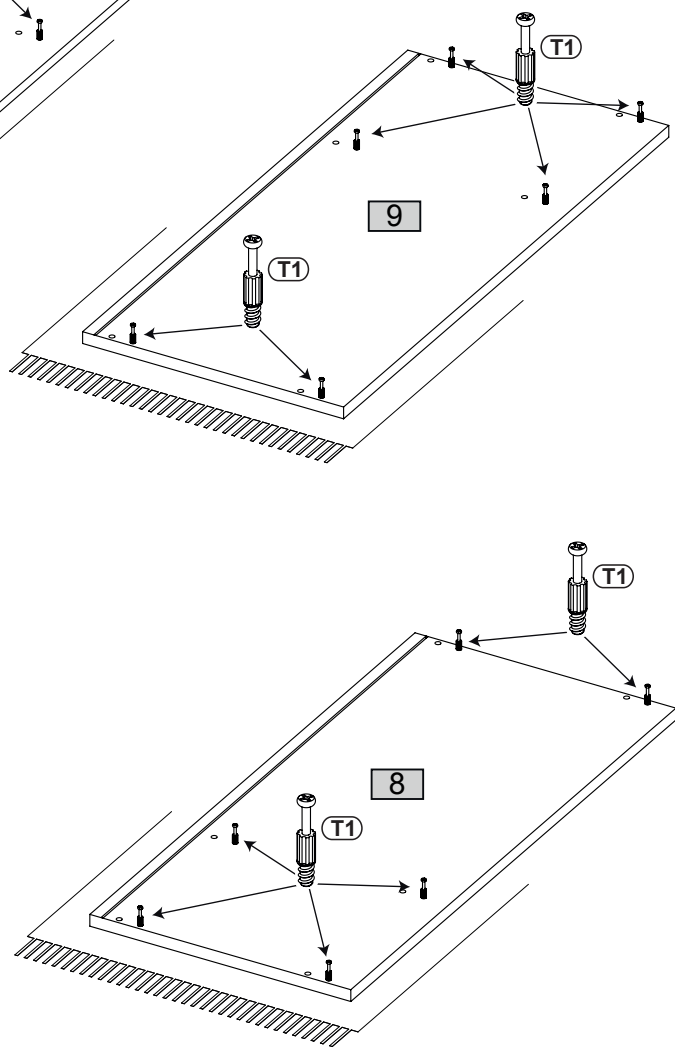
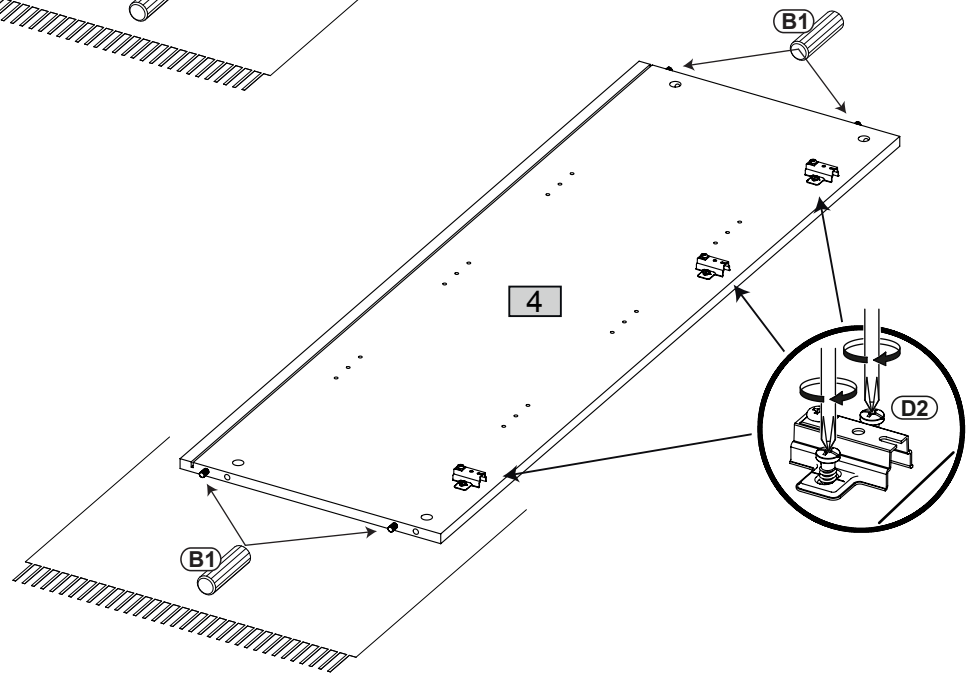
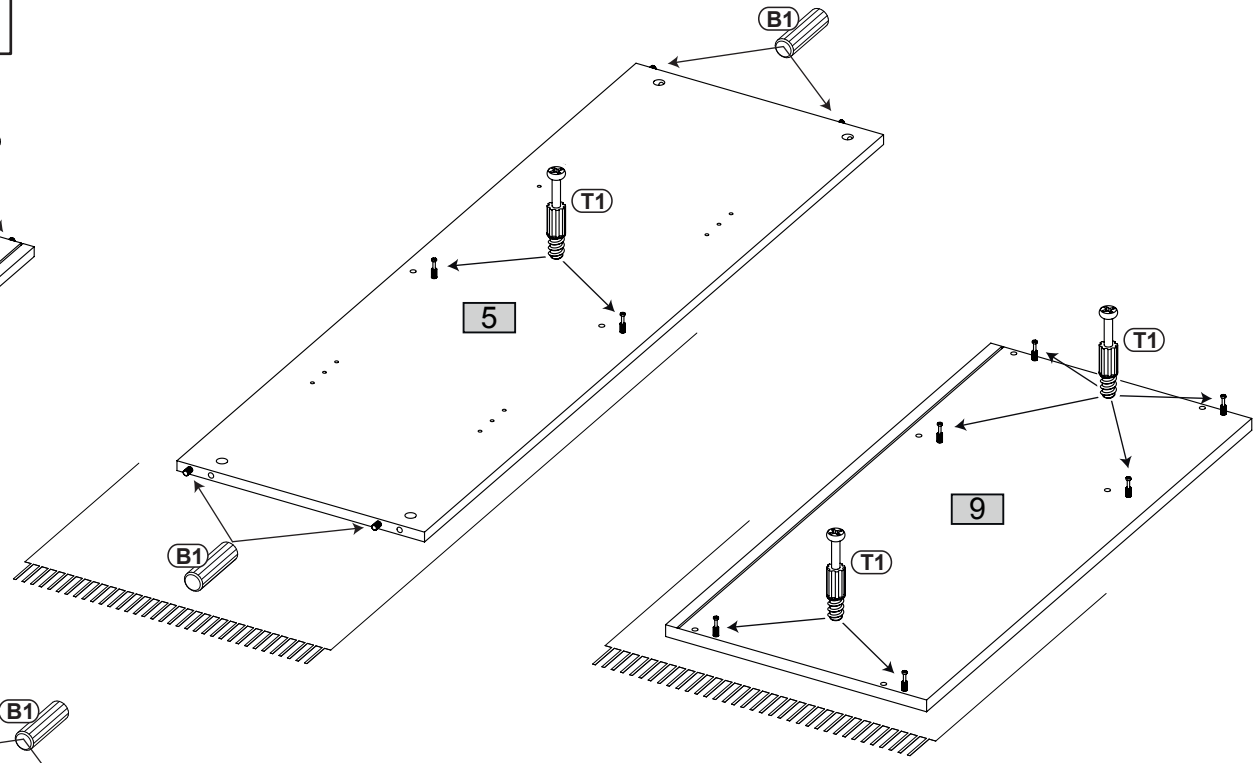
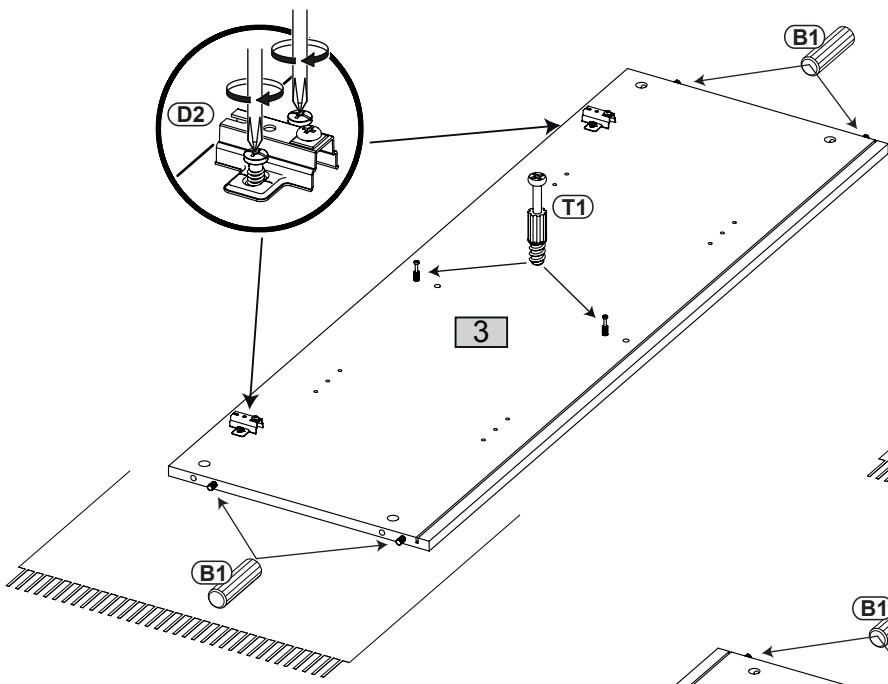
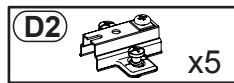
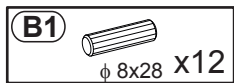
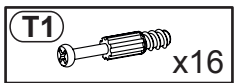

2

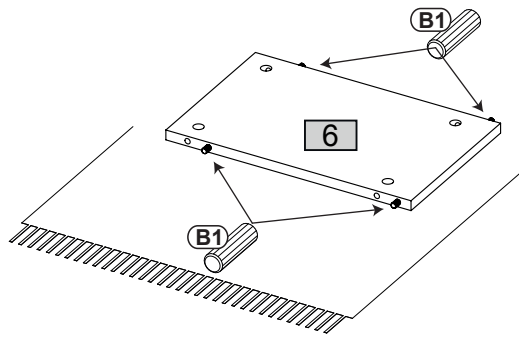
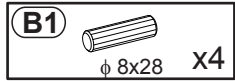

3

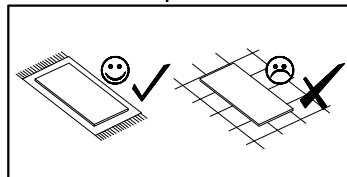
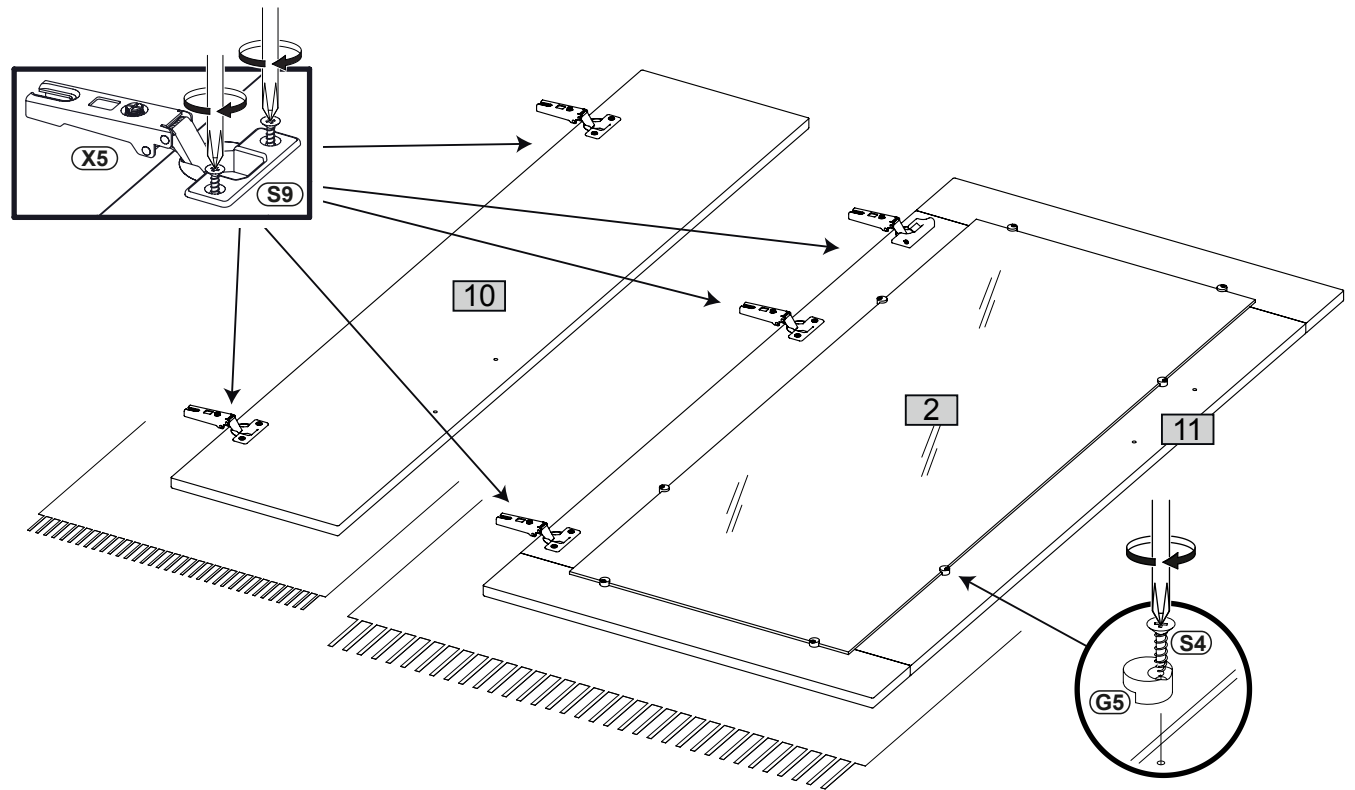
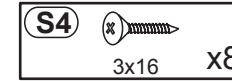
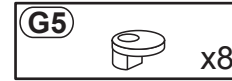
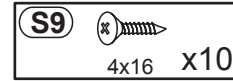
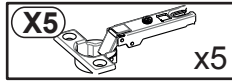

4

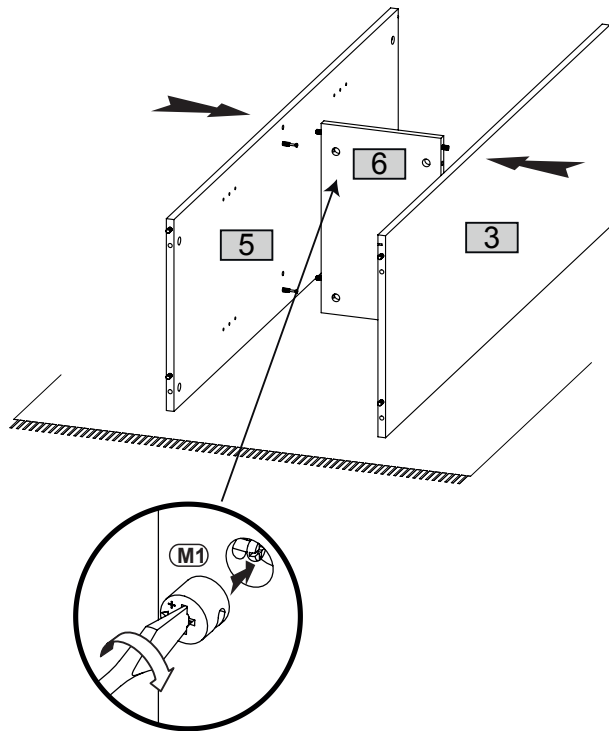

5

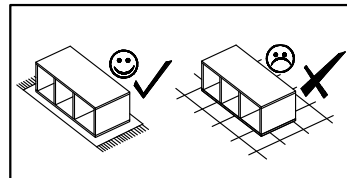
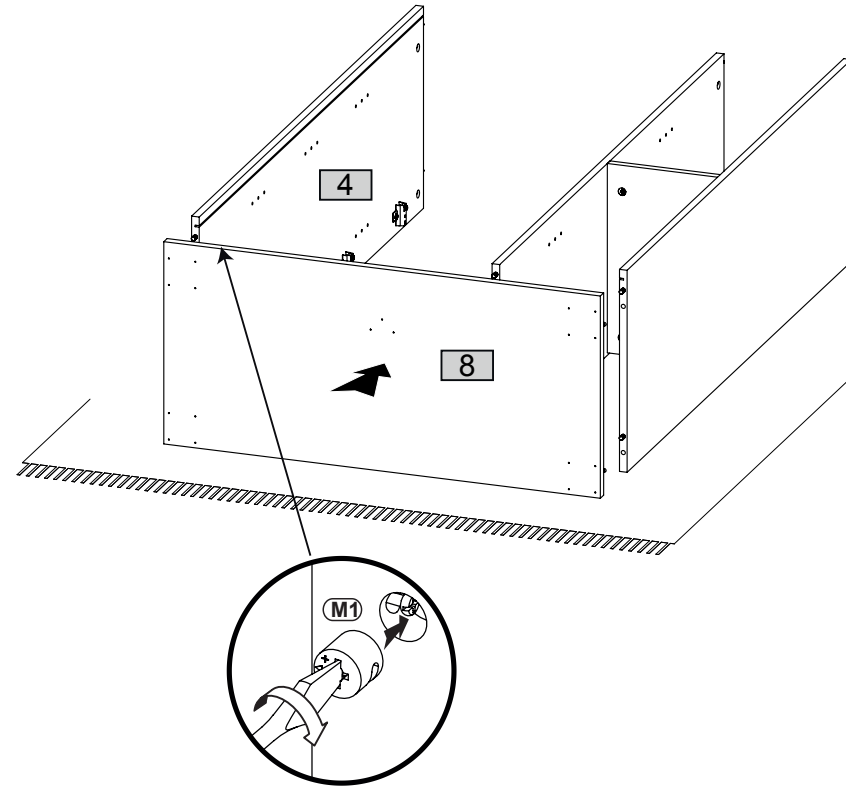

6

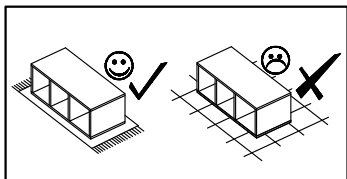
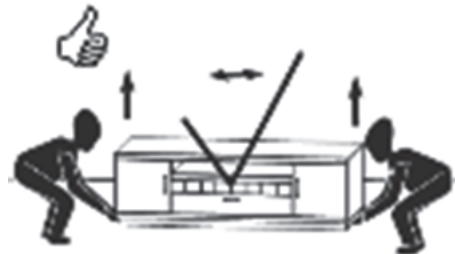
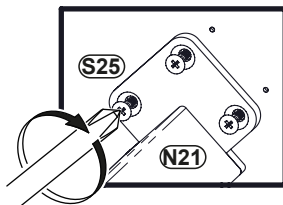
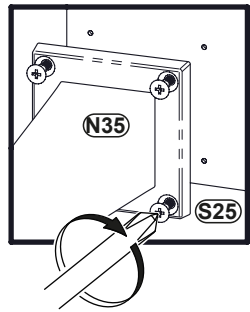
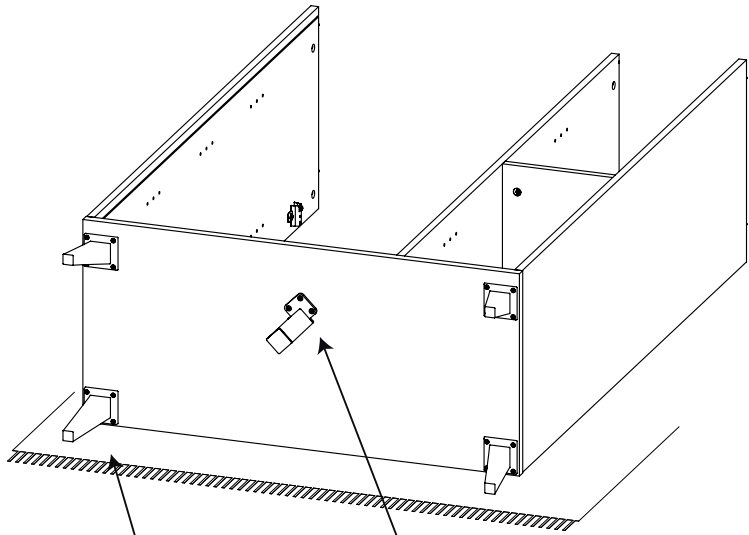
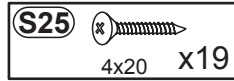
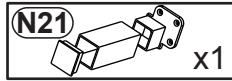
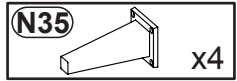

7

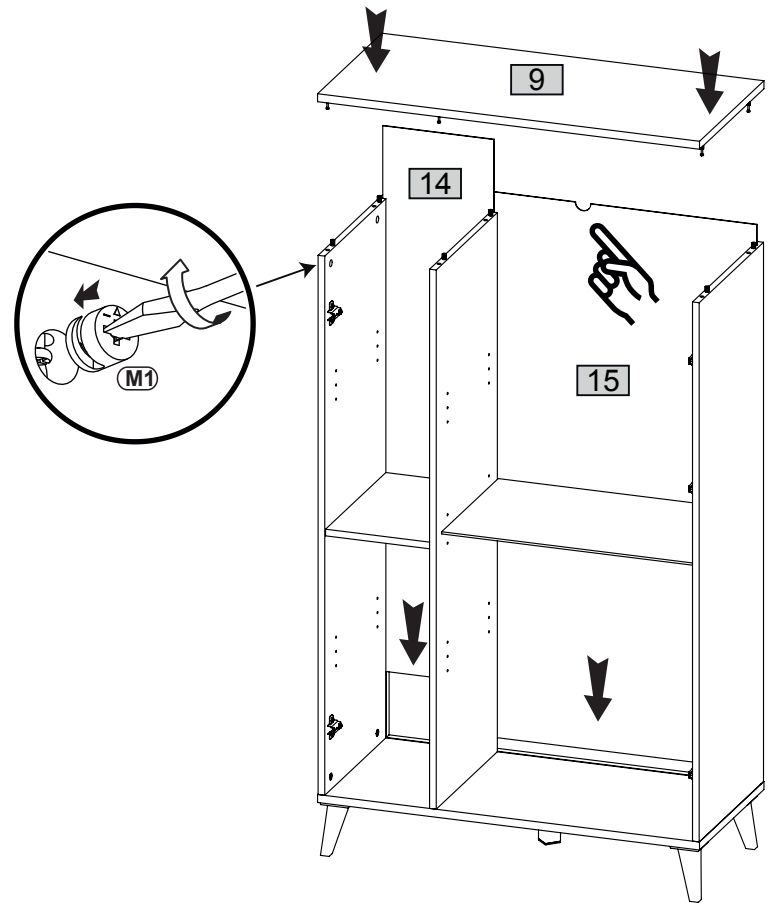

# 8

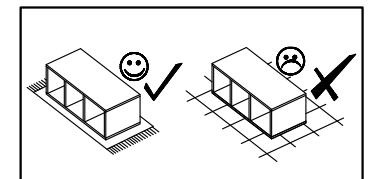
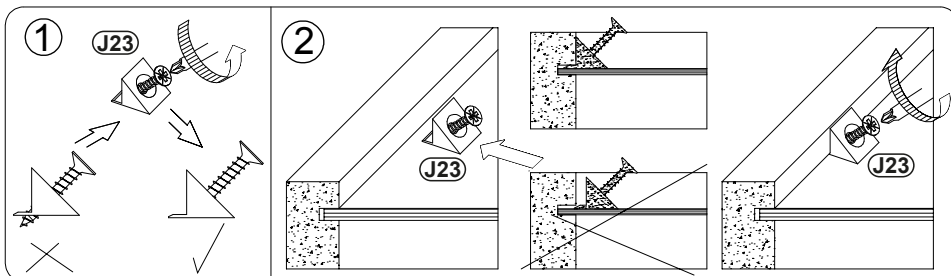
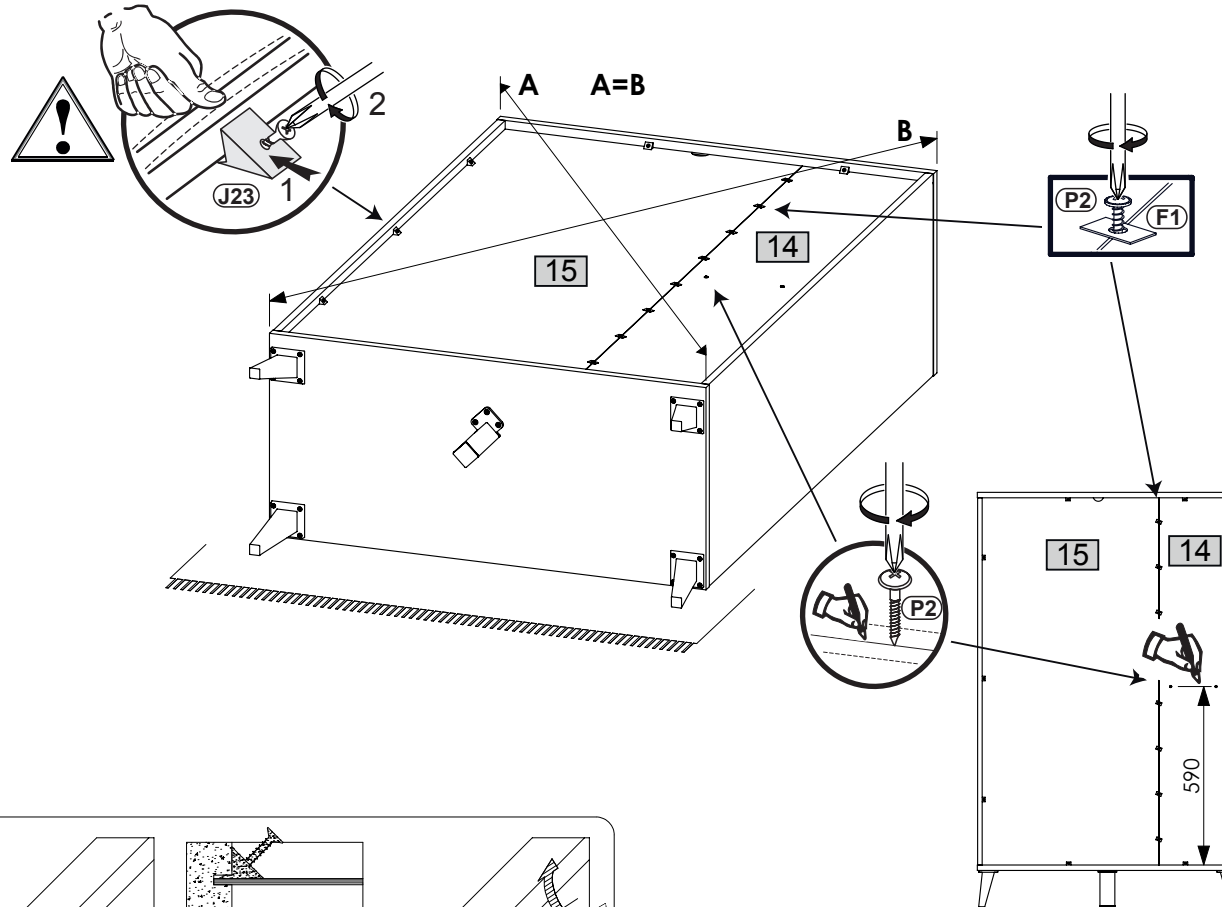
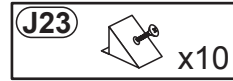
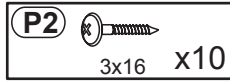
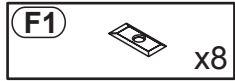

## 9

