

# RUBIC D 60 1D

**MEBLE-OKMED  
DEMKO**  
*Jesteśmy razem 30 lat!*

„MEBLE-OKMED” DEMKO - SPÓŁKA JAWNA  
ul. Kolejowa 13, 14-500 Braniewo, POLSKA  
[www.mebleokmed.pl](http://www.mebleokmed.pl) (+48) 55 243 27 26  
[firma@mebleokmed.pl](mailto:firma@mebleokmed.pl)

SERIA: .../...

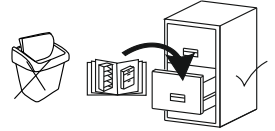

**RUBIC  
D60-1D** SERIA .../...  
Firma: .....  
Kraj: .....  
MEBLE OKMED Demko SP. J.  
14-500 Braniewo, ul. Kolejowa 13  
**MEBLE-OKMED  
DEMKO**  
*Jesteśmy razem 30 lat!*

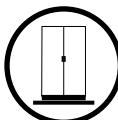
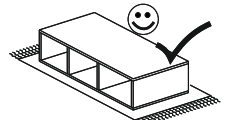
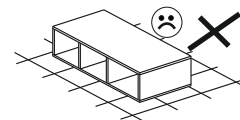
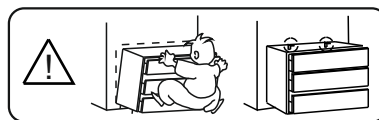
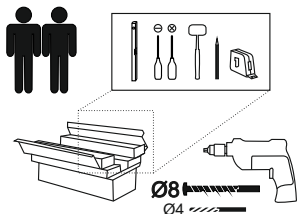
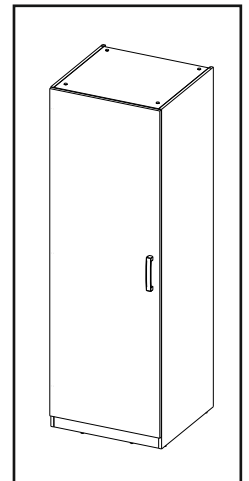
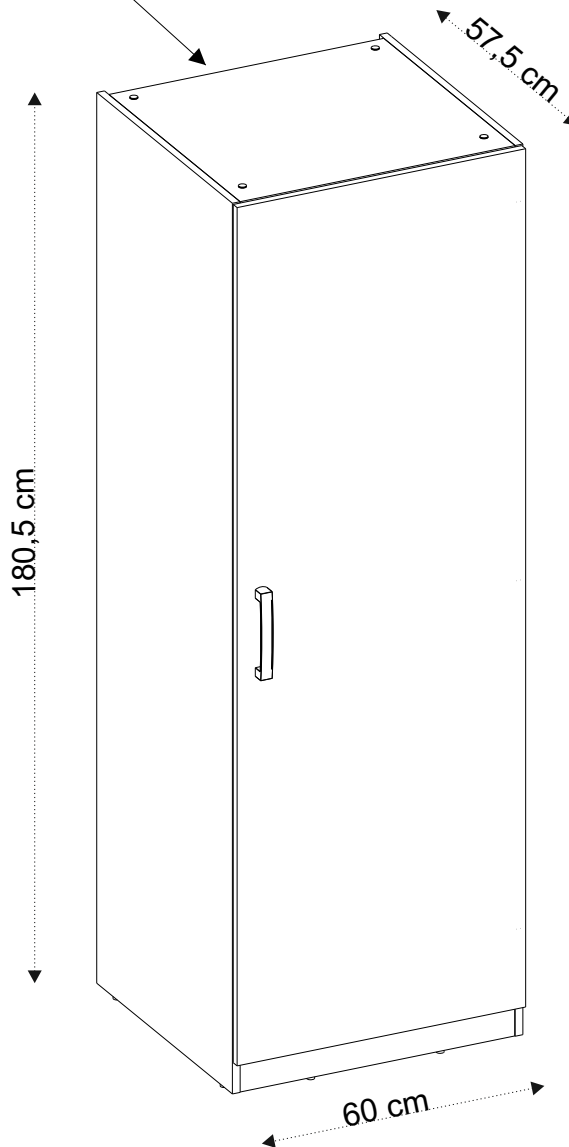



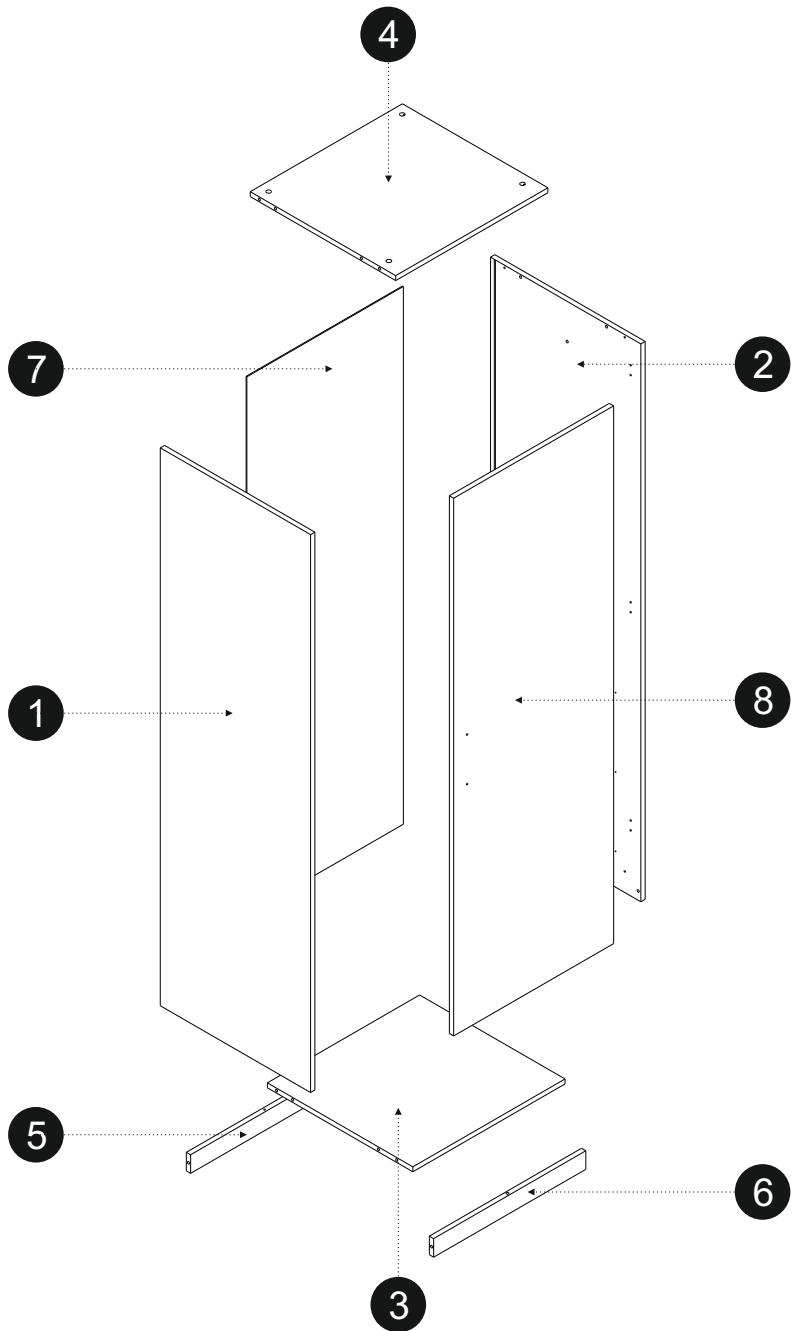















# RUBIC D 60 1D



1/3				
	L [mm]	W [mm]	T [mm]	
3	567	542	16	x1
4	567	542	16	x1
5	567	60	16	x1
6	567	60	16	x1
7	1735	583	3	x1
8	1735	596	16	x1

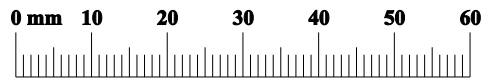

2/3				
	L [mm]	W [mm]	T [mm]	
1	1800	560	16	x1
2	1800	560	16	x1

 KS1   1	 KK1   1	 S1   8	 SG1   8	 ZM1B   8	 ZM1   4	 DS1   1	 LN160   1
 ZRP1   3	 KD1   14	 KRW1   1	 KO1   2	 MK1   2	 ZM1A   8	 W11   12	 W1   10
 W4   6	 WU1   2	 PK34   2					

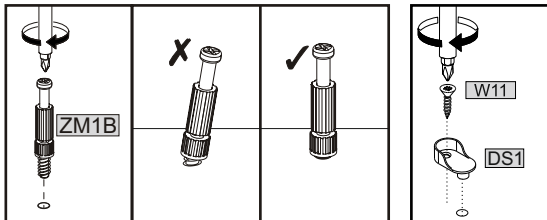

01

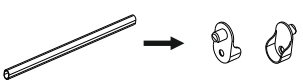
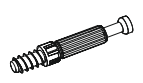

 L-450 mm		
PK34 2	DS1 1	ZM1B 8
 3,5x16		
W11 10		

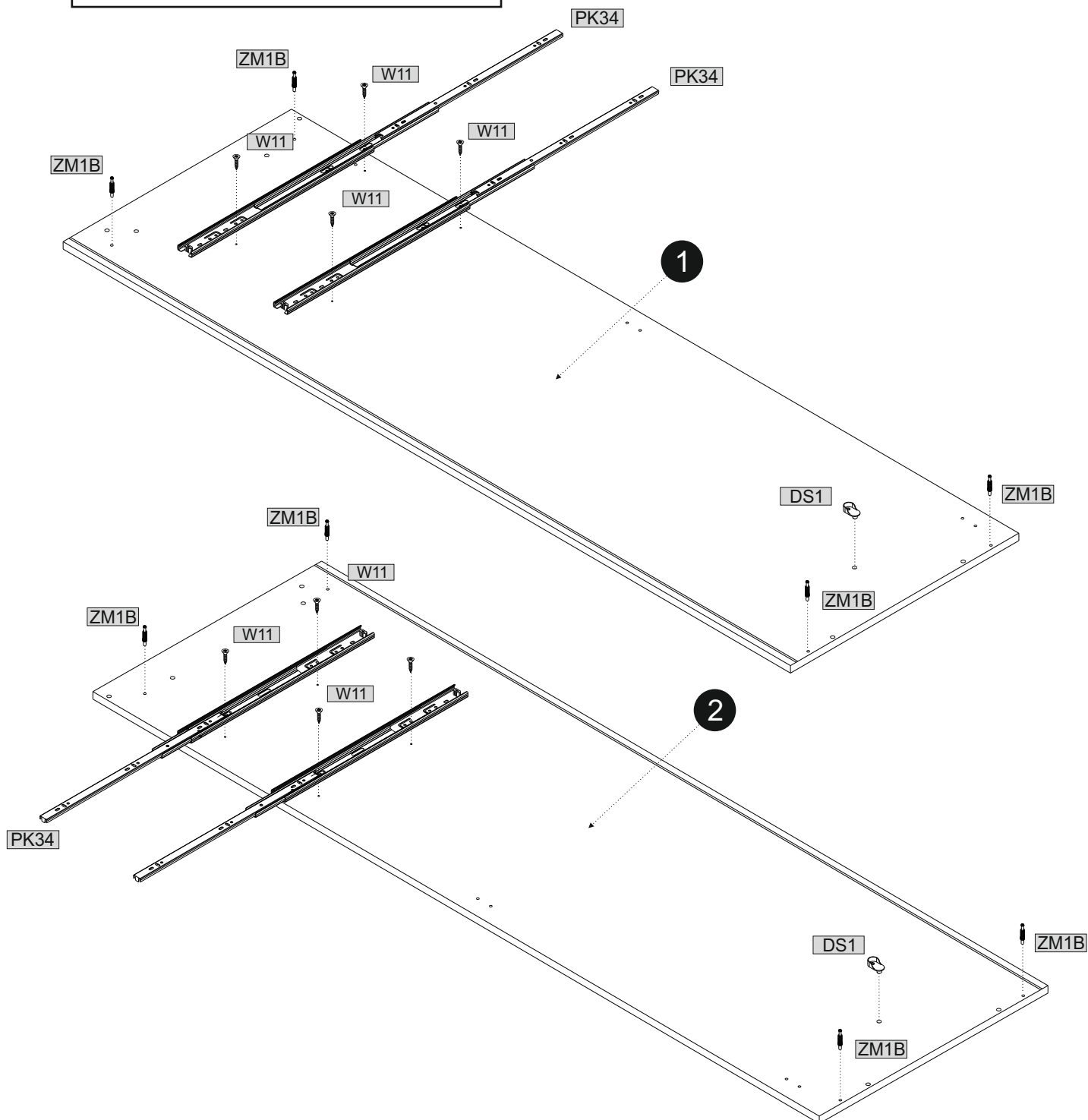
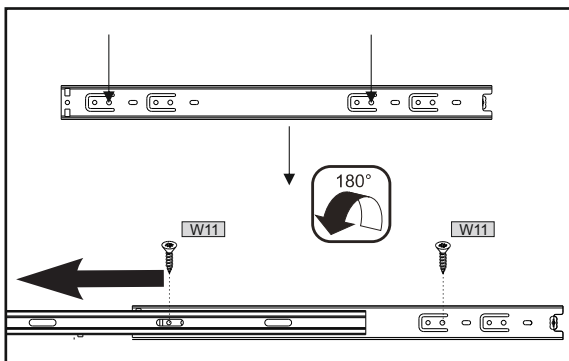

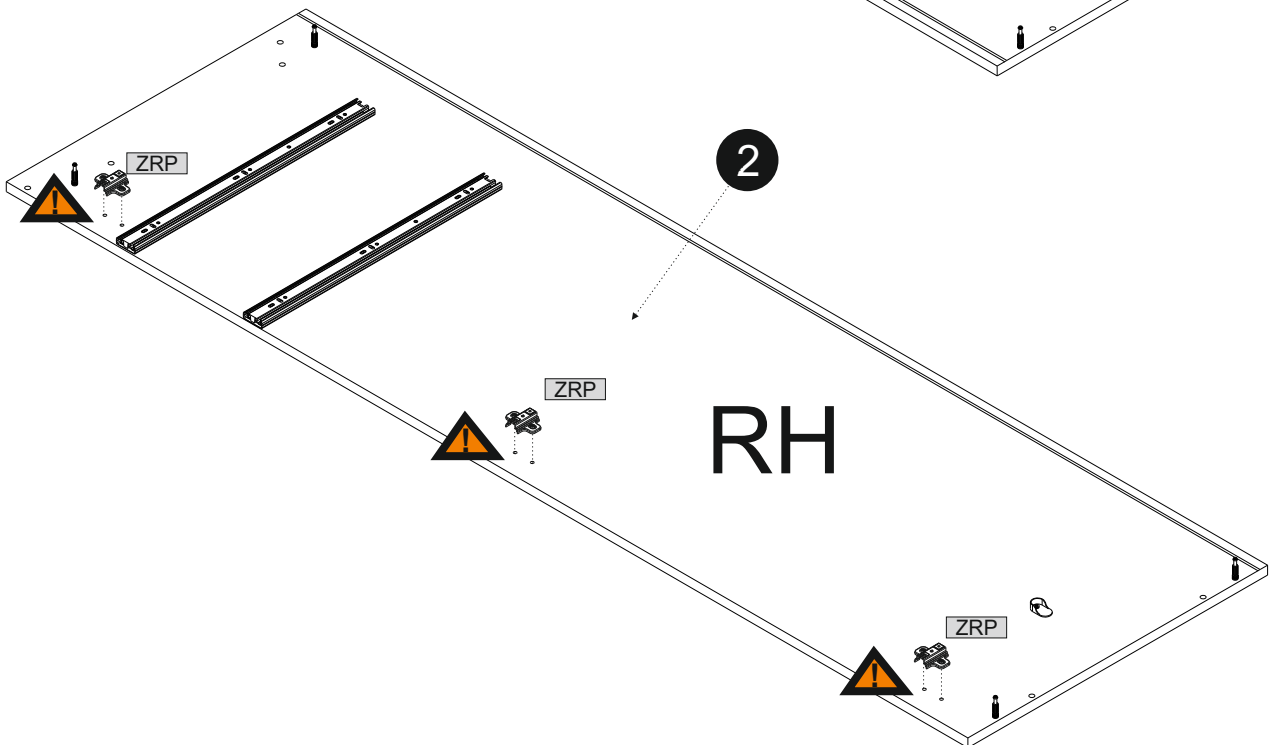
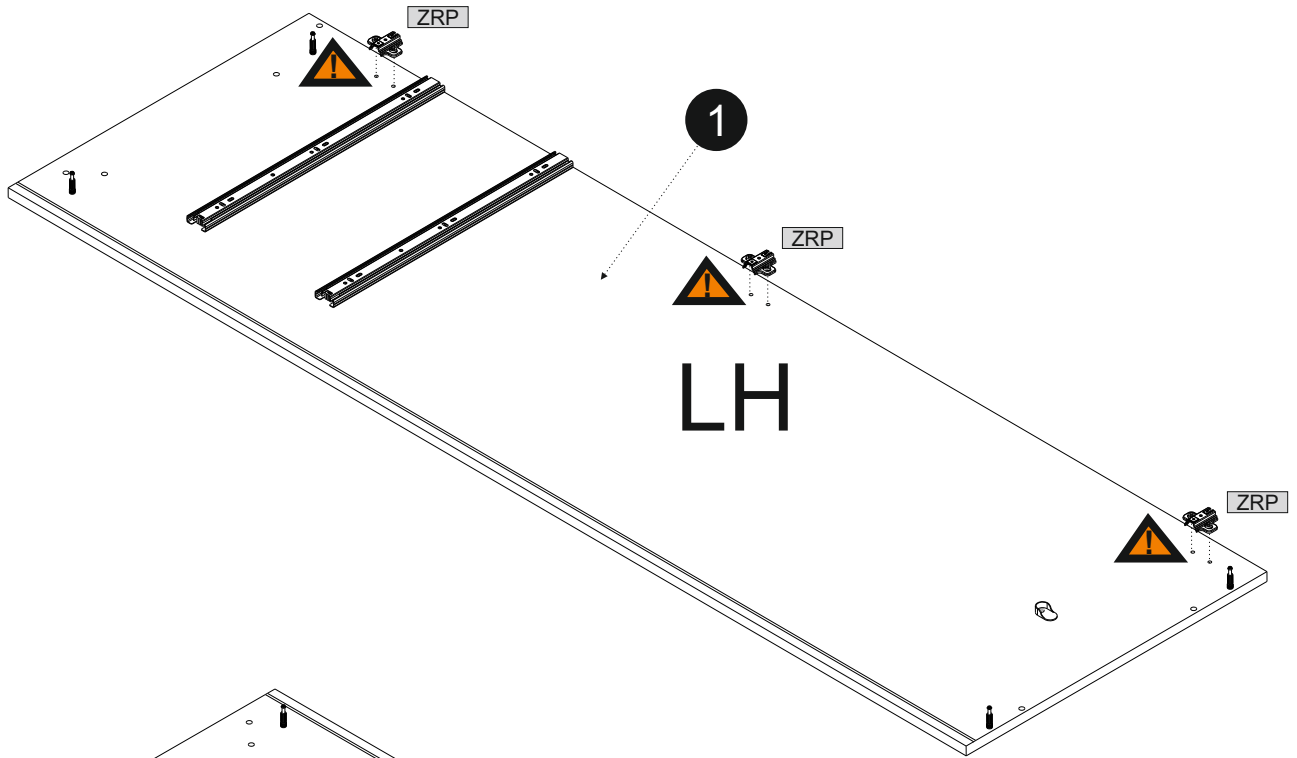
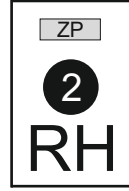
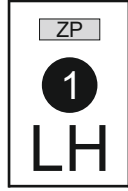
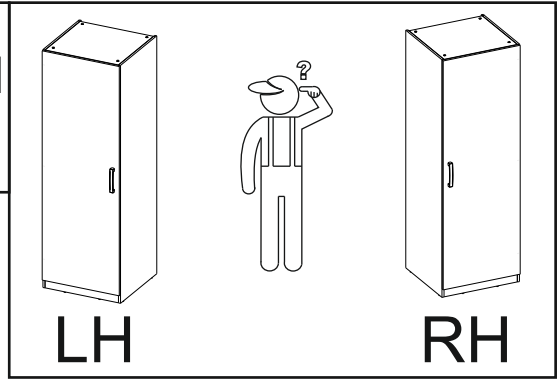
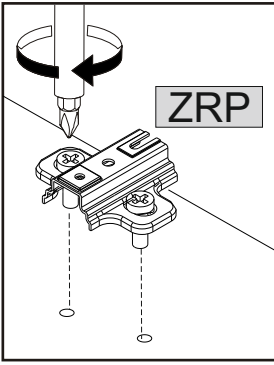
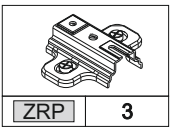
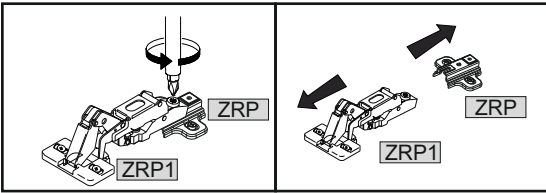

03

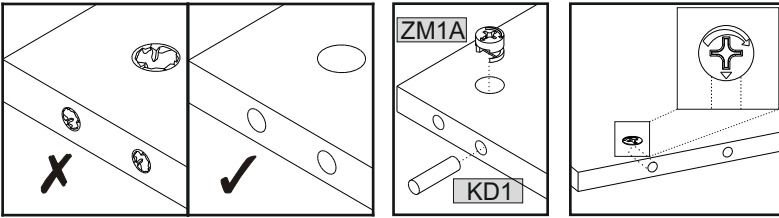

			8x35
ZM1A	8	KD1	14

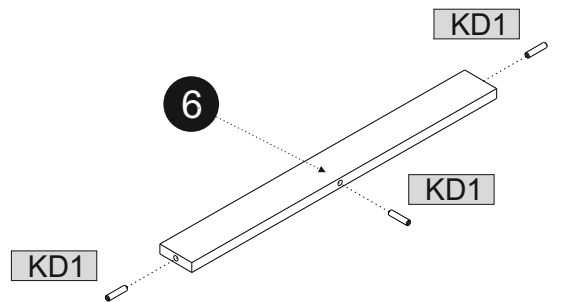
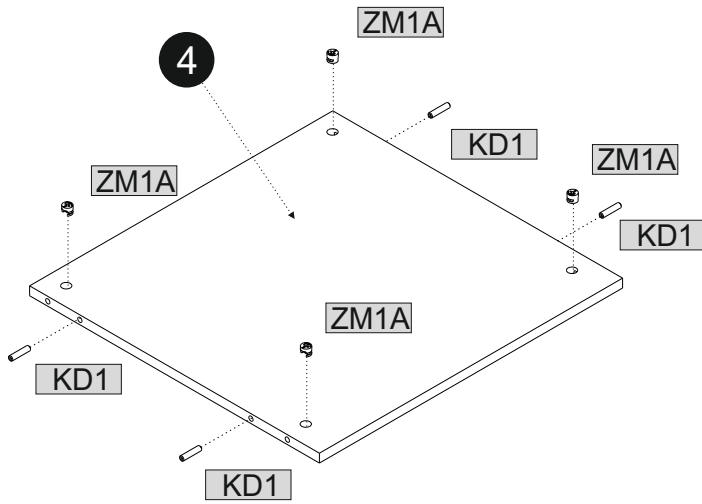
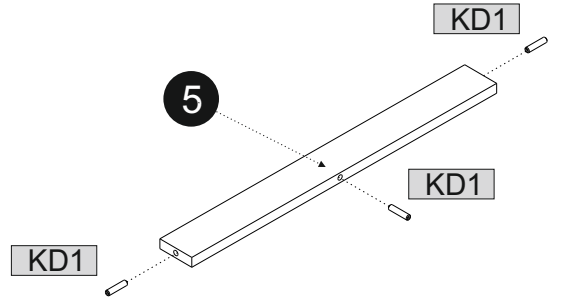
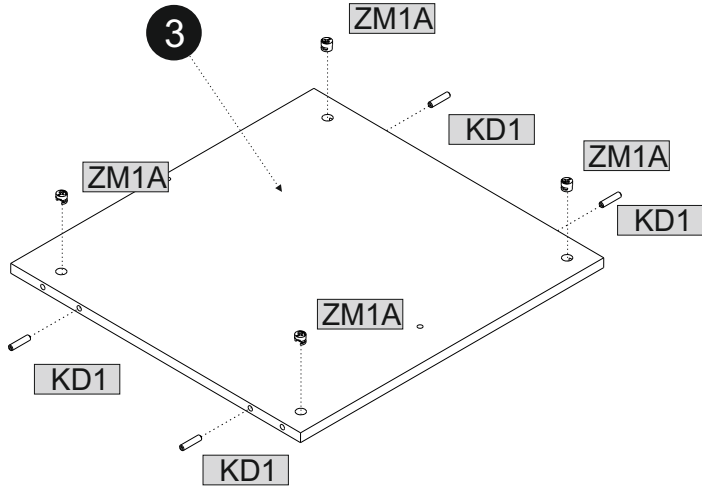

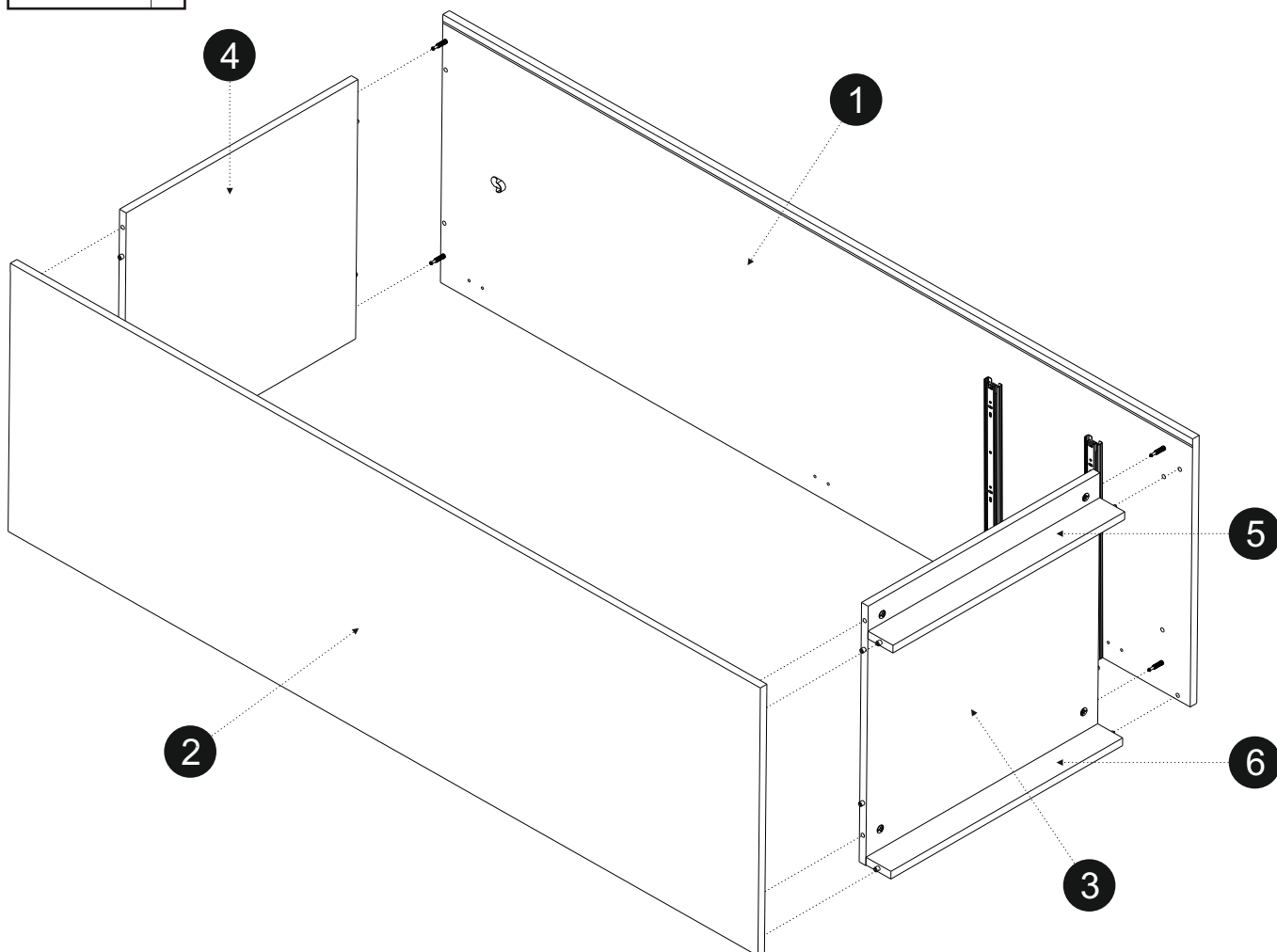
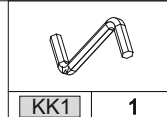
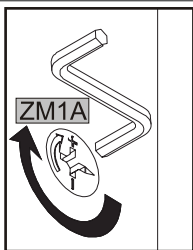
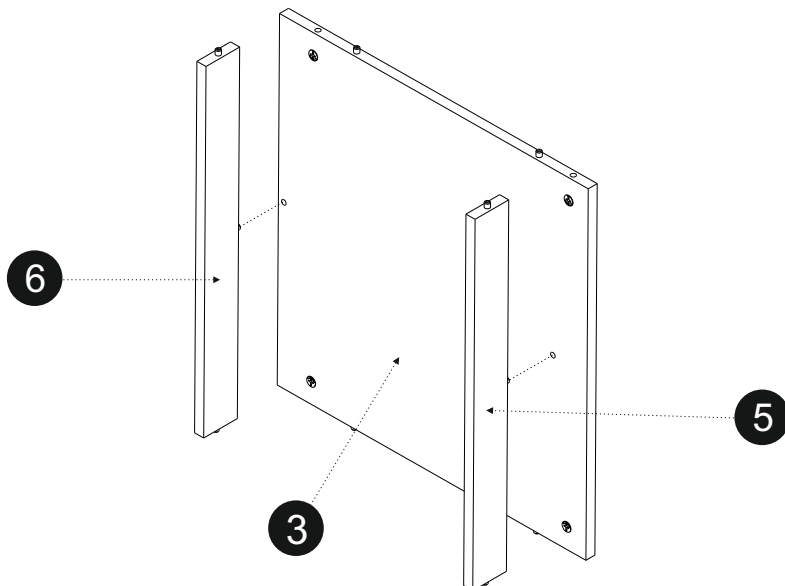

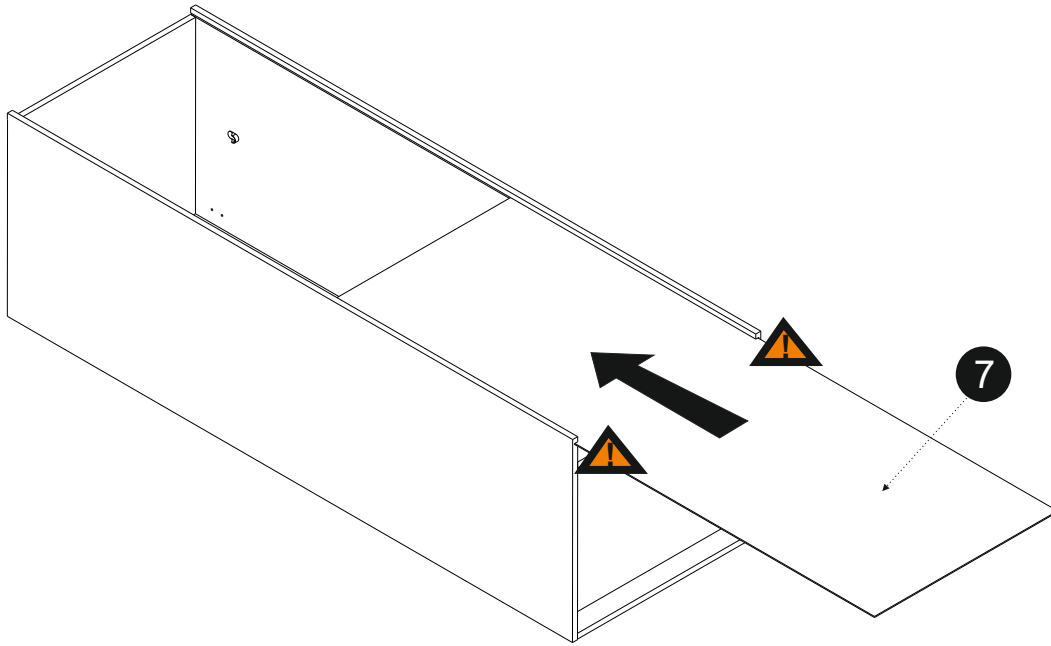
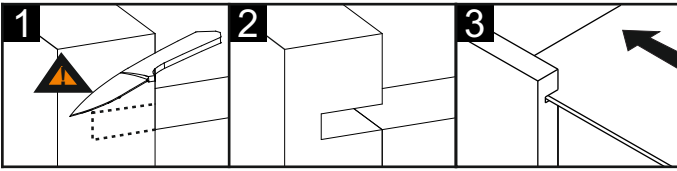

06

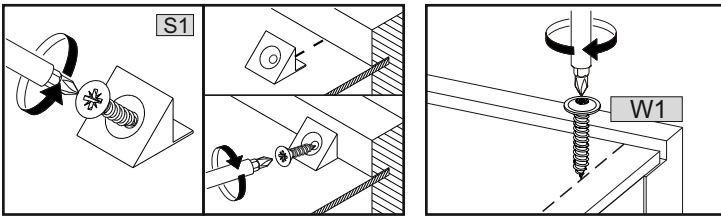

07



	3x16		
W1	10	S1	8

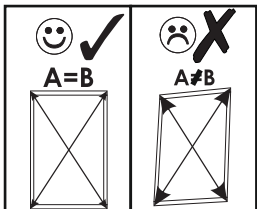
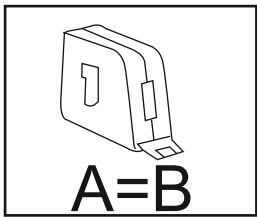
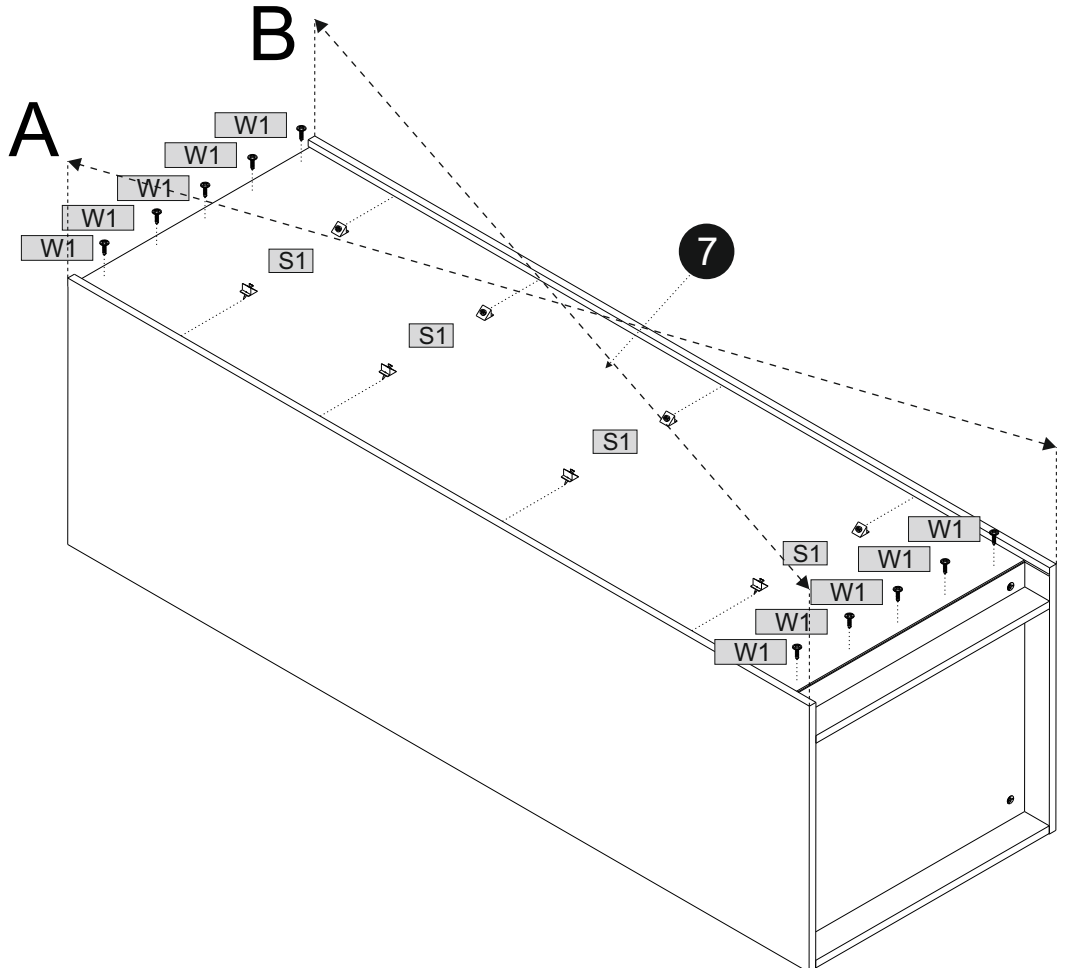

08

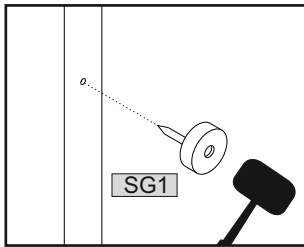

SG1	8

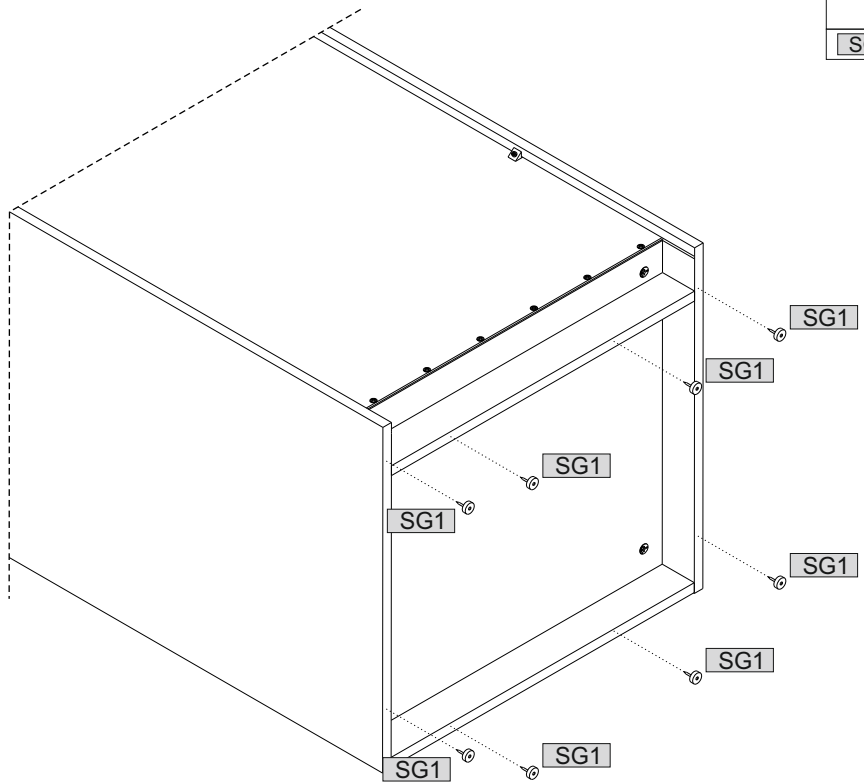

09

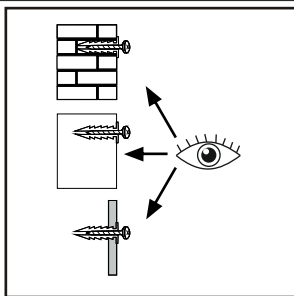

KS1	1	KRW1	1	W11	2

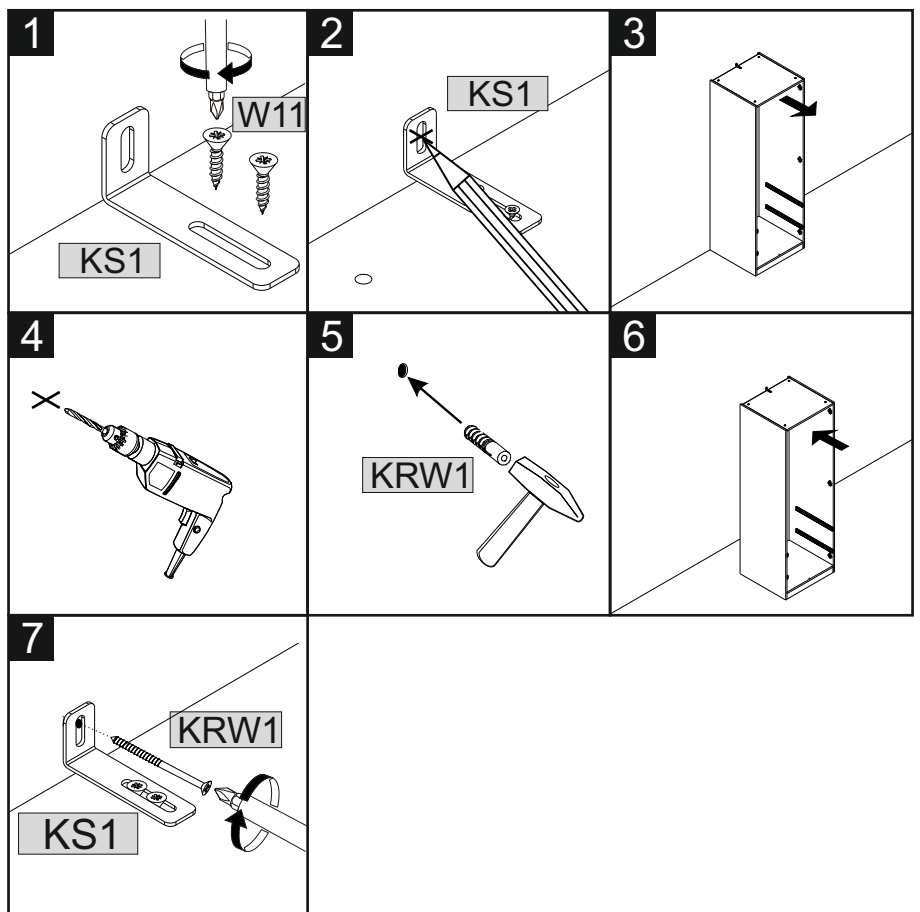
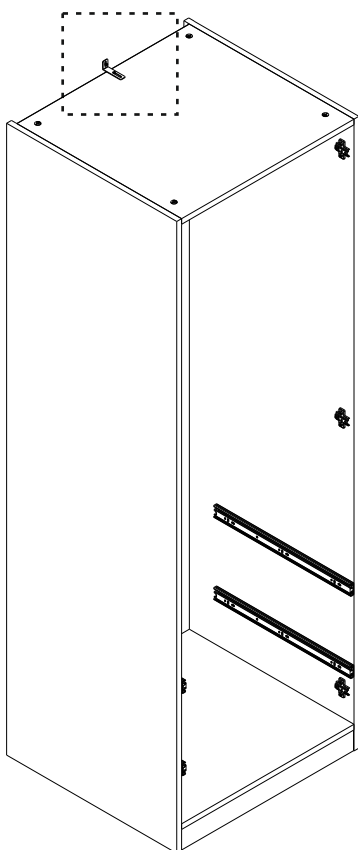



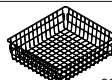
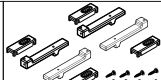

	60/200		
KO1	2	MK1	2

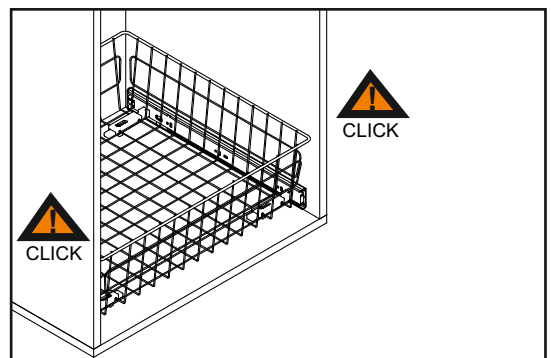
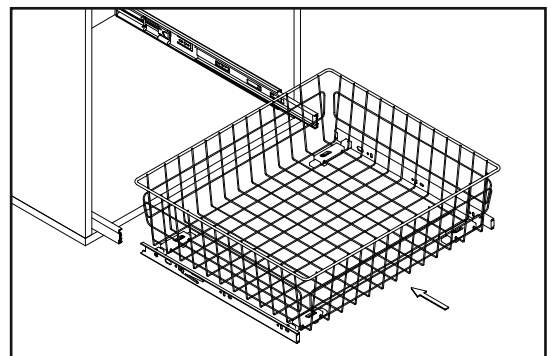
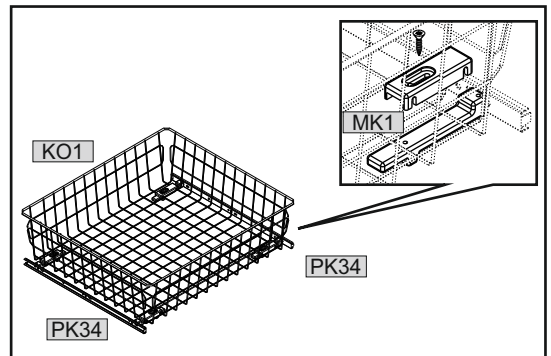
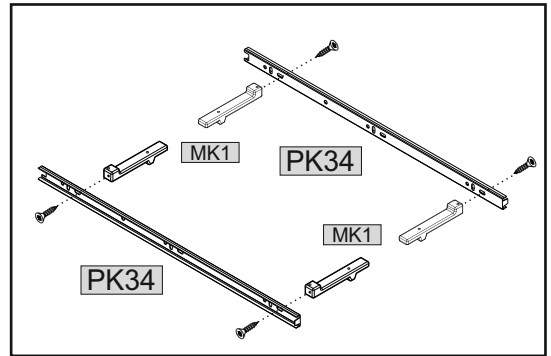
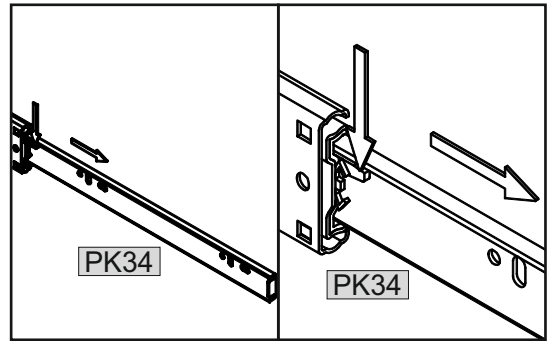
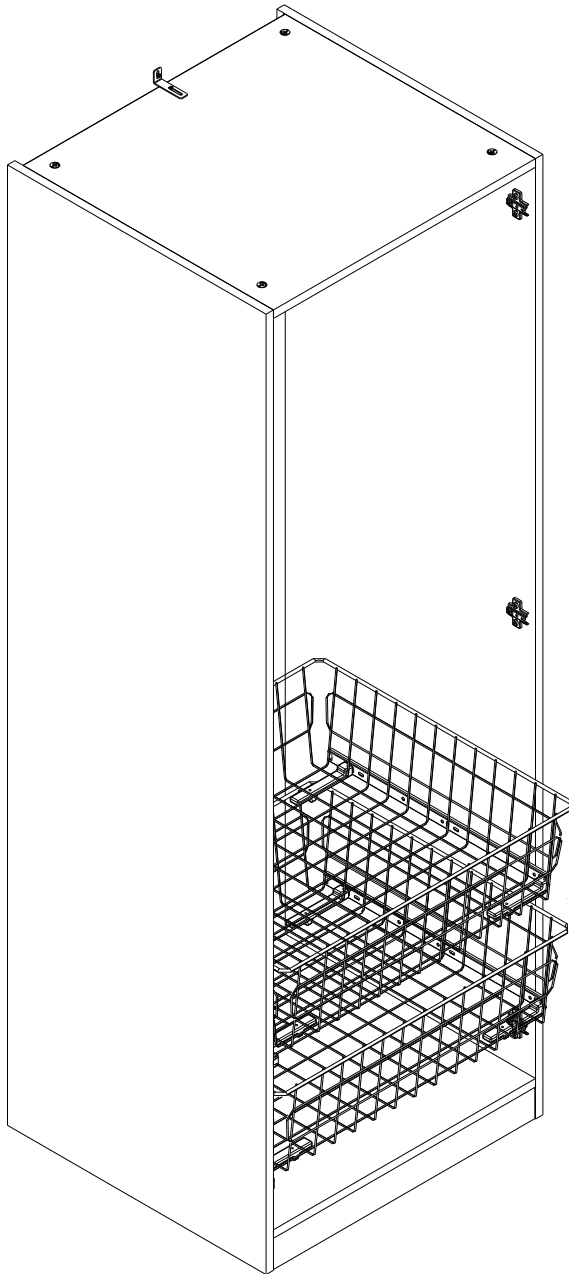
2x

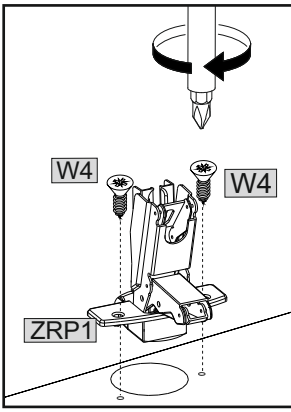

11



	4x13		
W4	6	ZRP1	3

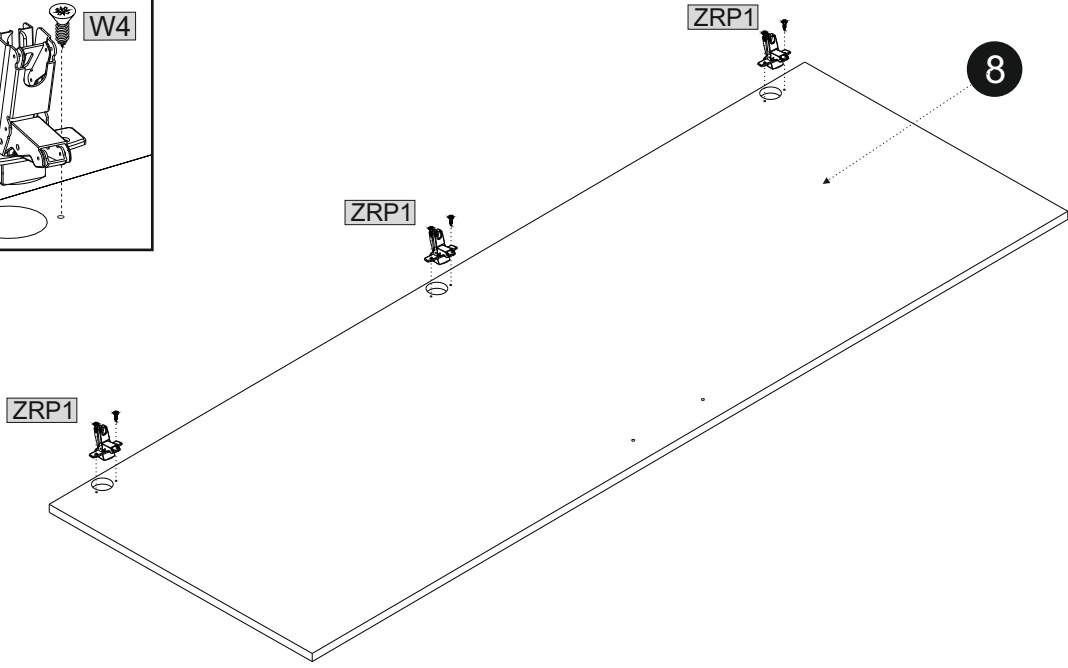

12

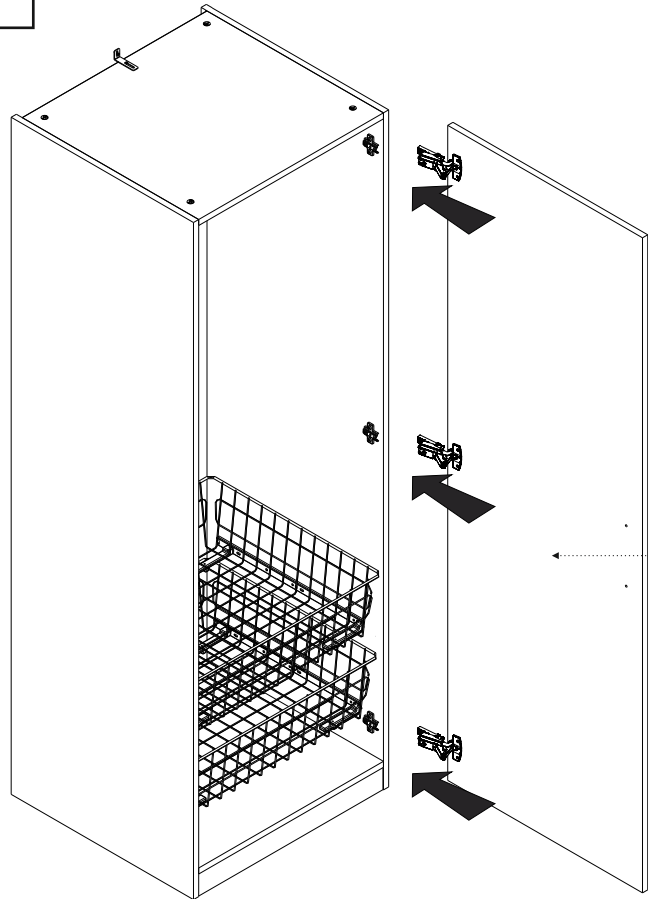
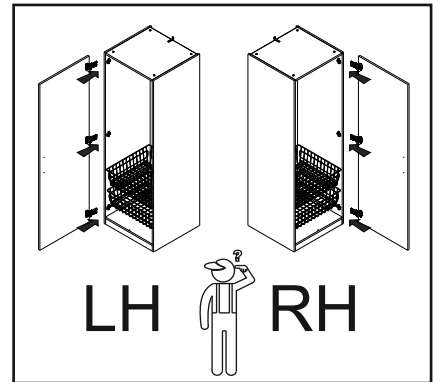
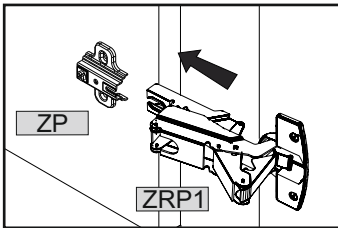

13

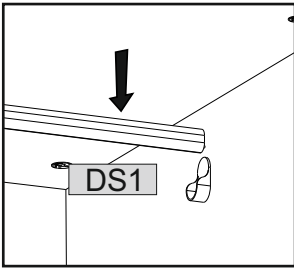

DS1	1

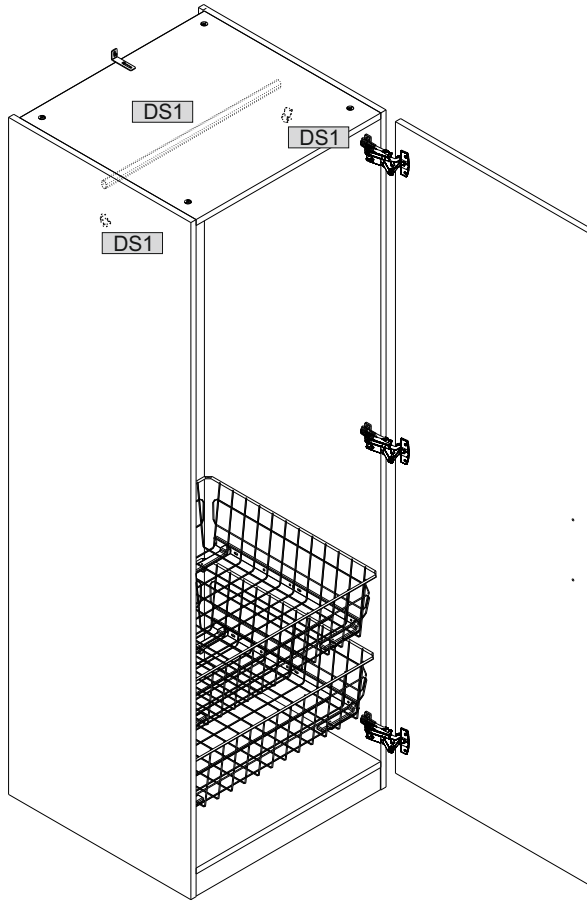

14

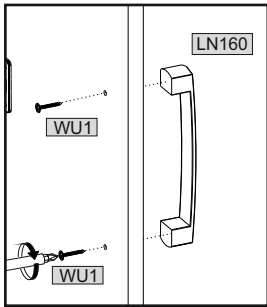

WU1	2	LN160	1

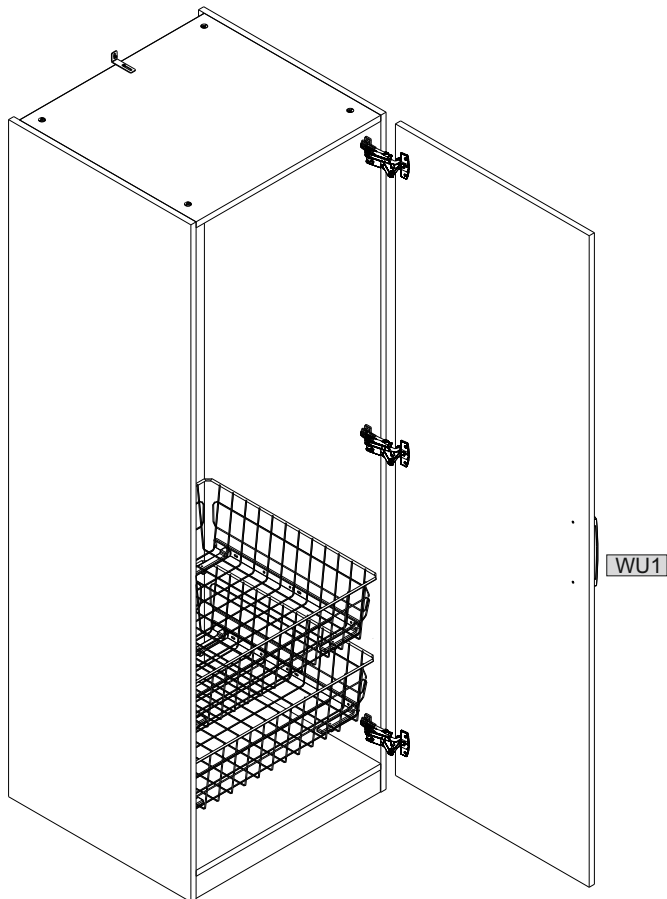

15

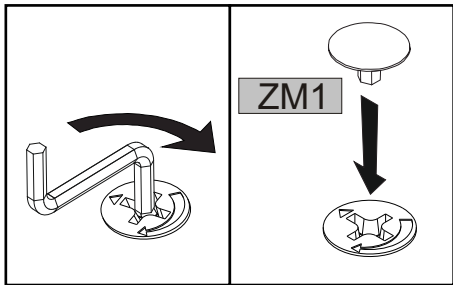

KK1	1	ZM1	4

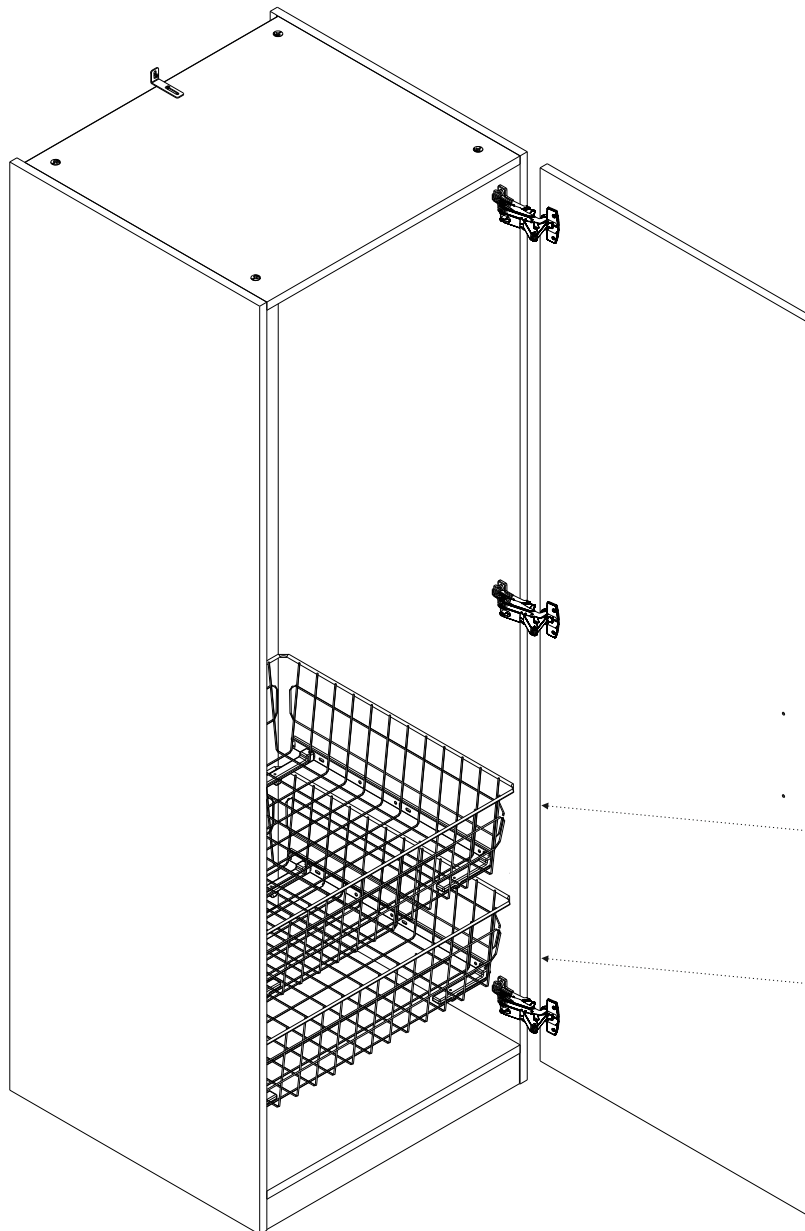
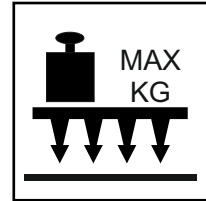

5 kg

5 kg