

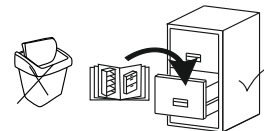

„MEBLE-OKMED” DEMKO - SPÓŁKA JAWNA
 ul. Kolejowa 13, 14-500 Braniewo, POLSKA
www.mebleokmed.pl (+48) 55 243 27 26
firma@mebleokmed.pl

SERIA: .../...



MONOSS
Witryna 4D SERIA .../...
TYTUŁ WITRYNY SZARY, GRAFIT / SZKŁO
KORPUS: SZARY, GRAFIT
MEBLE OKMED DEMKO
 MEBLE OKMED Demko SP. J.
 14-500 Braniewo, Ul. Kolejowa 13
Jesteśmy razem 30 lat!

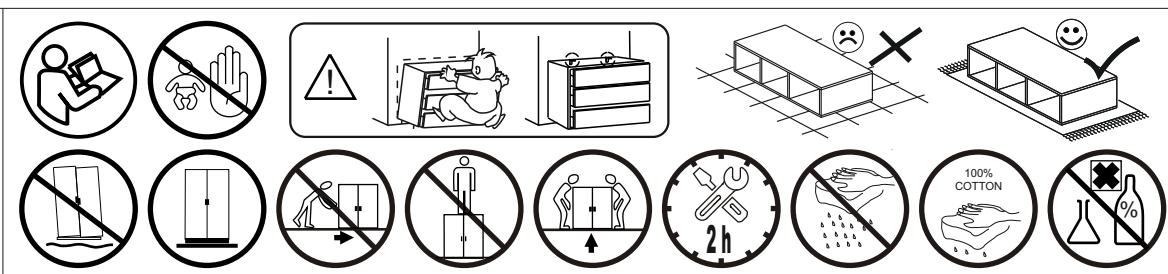
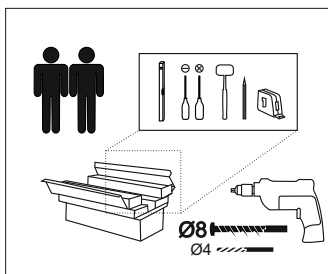
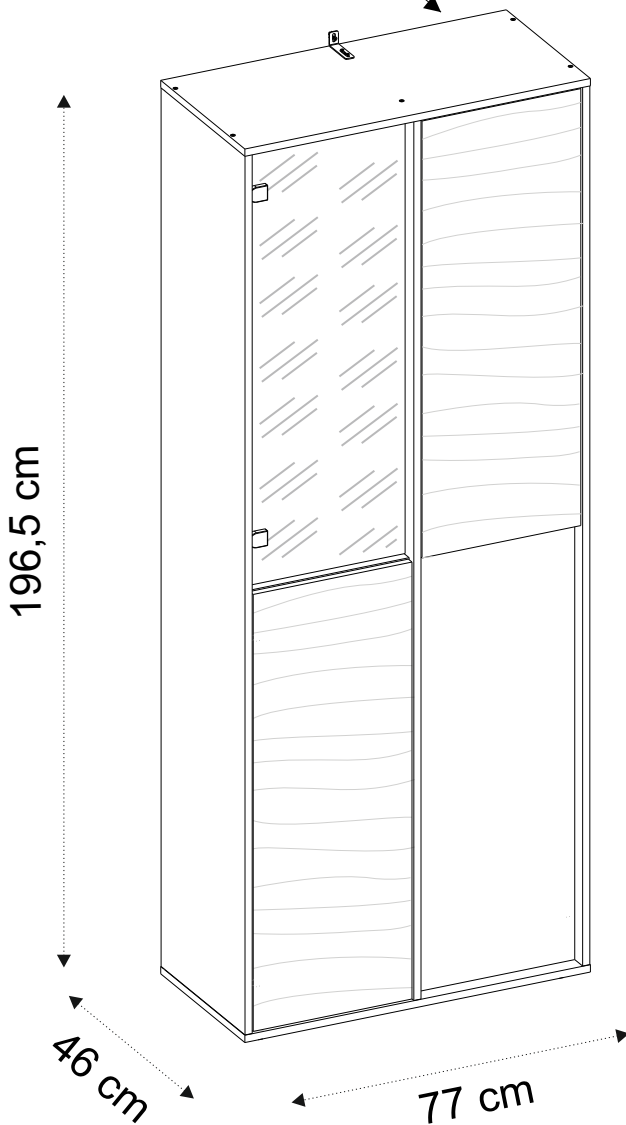
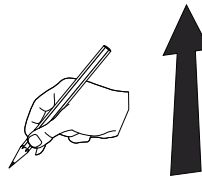

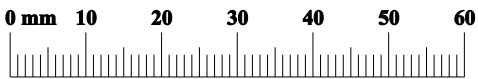
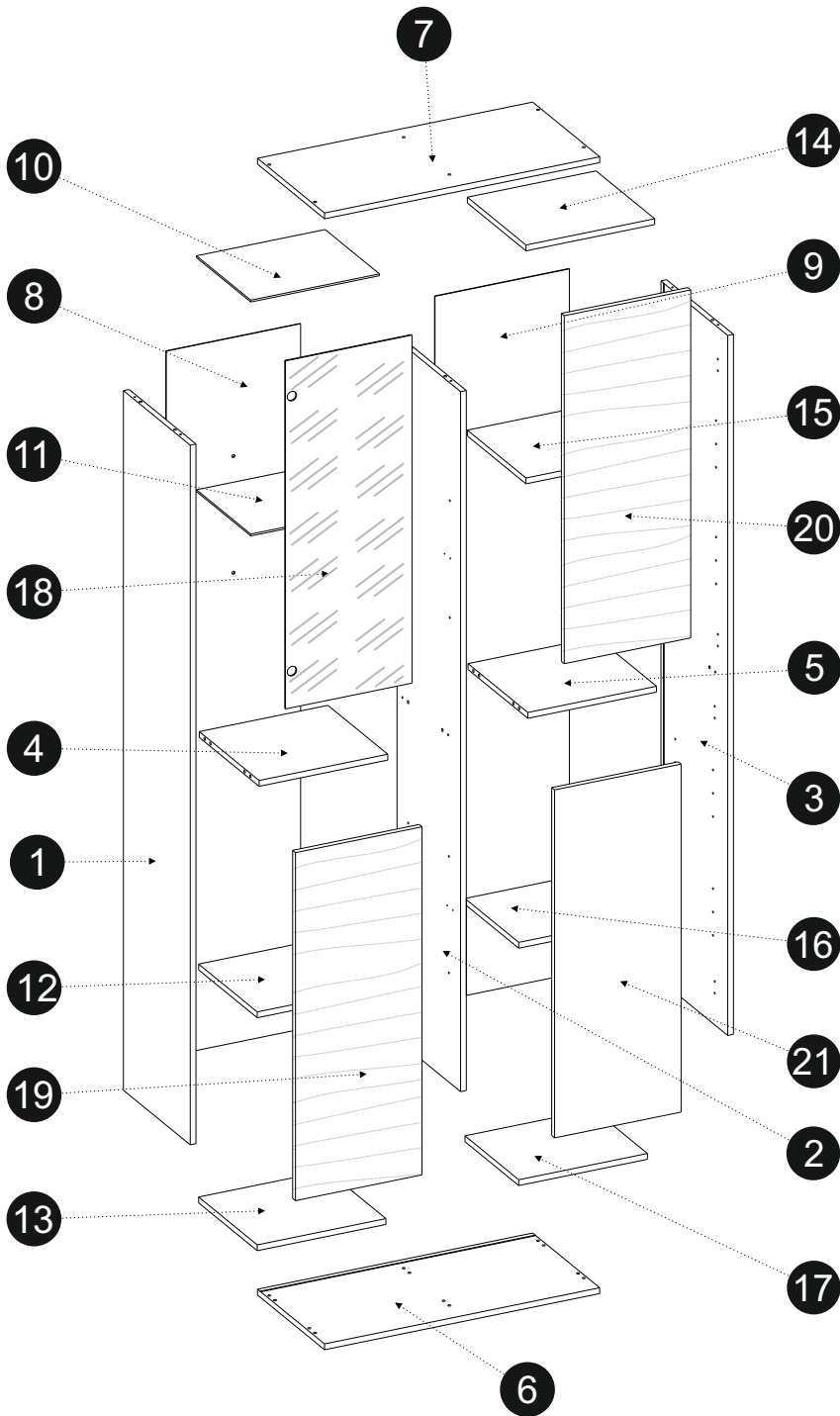

KS1 1	KK1 1	ZKL1 1	OK1 4	PL1 15	PP 32
S1 12	SS3 5	ZM1 8	ZSW1 2	ZSW 2	KD1 20
ZWP1 6	ZWP 6	KRW1 1	K1 12	ZM1B 8	ZM1A 8
W11 10	W1 15	W4 12	W6 5		

1/3

	L	W	T	
10	360	304	5	x1
11	360	304	5	x1
16	360	301	16	x1
17	360	301	16	x1
18	954	354	4	x1
19	954	354	16	x1
20	954	354	16	x1
21	954	354	16	x1

2/3

	L	W	T	
1	1918	374	16	x1
3	1918	374	16	x1
6	770	375	16	x1
7	770	375	16	x1
8	1934	376	3	x1
9	1934	376	3	x1

3/3

	L	W	T	
2	1918	356	16	x1
4	360	335	16	x1
5	360	335	16	x1
12	360	328	16	x1
13	360	328	16	x1
14	360	328	16	x1
15	360	328	16	x1

01

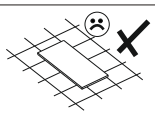
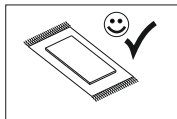

ZM1B	4	KD1	8	PP	16

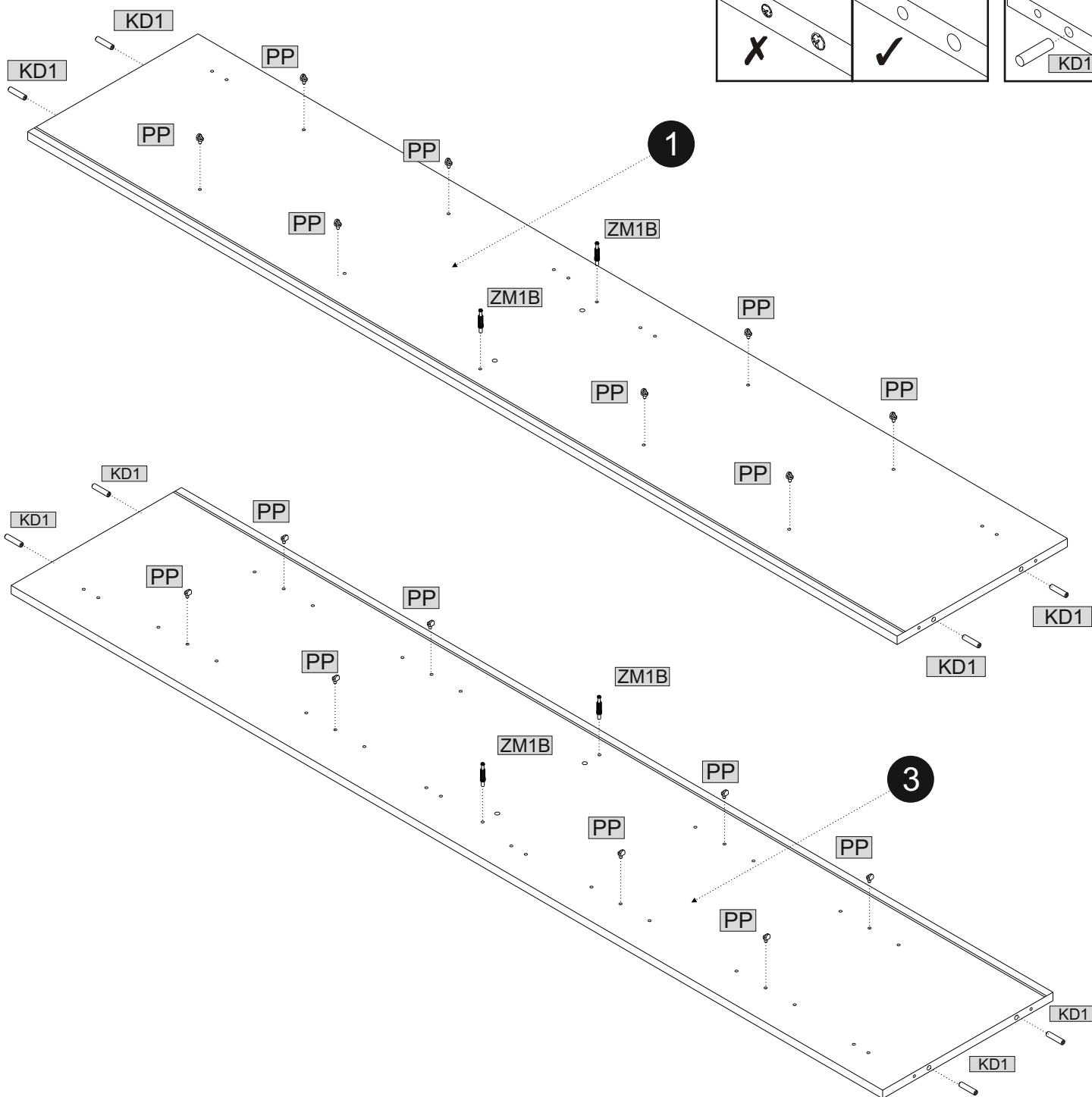
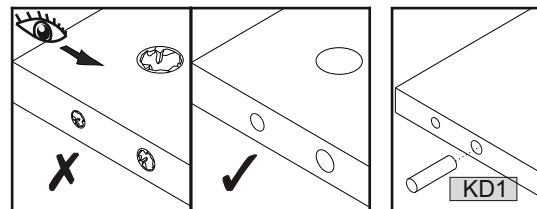
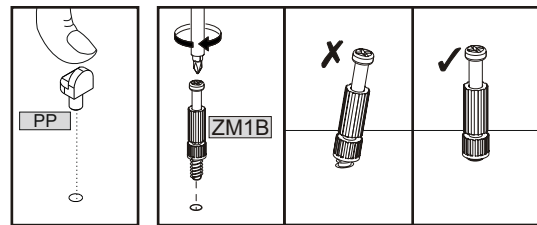

02

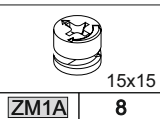
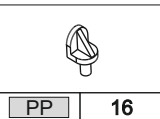
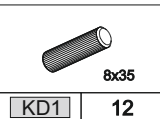
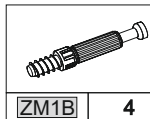
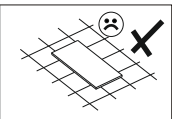
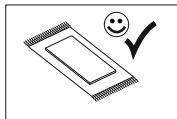

ZM1B 4

KD1 12

PP 16

ZM1A 8

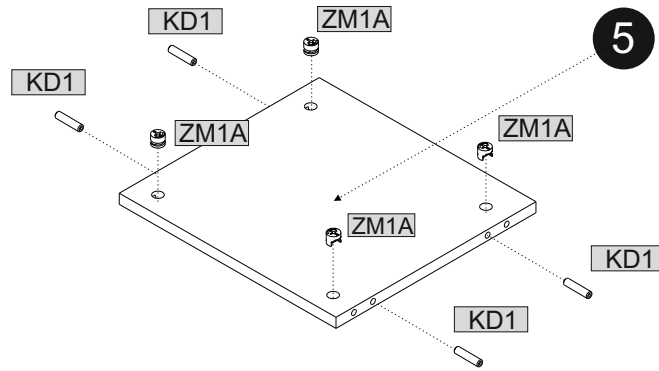
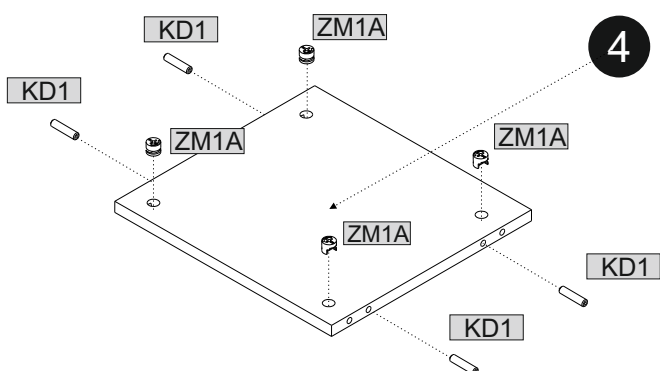
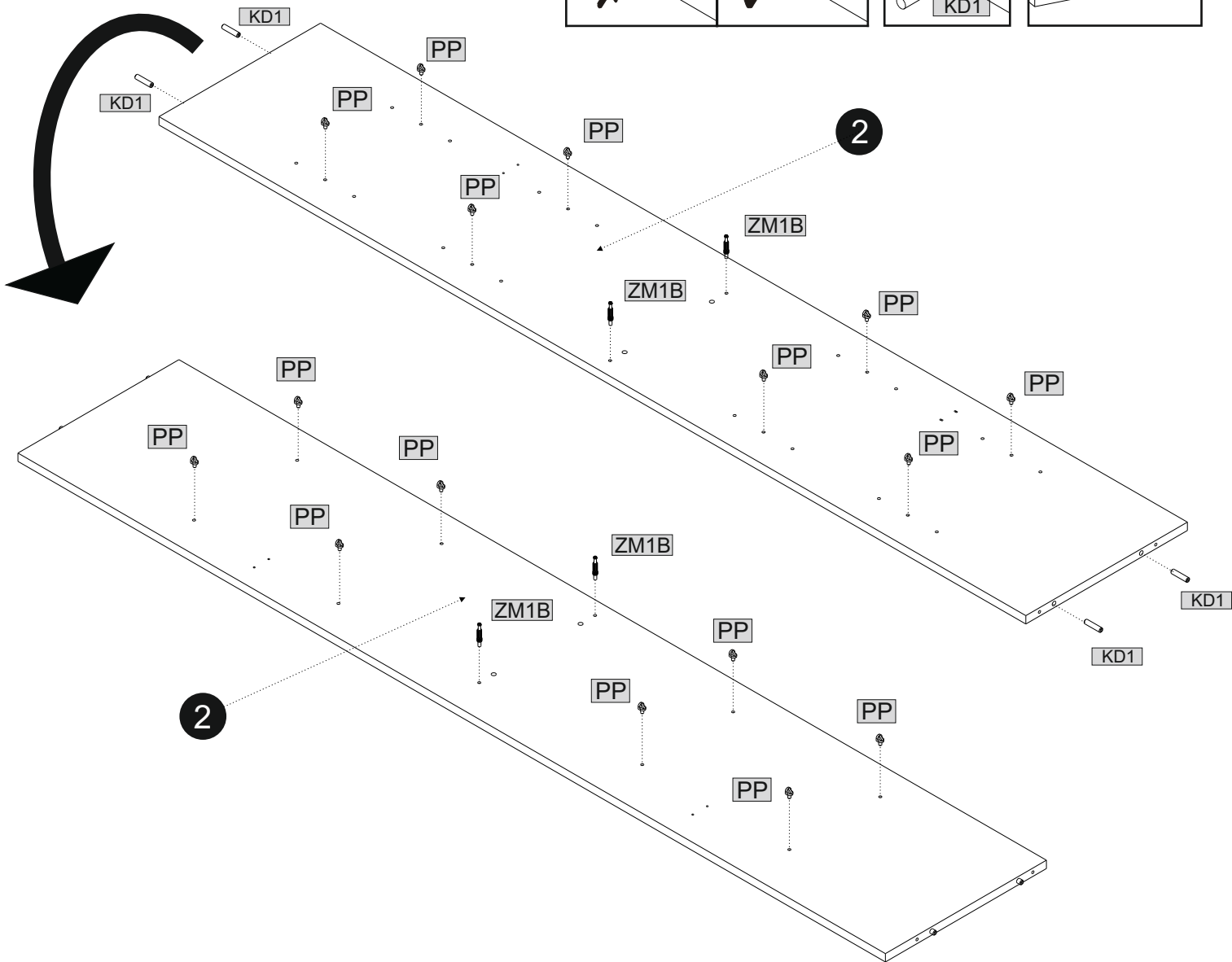
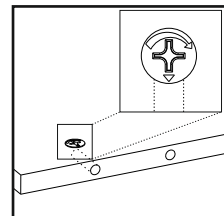
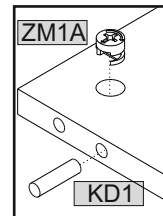
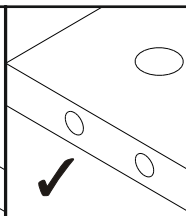
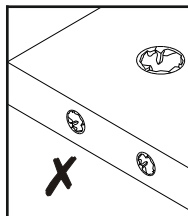

03

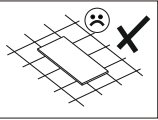
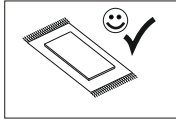

3,5x16		OK1	
W11	8	OK1	4

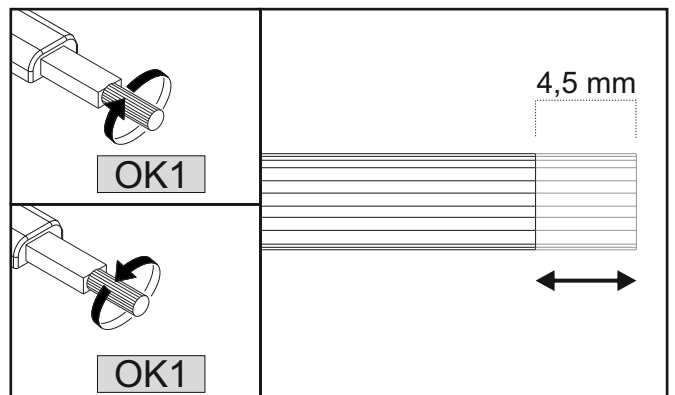
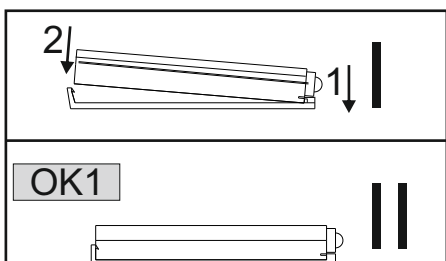
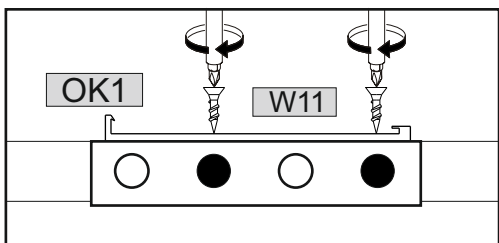
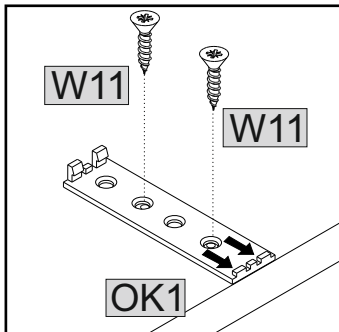
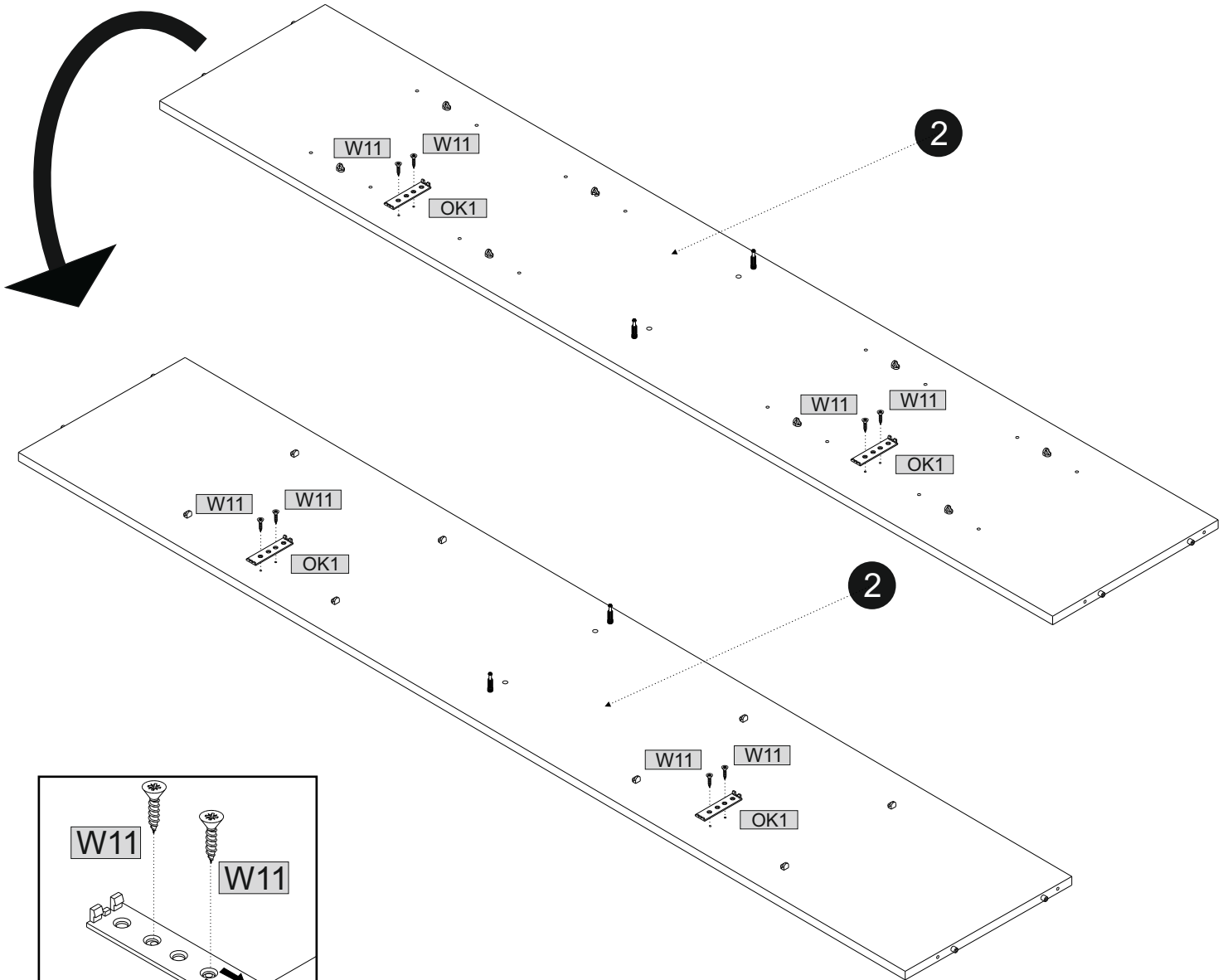

04

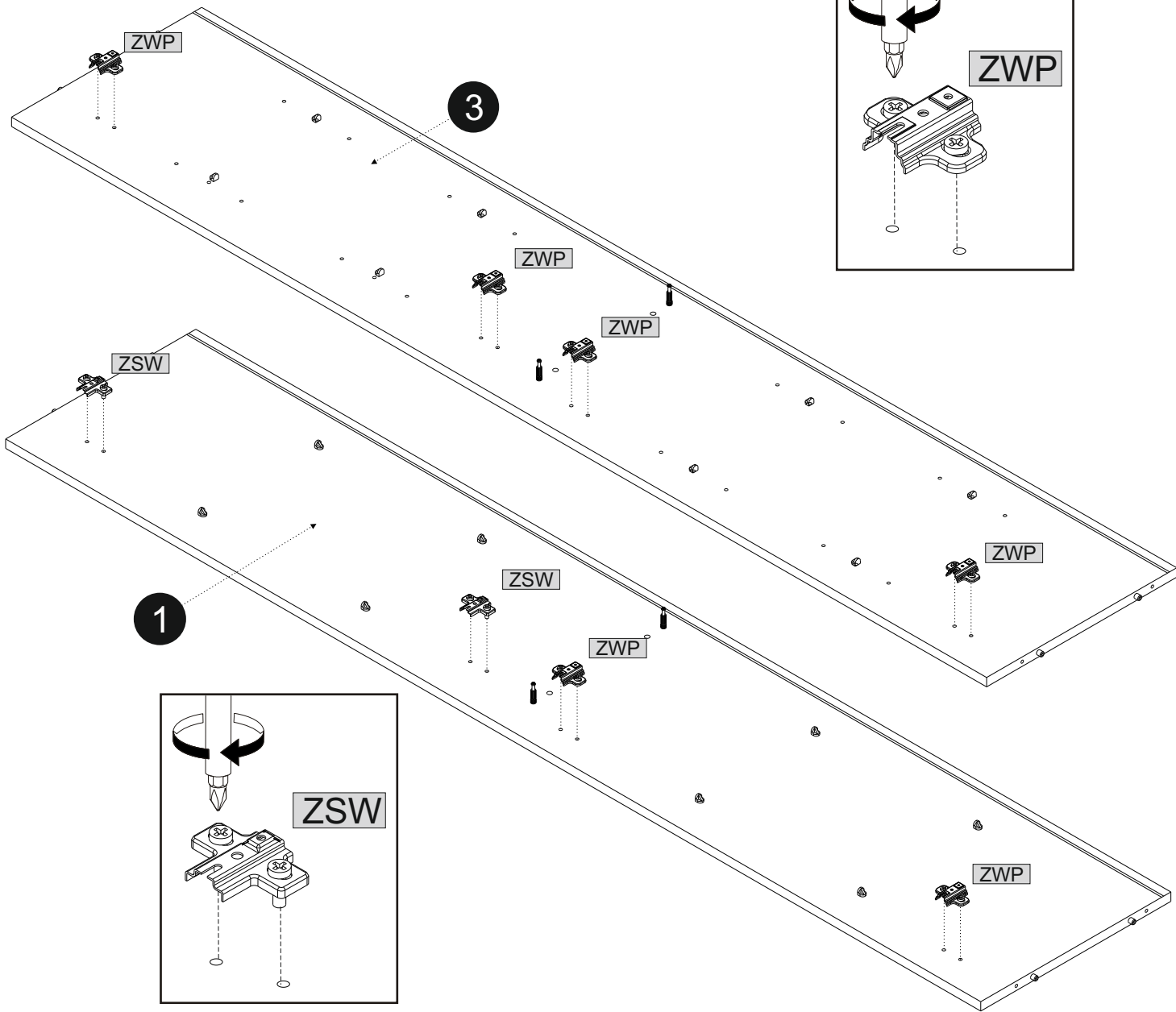
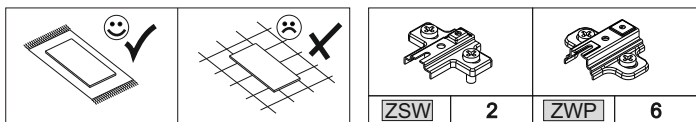

05

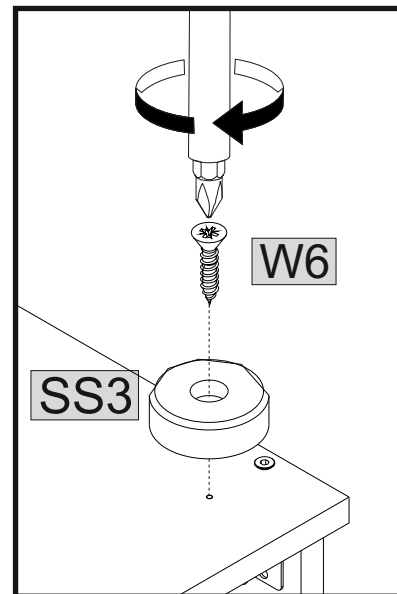
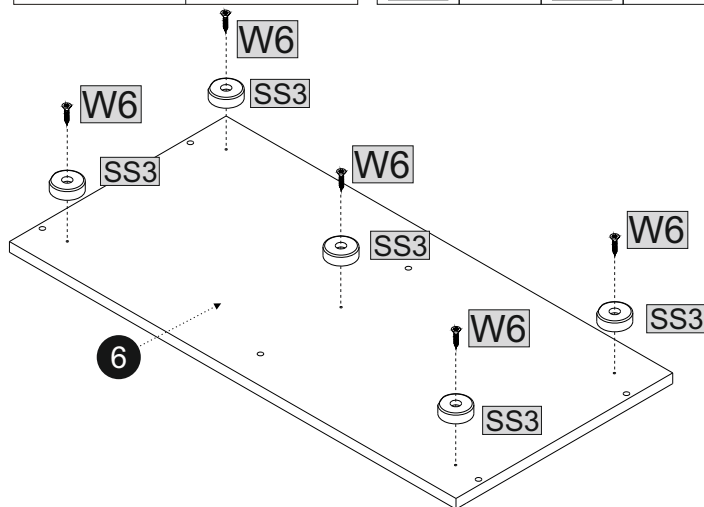
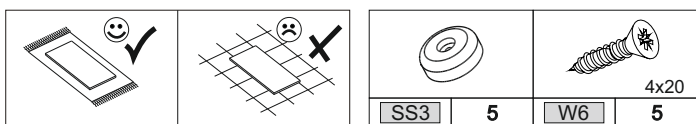

06

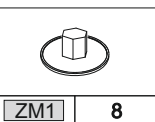
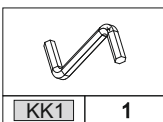
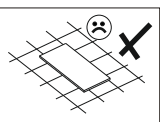
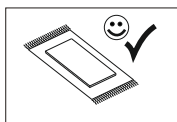

KK1	1	ZM1	8
-----	---	-----	---

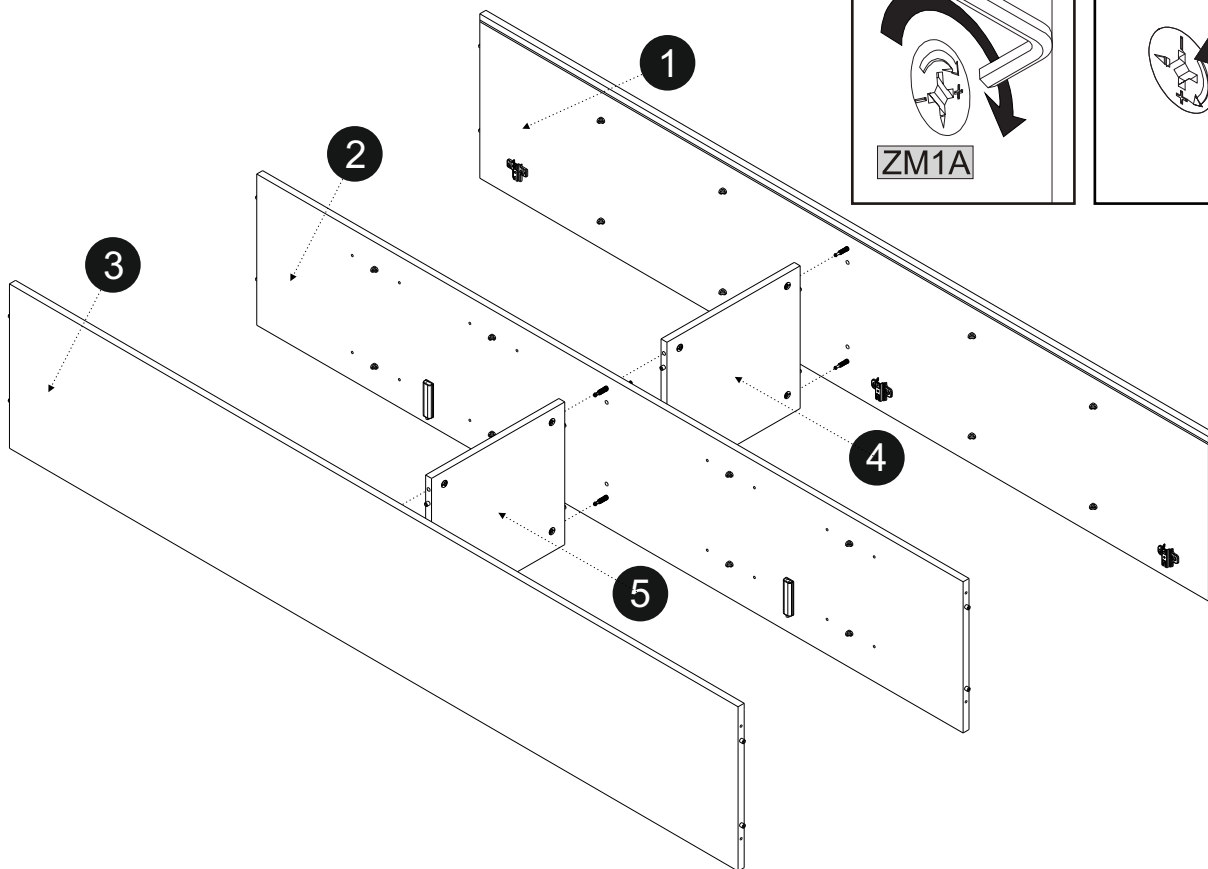
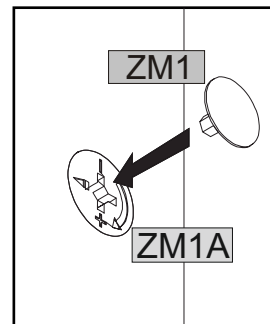
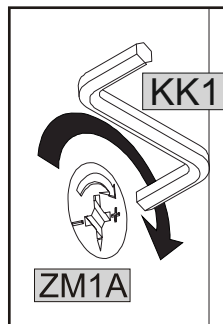

07

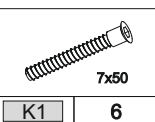
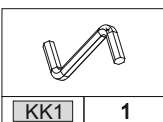
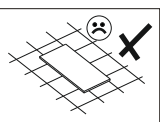
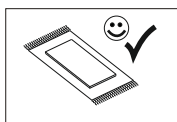

KK1	1	K1	6
-----	---	----	---

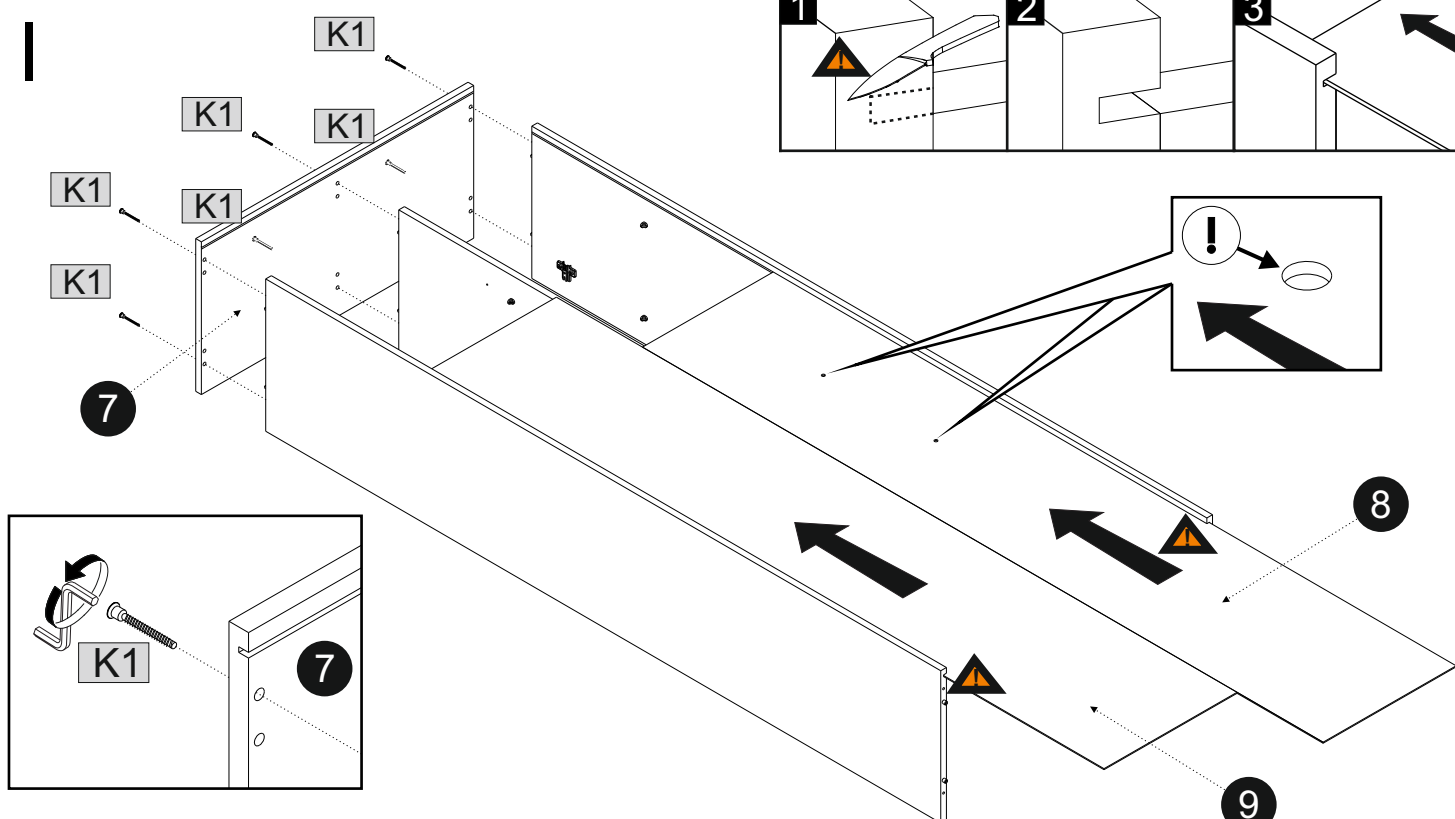
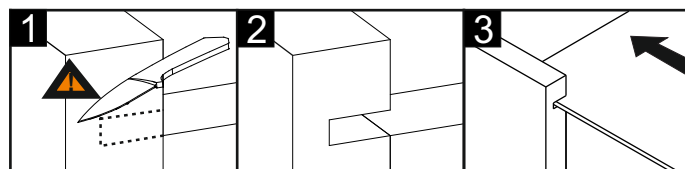

08

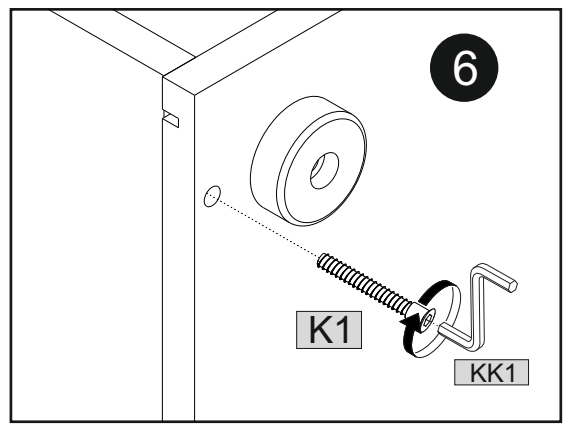
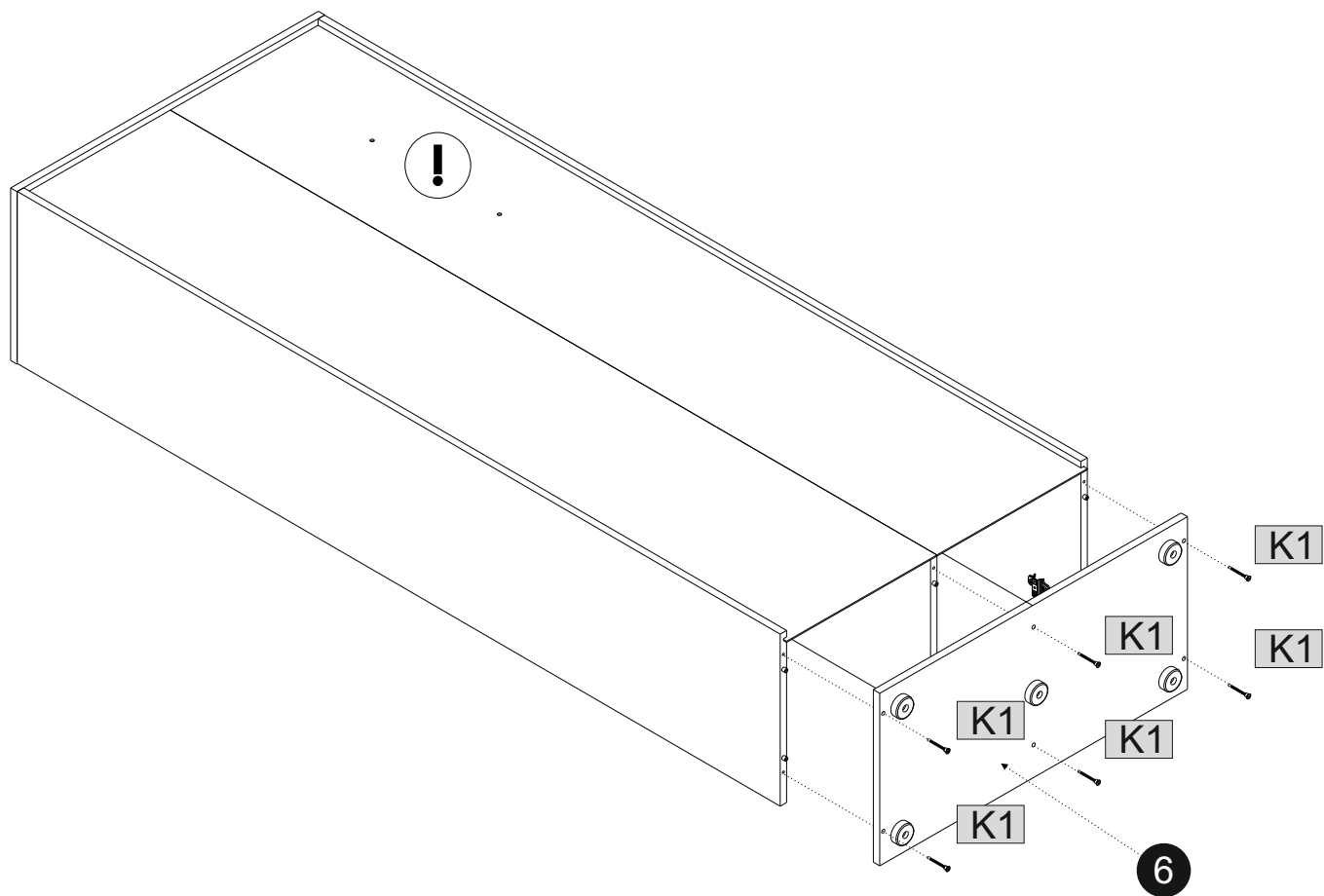
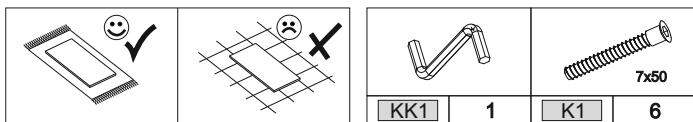

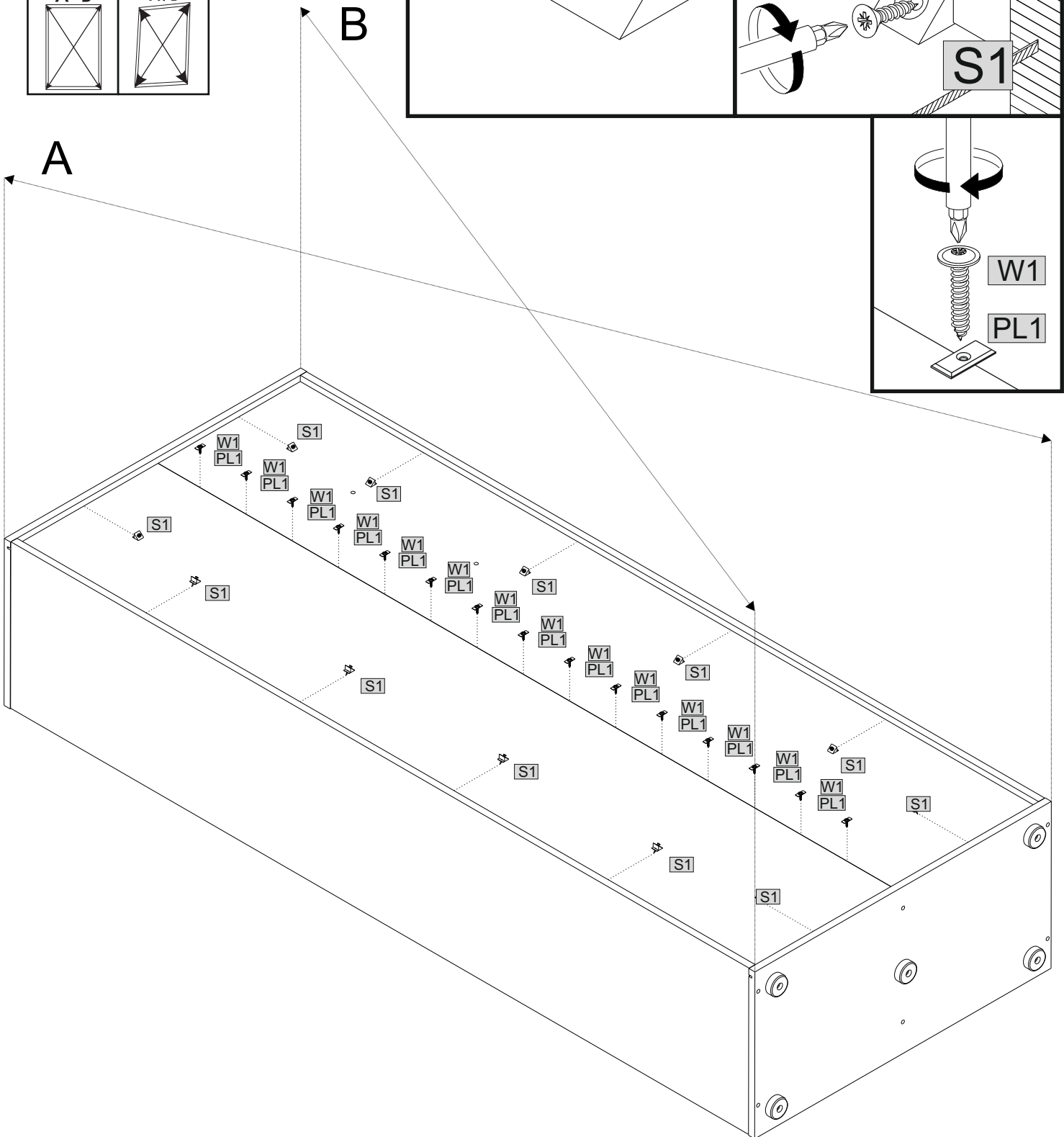
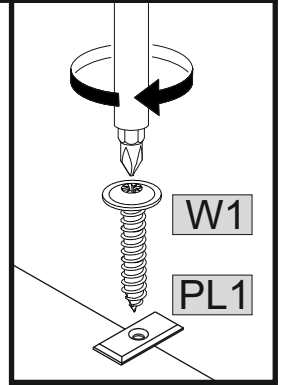
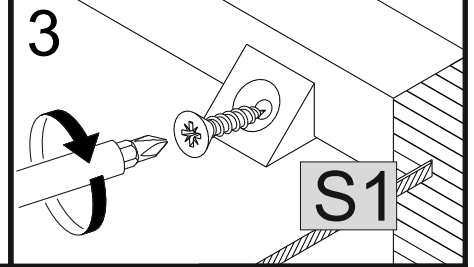
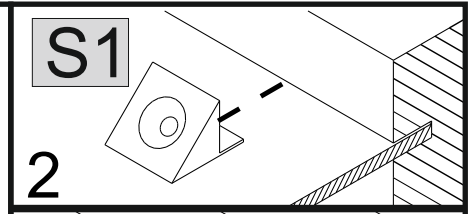
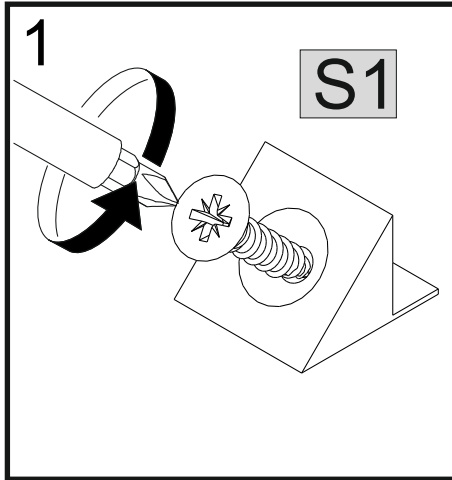
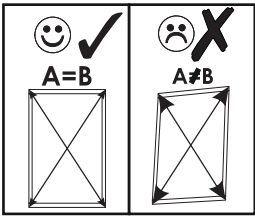
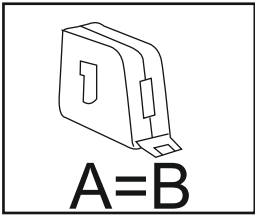

09

					3x16
S1	12	PL1	15	W1	15

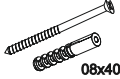

10

		
KS1	3,5x16	08x40
1	2	1

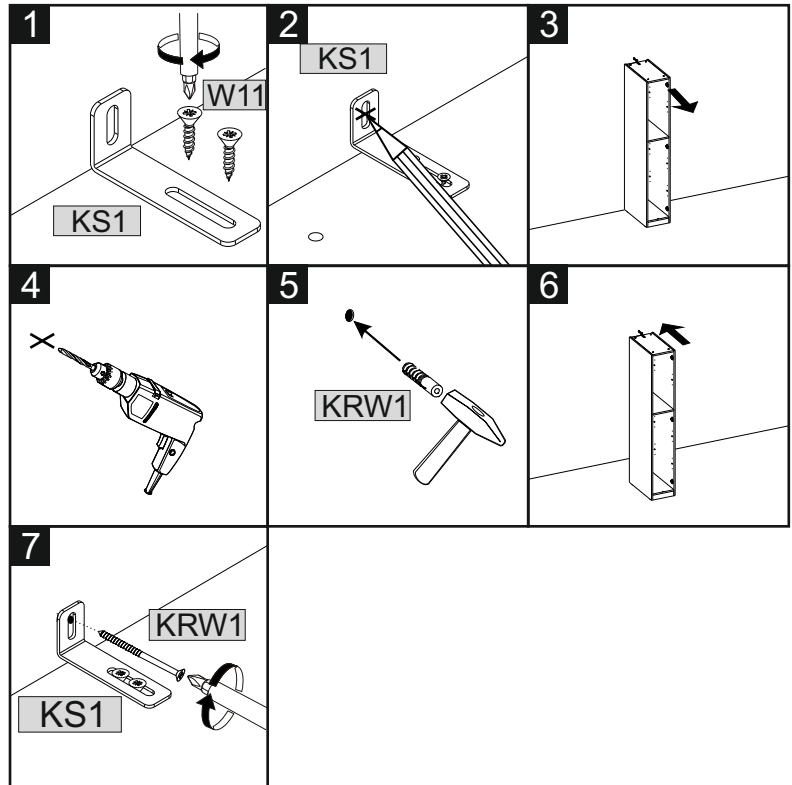
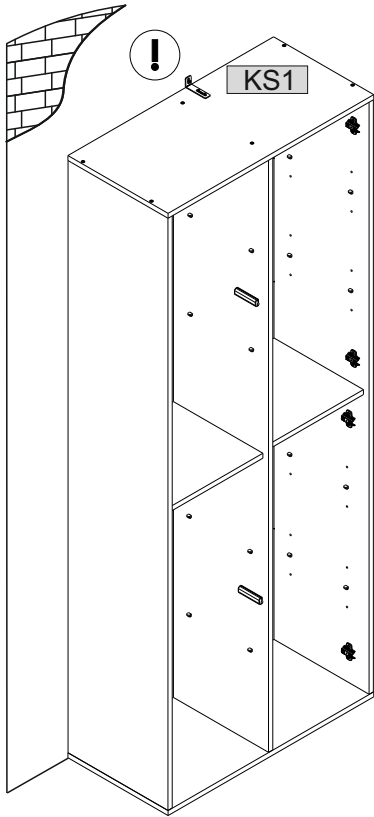

11

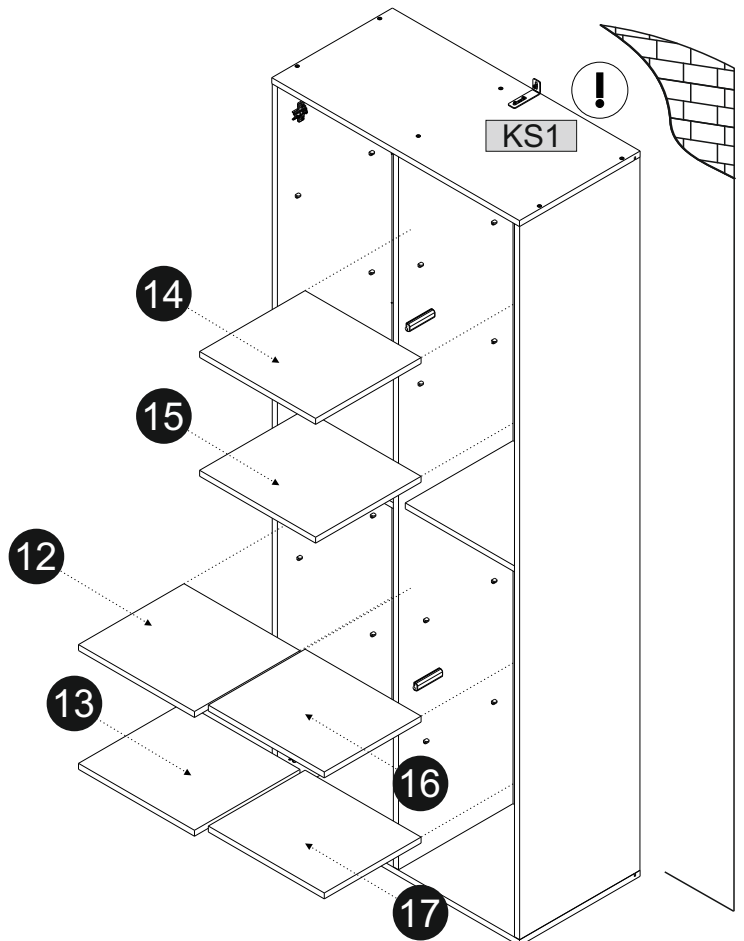
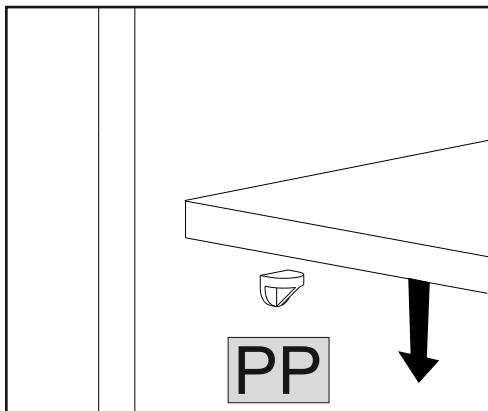

12

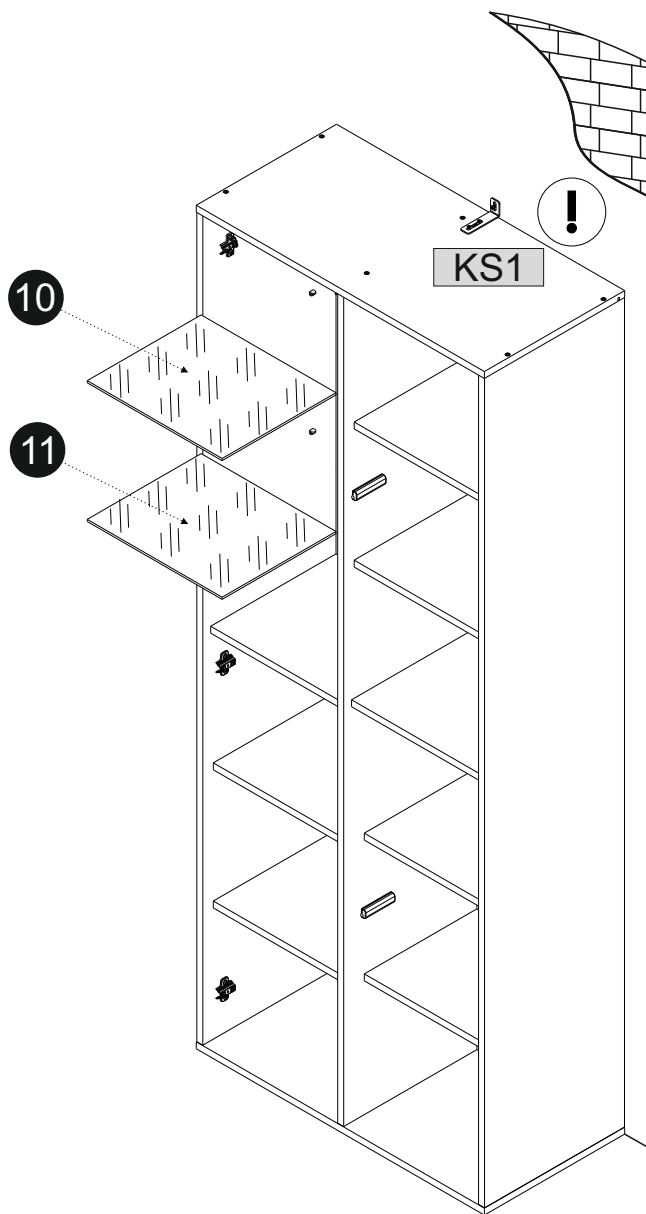
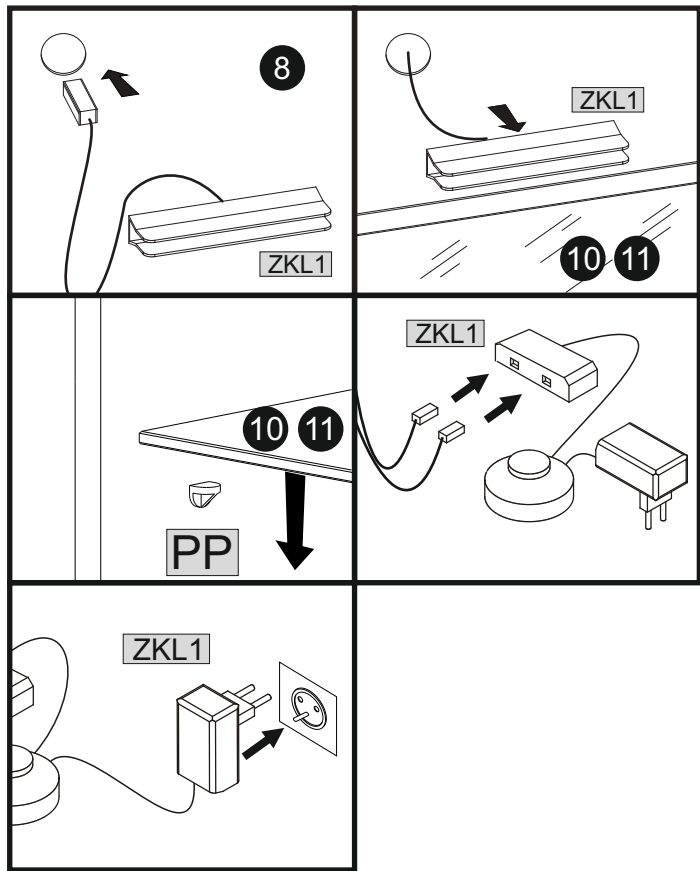
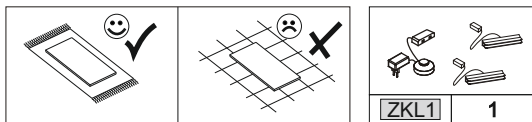

13

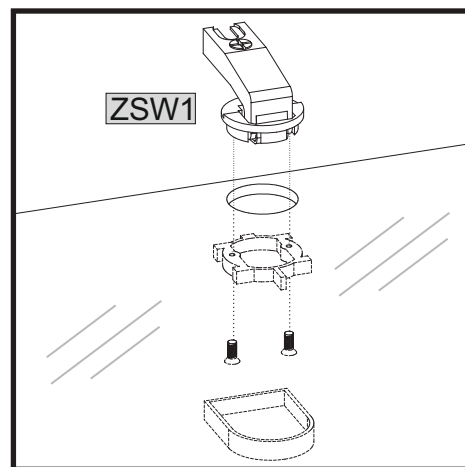
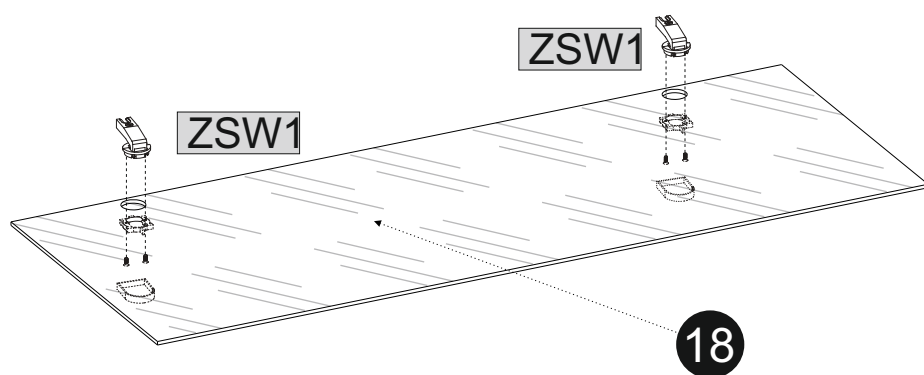
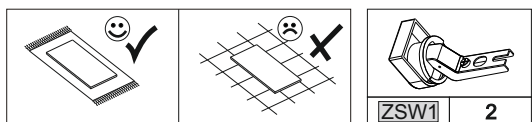

14

ZWP	6	W4	12

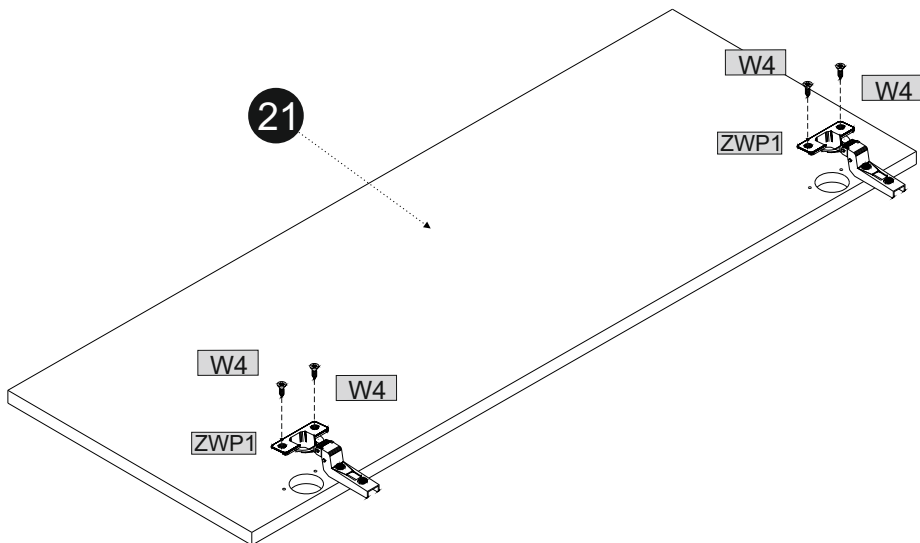
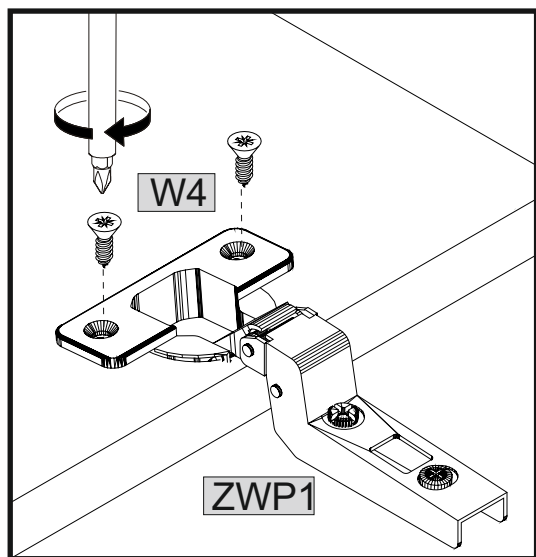
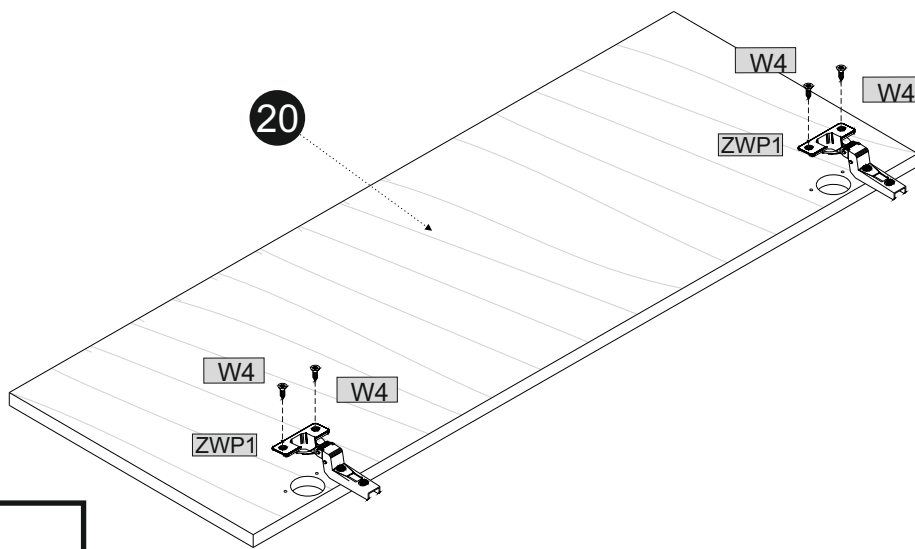
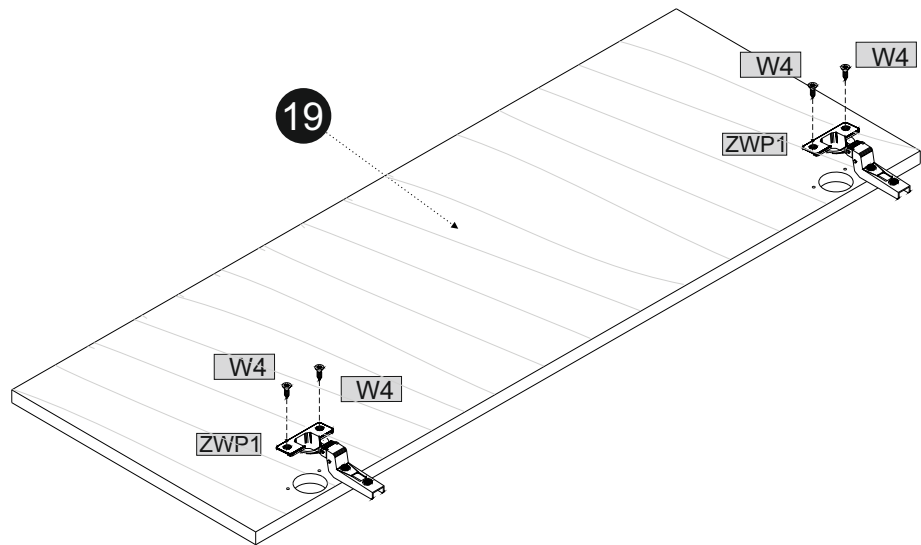

15

