

TORONTO RTV

MEBLE-OKMED DEMKO
Jesteśmy razem 30 lat!

„MEBLE-OKMED” DEMKO - SPÓŁKA JAWNA
 ul. Kolejowa 13, 14-500 Braniewo, POLSKA
www.mebleokmed.pl (+48) 55 243 27 26
firma@mebleokmed.pl

SERIA: .../...

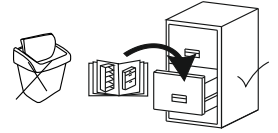

TORONTO RTV .../...
 Front: DAB_WARMIA
 Korpus: CZARNY / DAB_WARMIA
 MEBLE OKMED Demko SP J.
 14-500 Braniewo, Ul. Kolejowa 13

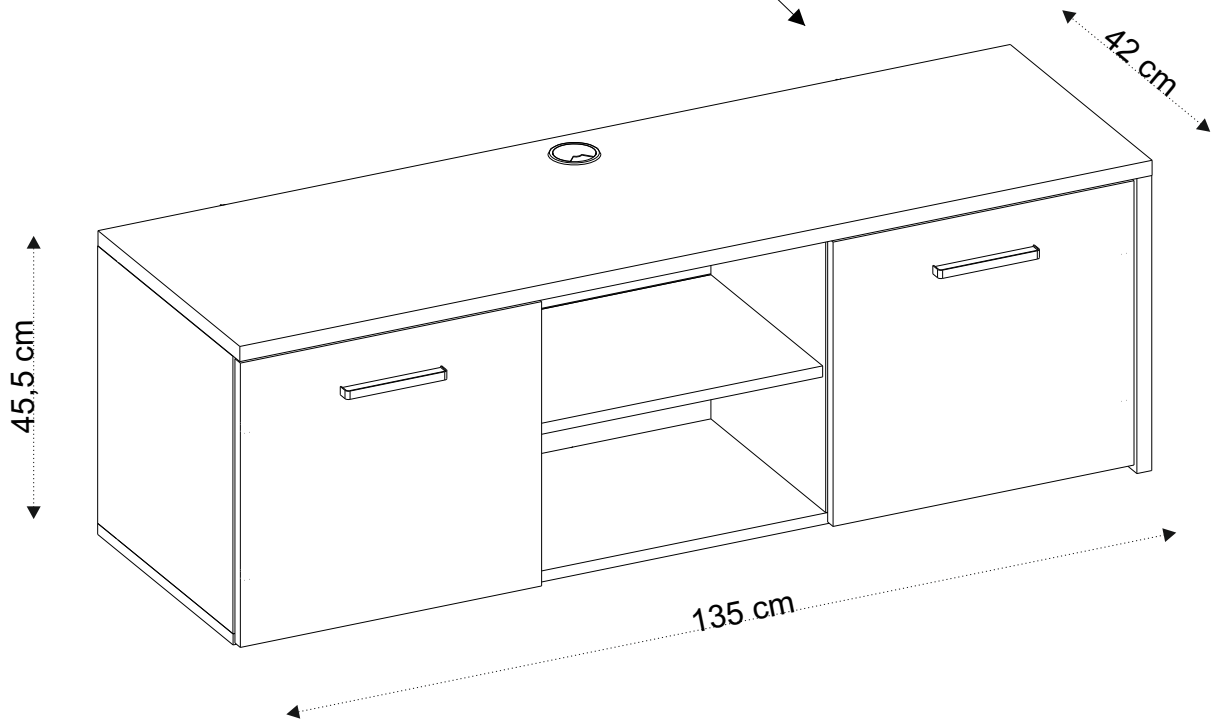
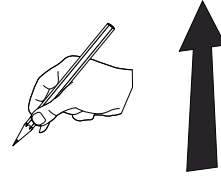





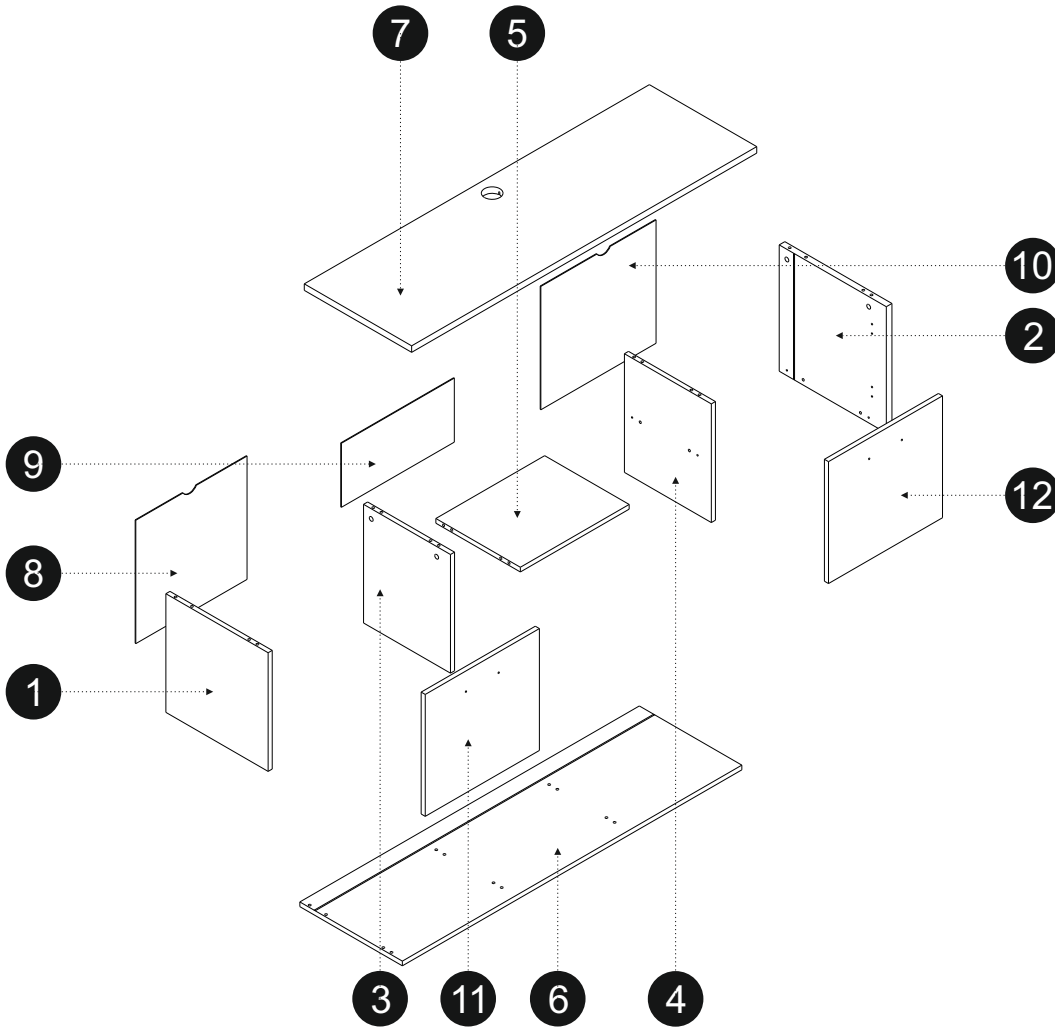



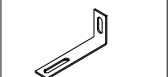
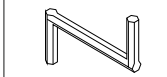
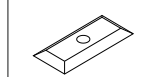
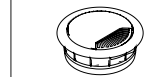

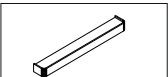
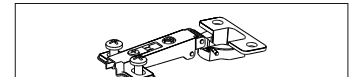
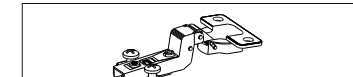
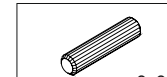

<p>Ø8 Ø4</p>								

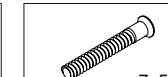
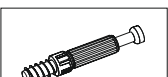
TORONTO RTV

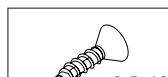

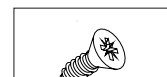
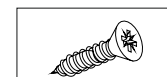
1/1				
	[mm]	[mm]	[mm]	
1	400	402	16	x1
2	428	419	22	x1
3	402	340	16	x1
4	402	340	16	x1
5	425	331	16	x1
6	1328	401	16	x1
7	1350	420	22	x1
8	434	418	3	x1
9	441	217	3	x1
10	450	418	3	x1
11	446	413	16	x1
12	446	413	16	x1

							
KS1 2	KK1 1	PL1 4	PK3 1	S1 7	SS3 4	SG2 2	ZM1 12
							
U61 2	ZP 2	Z1P 2	ZP 2	ZWP1 2	KD1 20	KRW1 2	K1 6
							
ZM1B 14	ZM1A 14	W11 4	W1 11	W4 8	W6 4	WU 4	

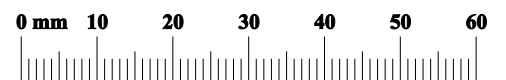

01

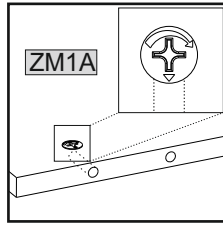
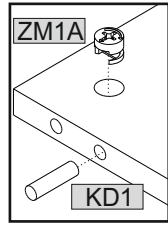
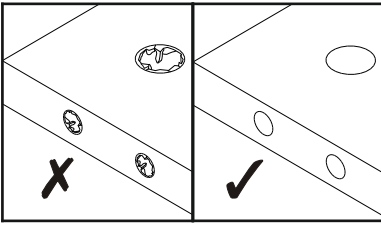



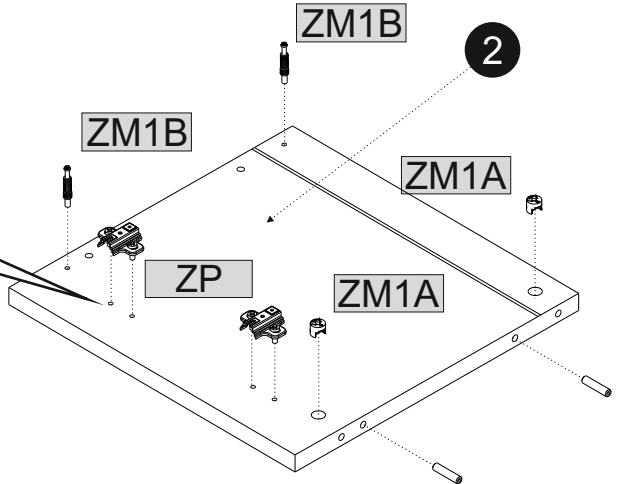
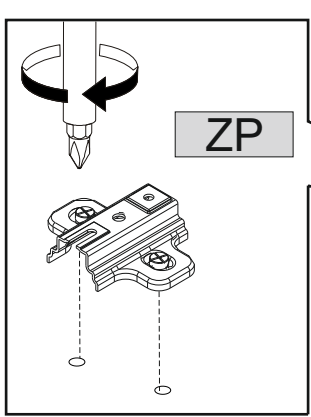
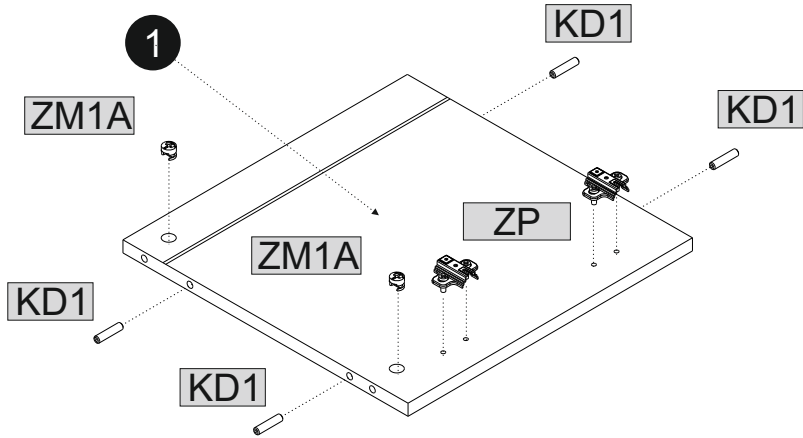
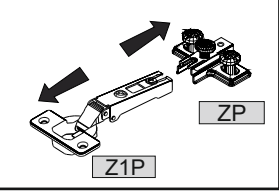
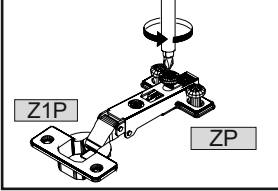
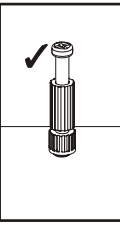
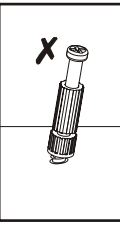
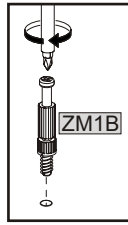
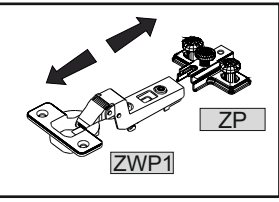
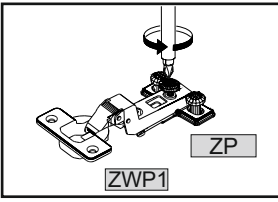

8x35		ZP	
KD1	6	ZP	4
ZM1B		15x15	
ZM1B	2	ZM1A	4

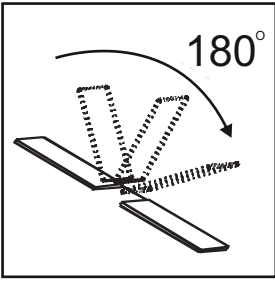

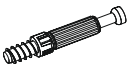
02



	
ZM1B	4
ZM1A	4
	
KD1	8

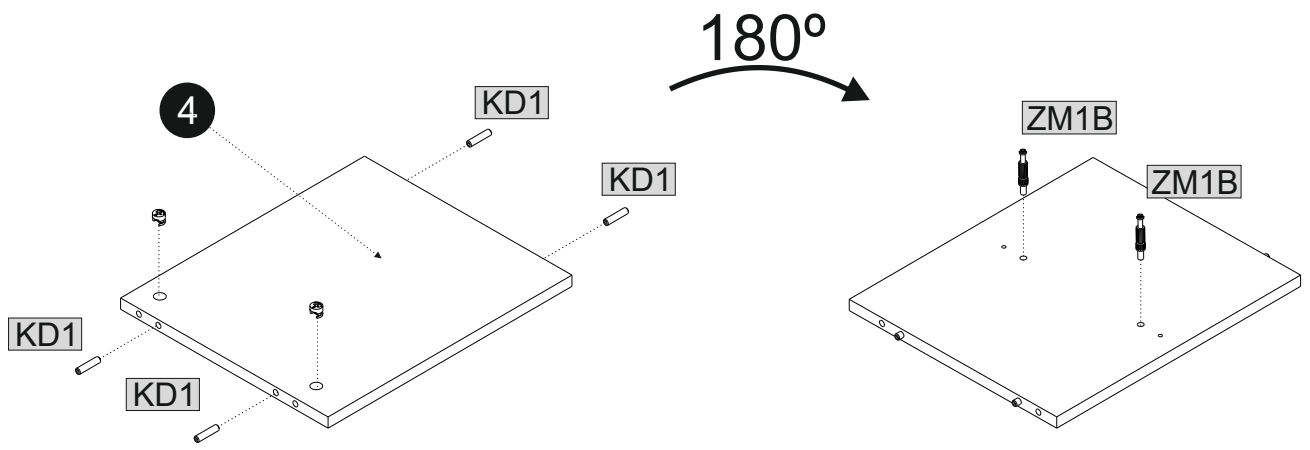
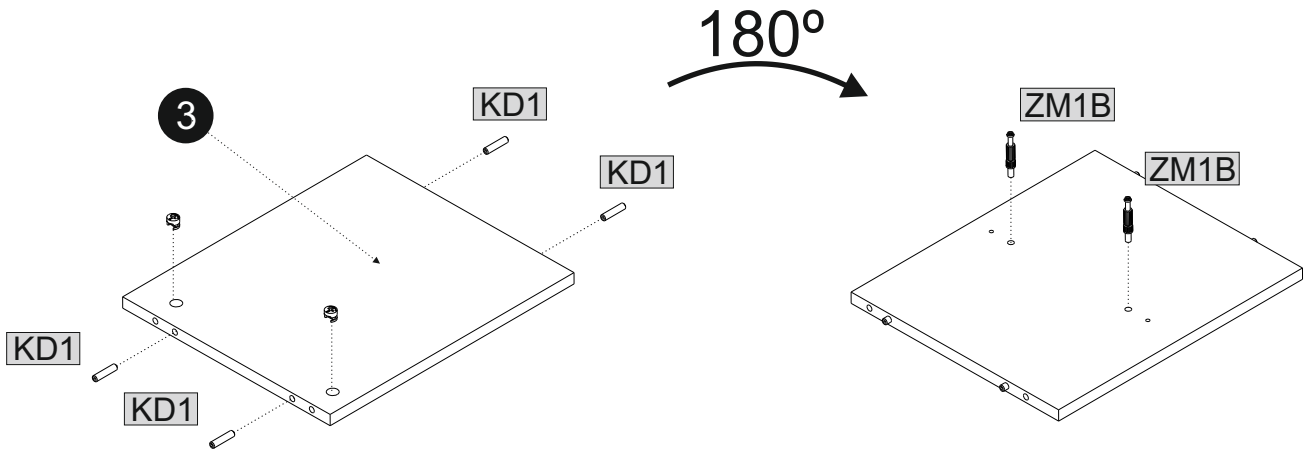

04

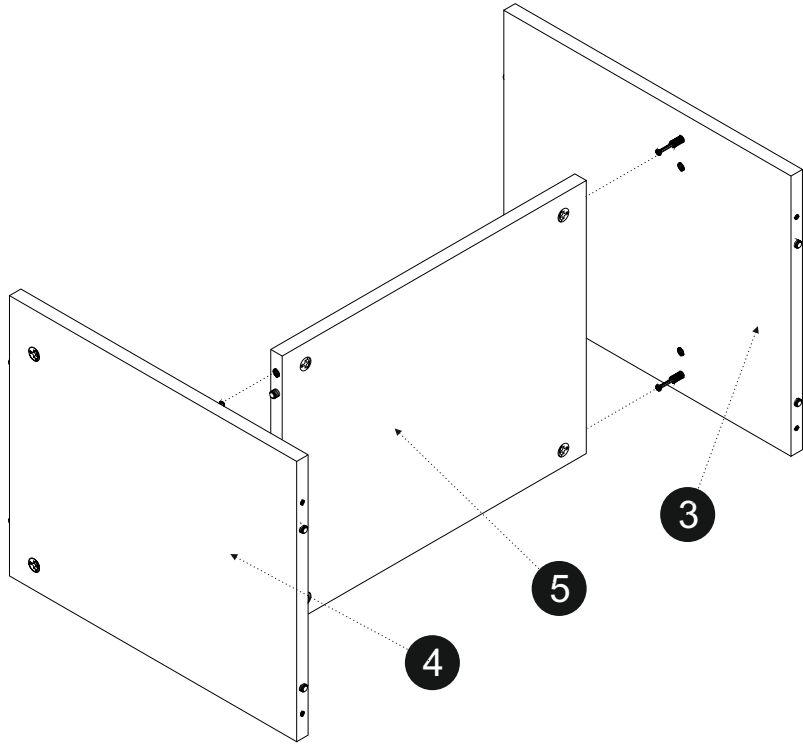
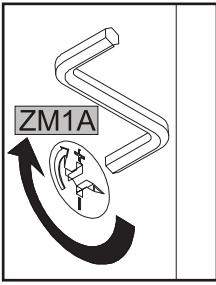

05

			7x50
KK1	1	K1	6

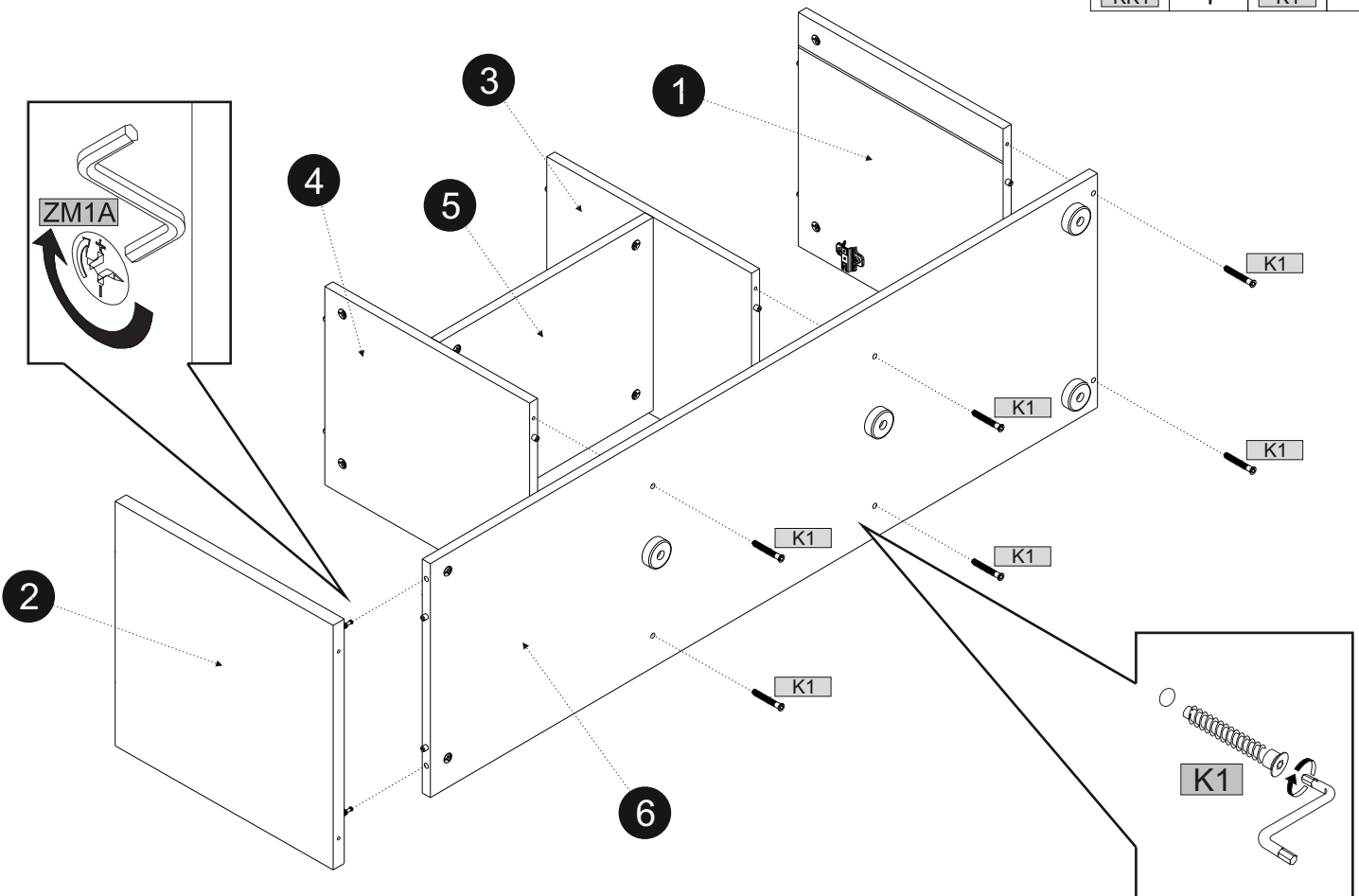

06

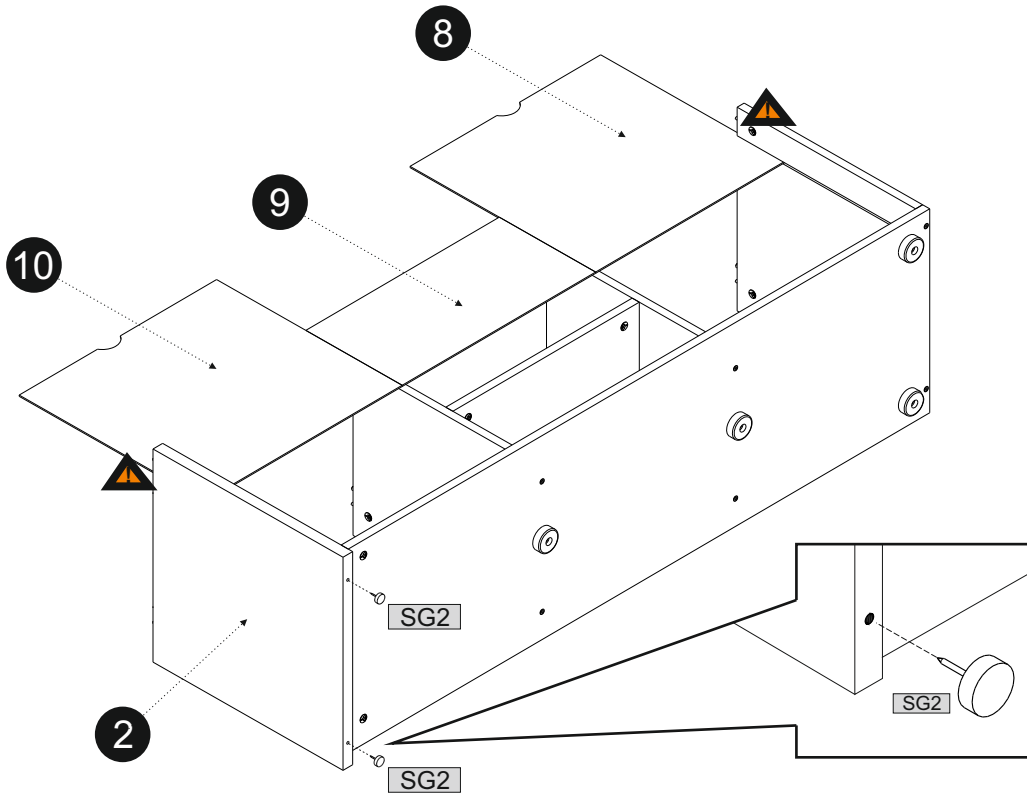
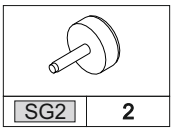
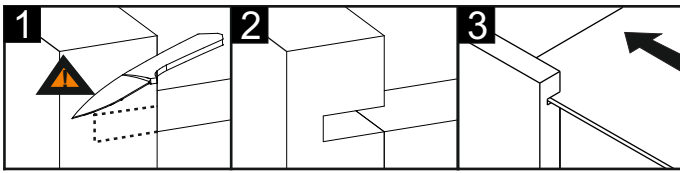

07

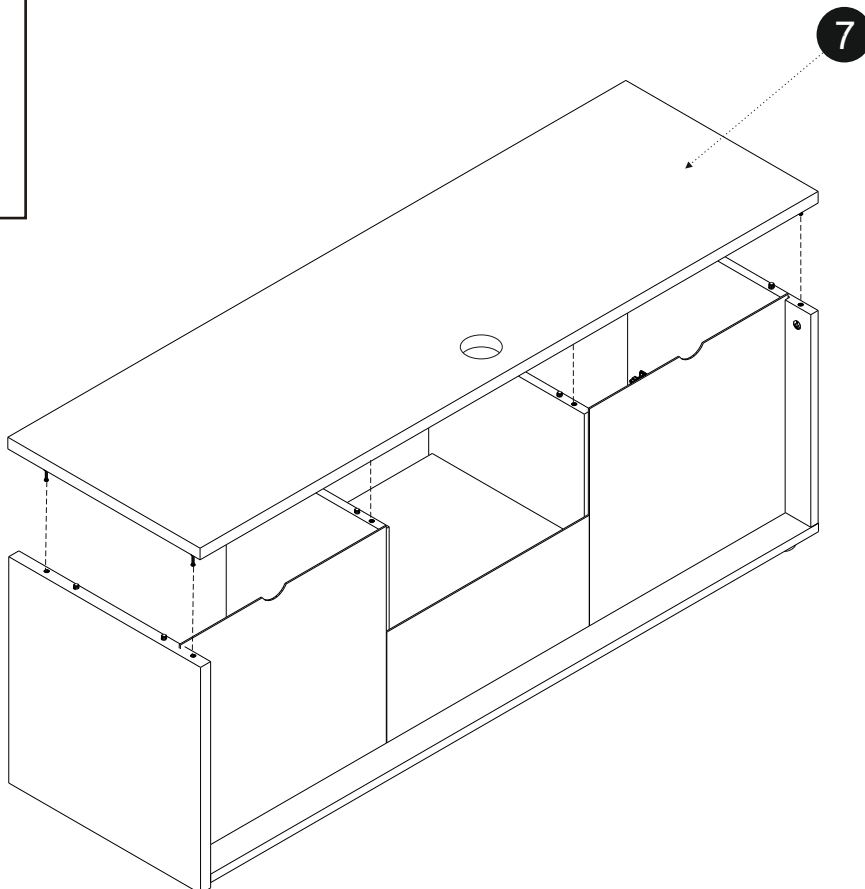
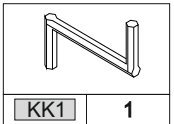
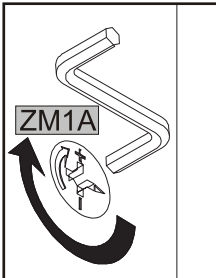

08

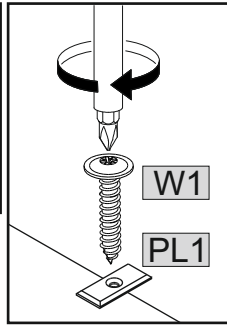
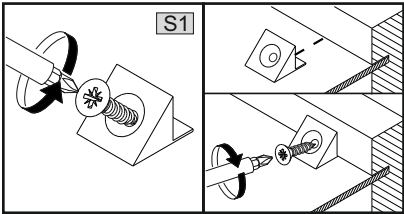

	7
--	---

	4
--	---

	11
--	----

3x16

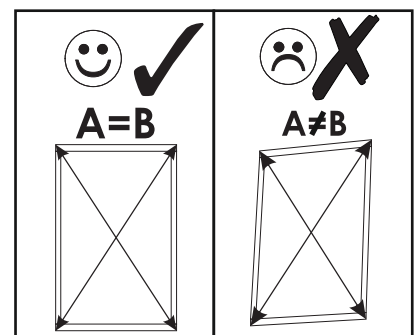
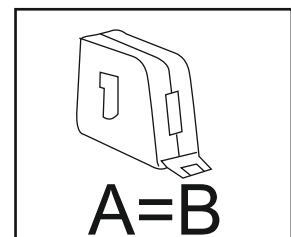
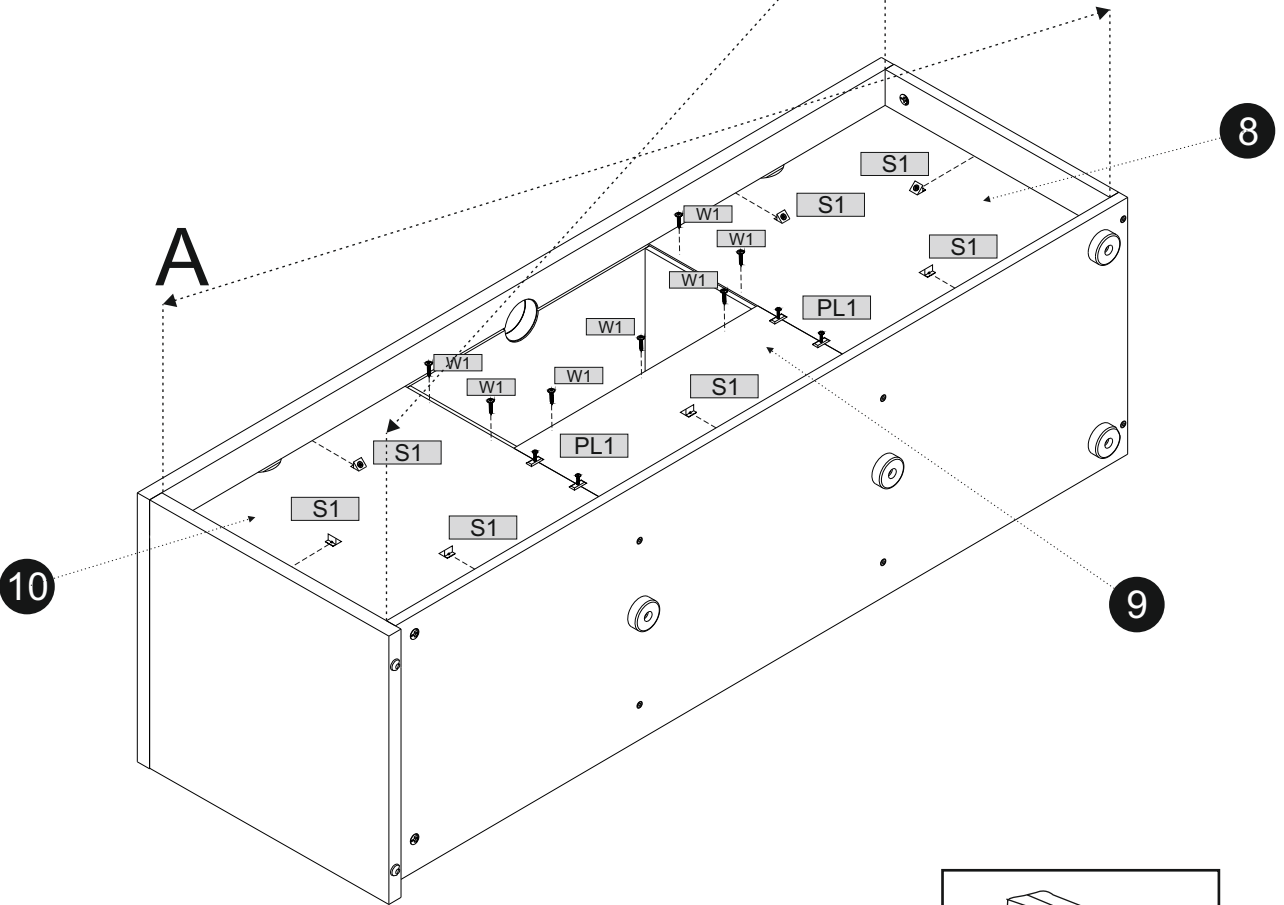
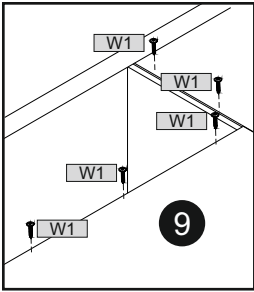

09

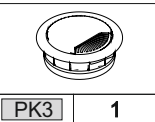
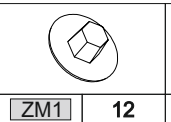
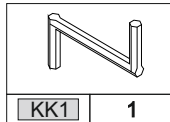
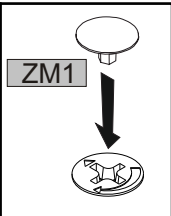
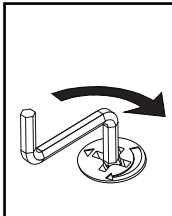
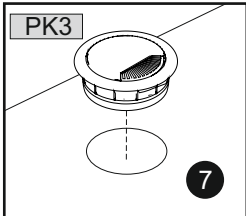

KK1	1	ZM1	12	PK3	1
-----	---	-----	----	-----	---

7

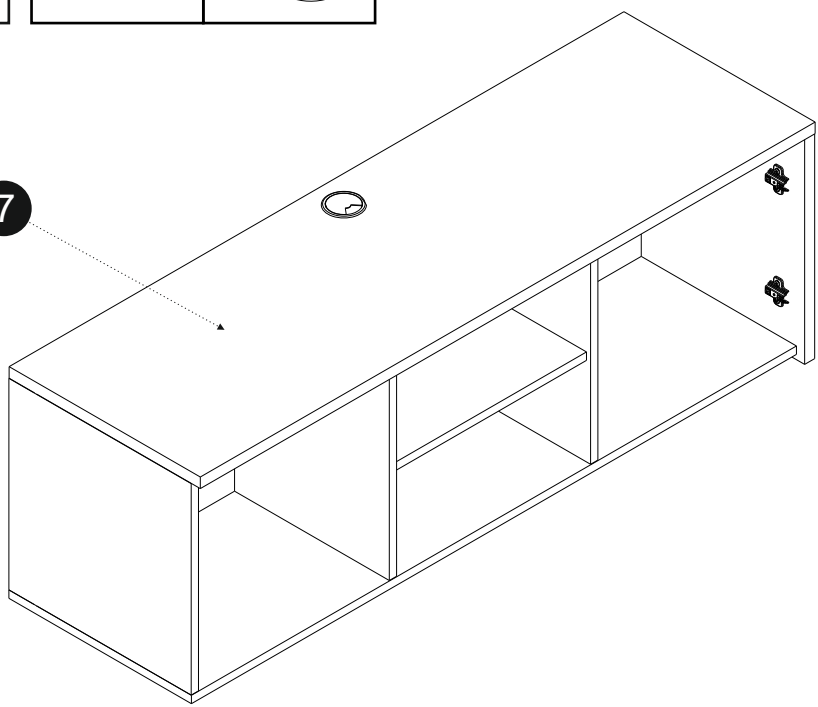

10

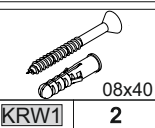
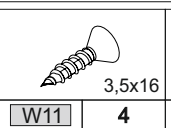
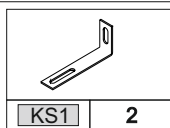

KS1	2	W11	4	KRW1	2
-----	---	-----	---	------	---

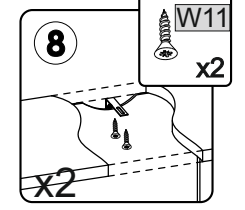
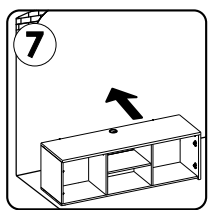
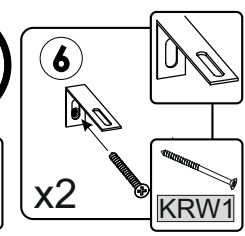
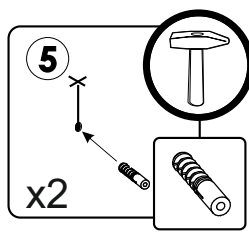
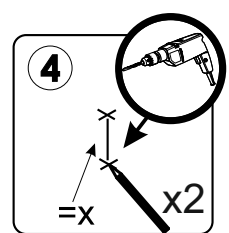
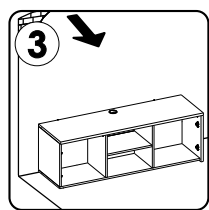
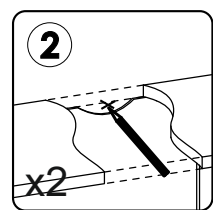
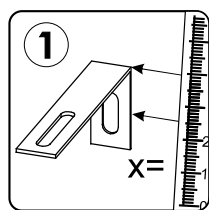
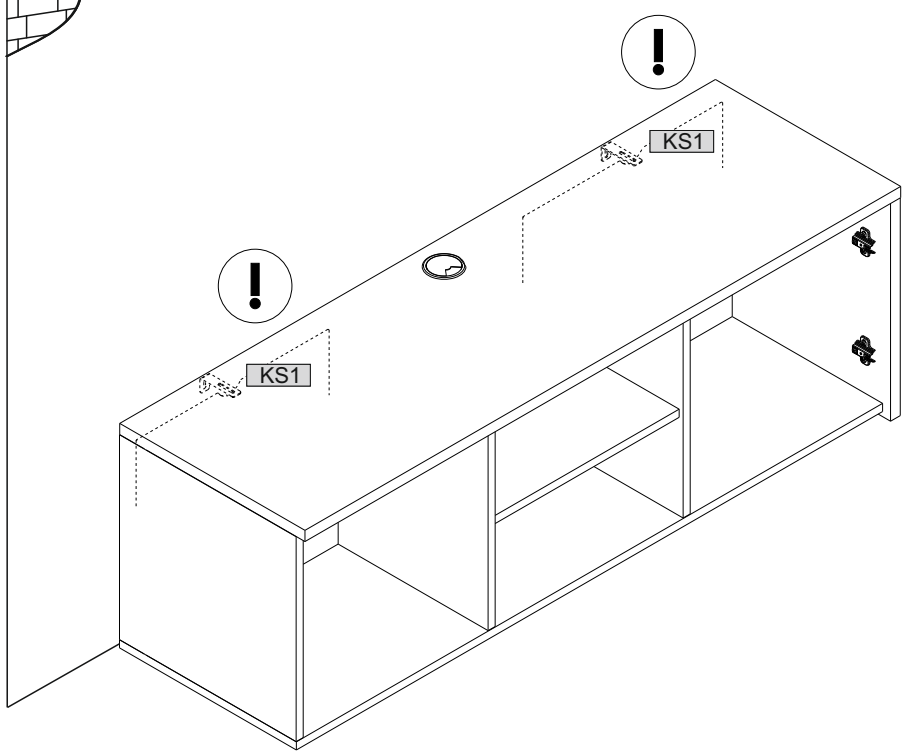
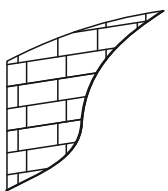

11

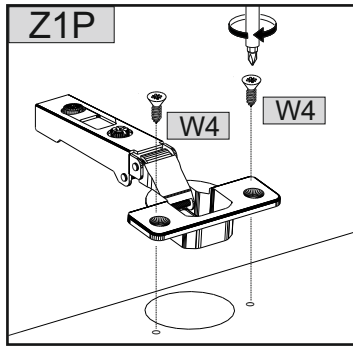
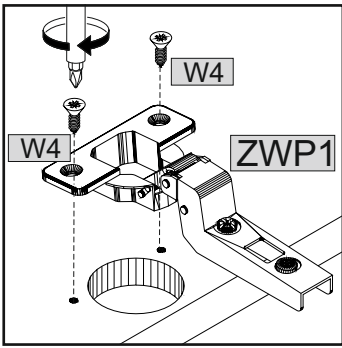

			4x13
Z1P	ZWP1	W4	
2	2	8	

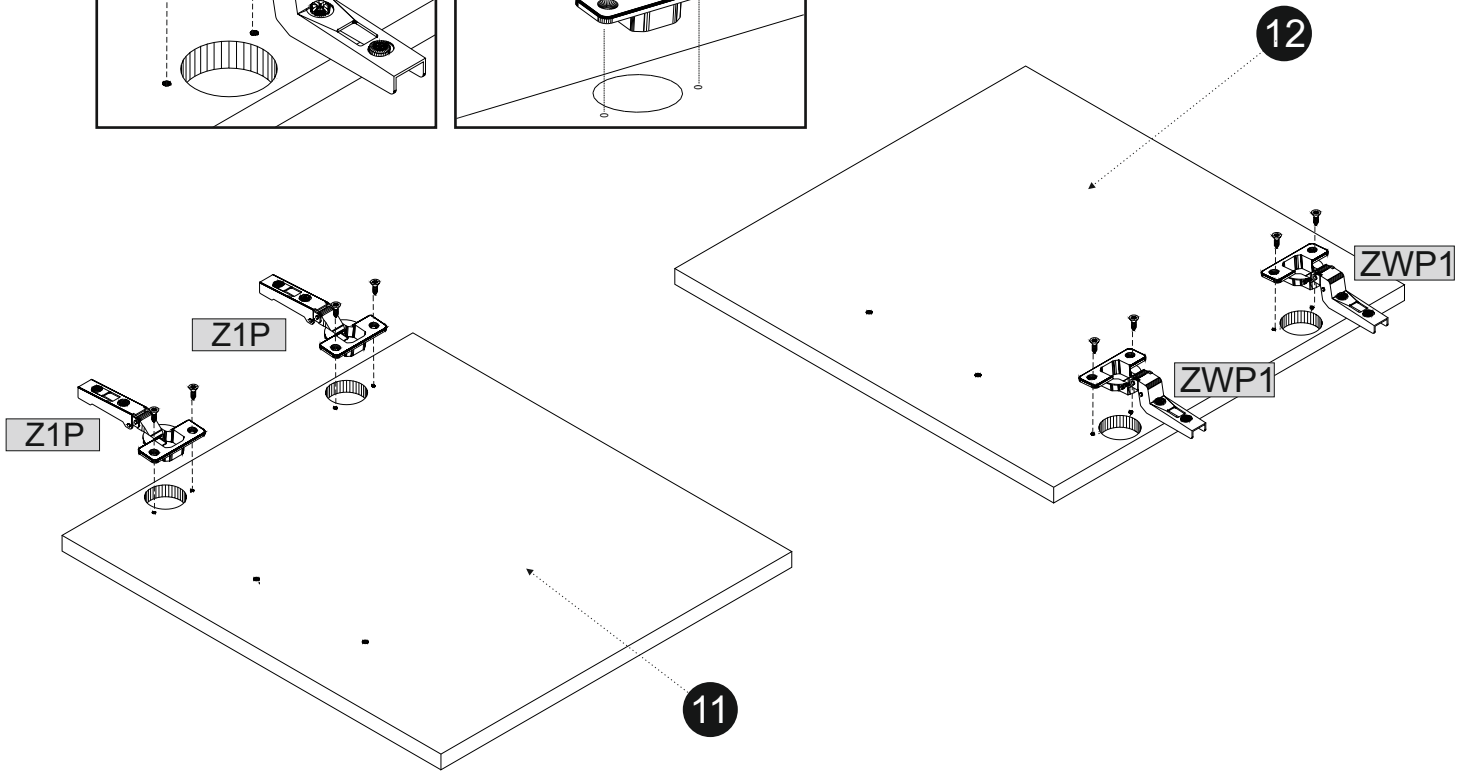

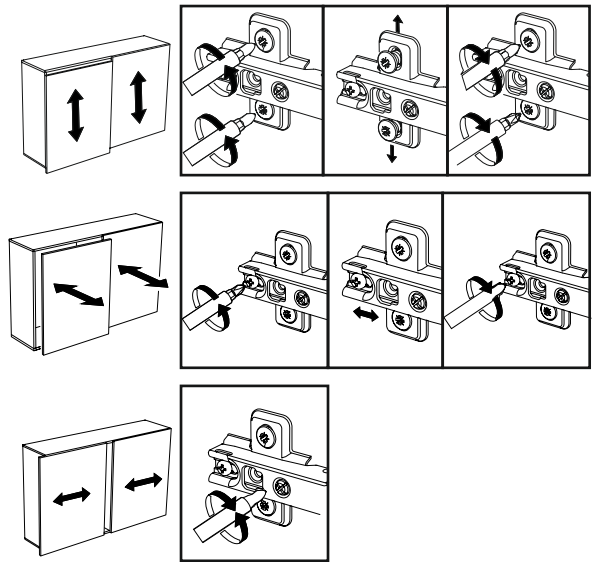
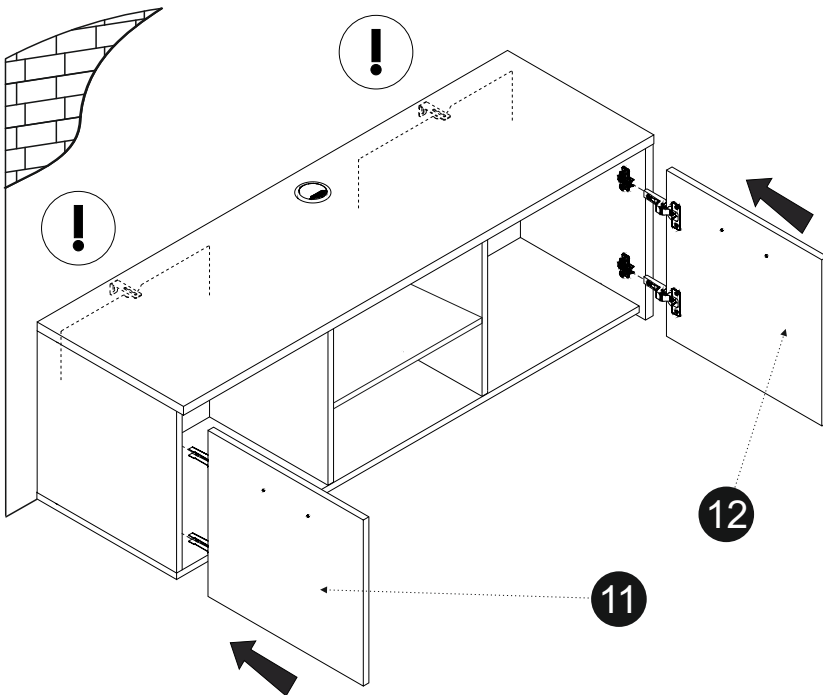
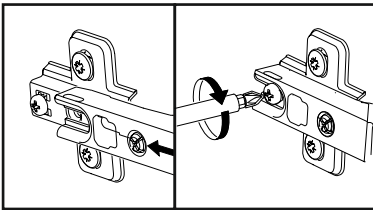

12

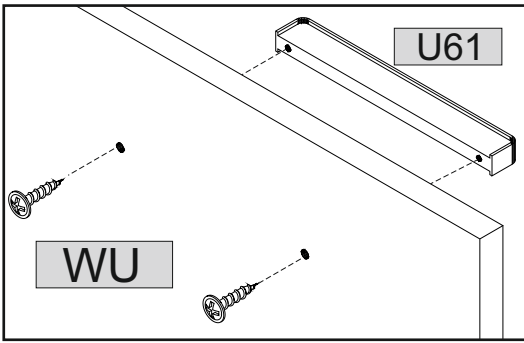

13



			4x30
U61	2	WU	4

