

TORONTO D 3D

MEBLE-OKMED DEMKO
Jesteśmy razem 30 lat!

„MEBLE-OKMED” DEMKO - SPÓŁKA JAWNA
 ul. Kolejowa 13, 14-500 Braniewo, POLSKA
www.mebleokmed.pl (+48) 55 243 27 26
firma@mebleokmed.pl

SERIA: .../...

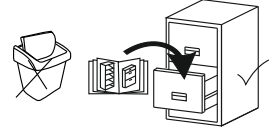

TORONTO Komoda 3D .../...
 Front: DAB_WARMIA
 Korpus: CZARNY / DAB WARMIA
 MEBLE OKMED Demko SP. J.
 14-500 Braniewo, Ul. Kolejowa 13
Jesteśmy razem 30 lat!

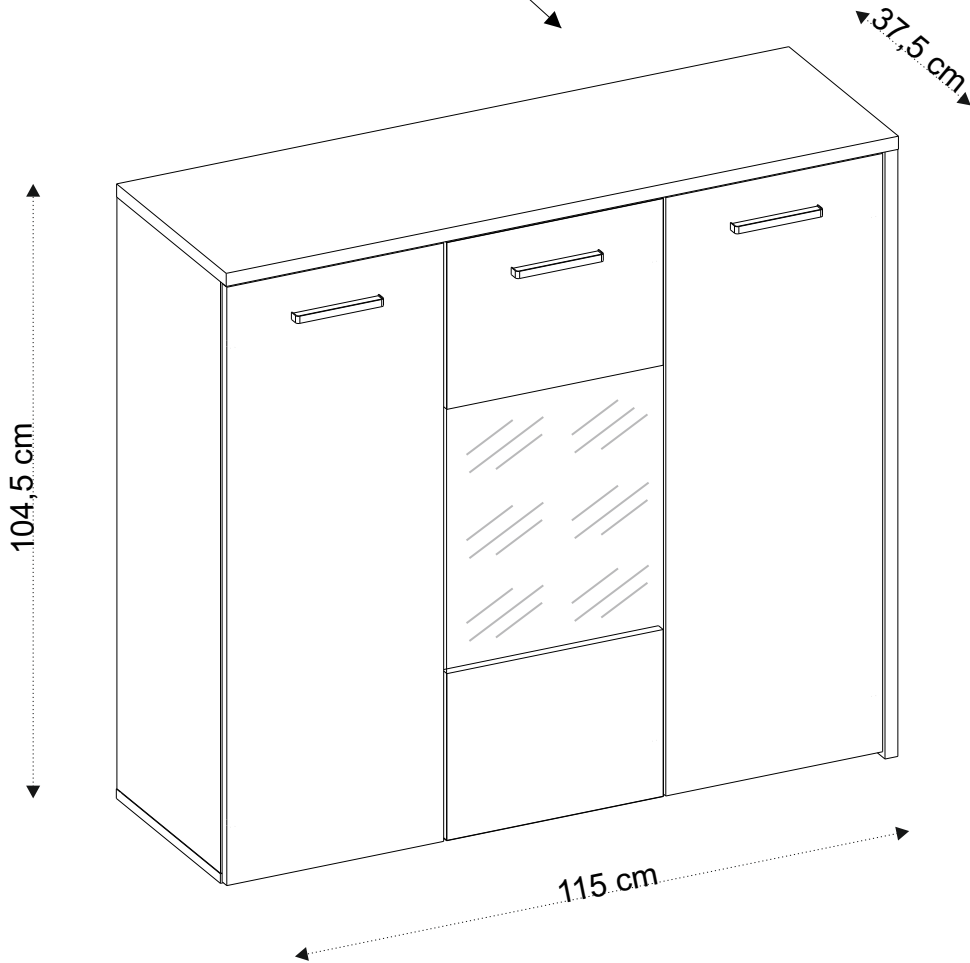
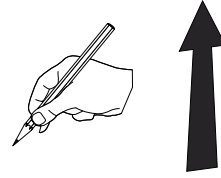

Ø8
Ø4

TORONTO D 3D



1/2

	[mm]	[mm]	[mm]	
1	992	355	16	x1
2	1018	374	22	x1
3	1128	356	16	x1
4	1150	375	22	x1
8	371	280	16	x1
9	503	353	4	x1
10	371	280	16	x1

2/2

	[mm]	[mm]	[mm]	
5	359	327	16	x2
6	1003	371	16	x1
7	1003	371	16	x1
11	992	337	16	x1
12	992	337	16	x1
13	1008	368	3	x1
14	1008	375	3	x1
15	1008	384	3	x1
16	352	328	16	x2
17	368	328	16	x2

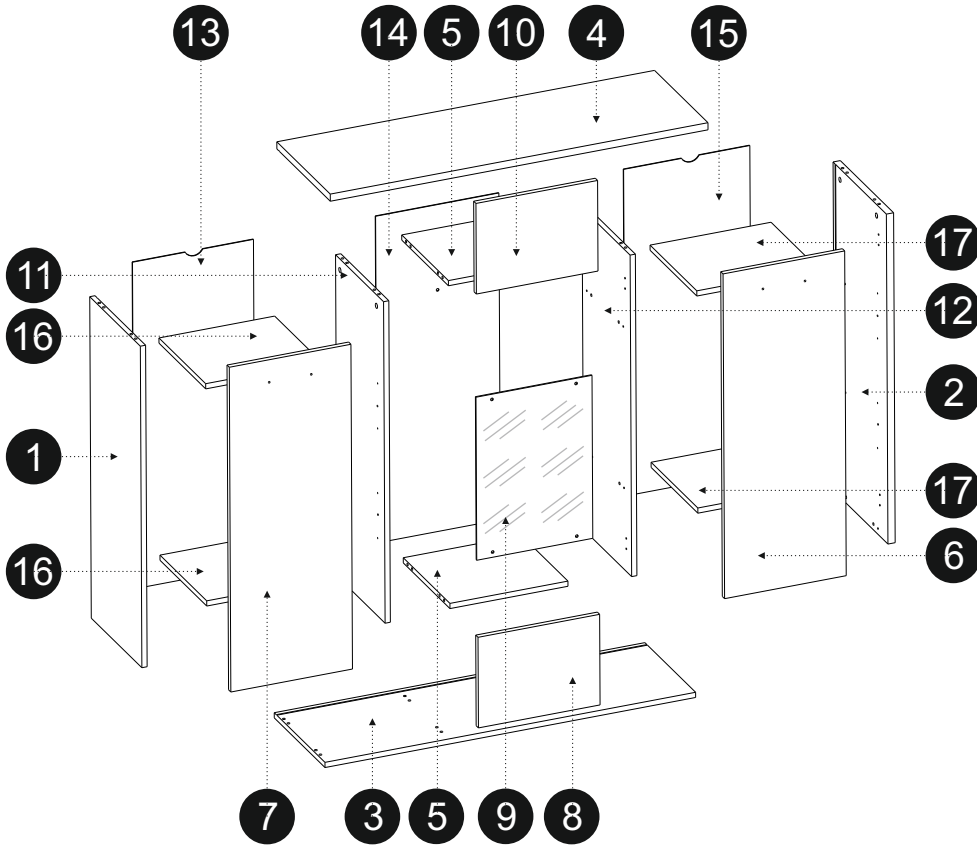

KS1 2	KK1 1	ZKL1 1	PL1 14	PP 16	S1 12	SS3 4	SG2 2
TS1 4	ZM1 16	ZP 2	Z1P 2	ZP 2	ZP1 2	ZP 2	ZWP1 2
U61 3	KD1 24 8x35	KRW1 2 08x40	K1 6 7x50	ZM1B 18	ZM1A 18 15x15	W11 4 3,5x16	W1 14 3x16
W4 12 4x13	W12 4 4x16	W6 4 4x20	WU 6 4x30				

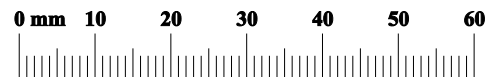

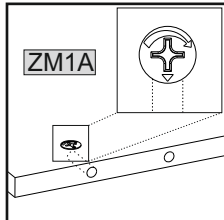
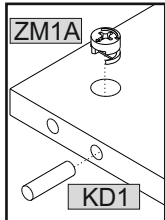
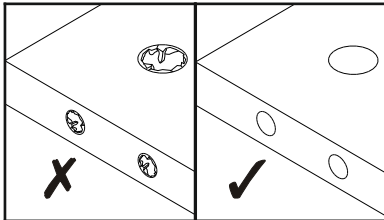

01

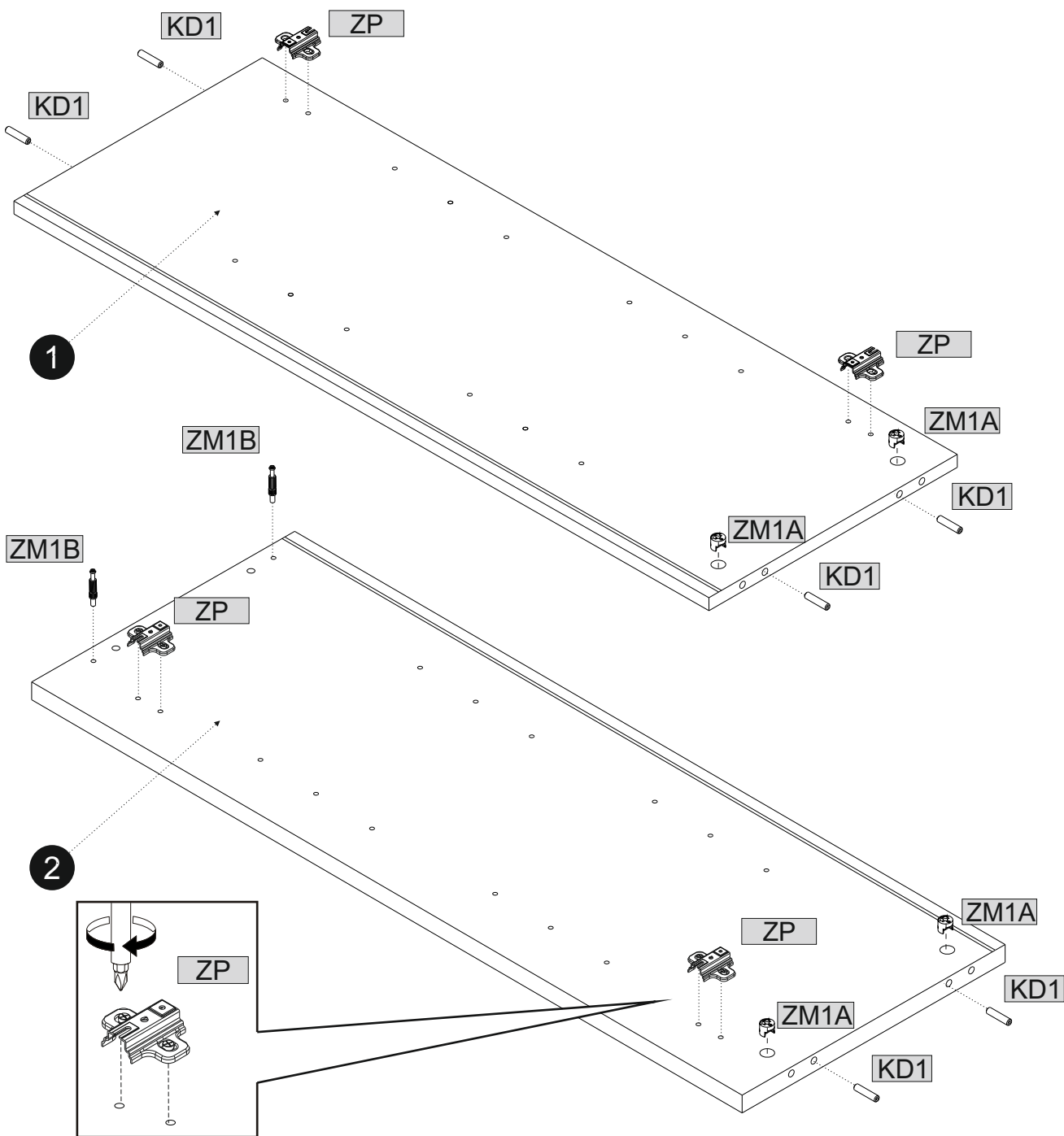
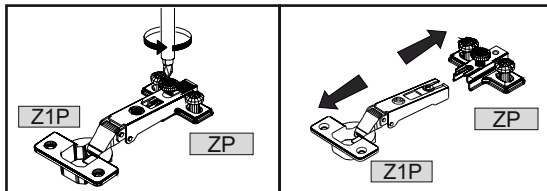
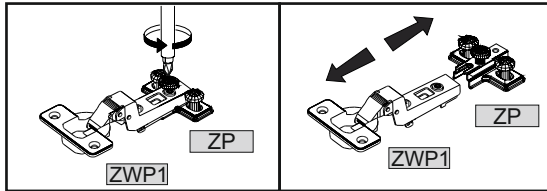
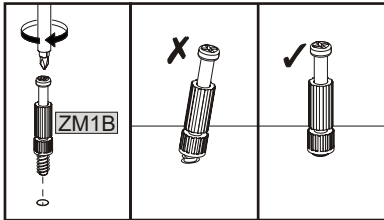

ZM1B	2	ZP	4
	8x35		15x15
KD1	6	ZM1A	4



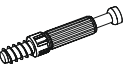

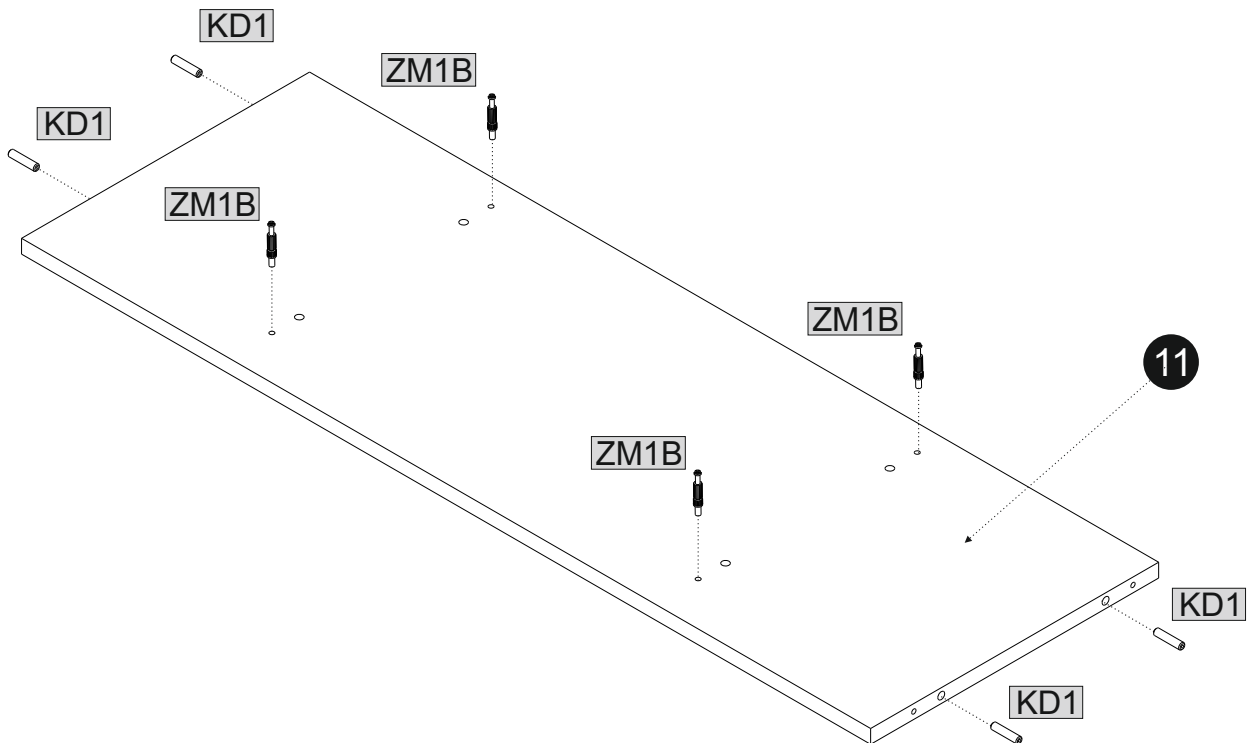
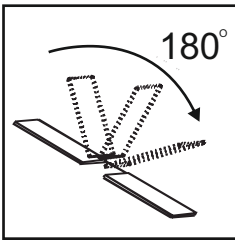
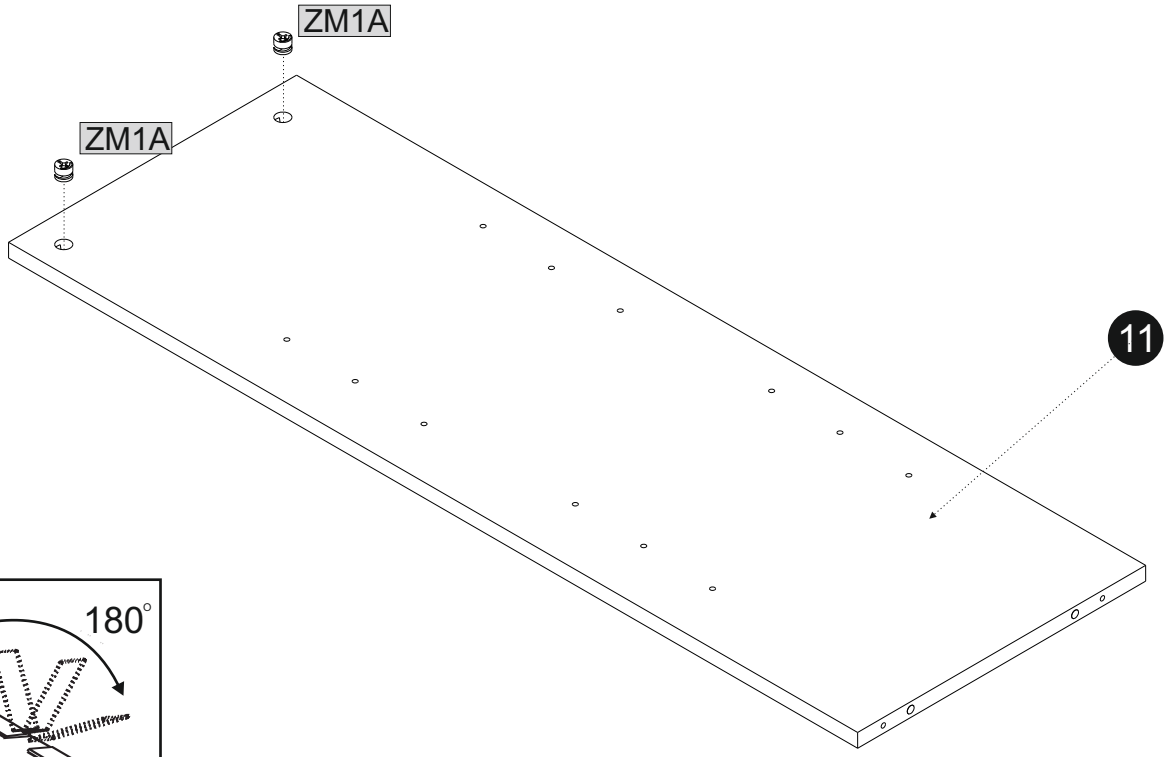

	15x15		8x35		
ZM1A	2	KD1	4	ZM1B	4

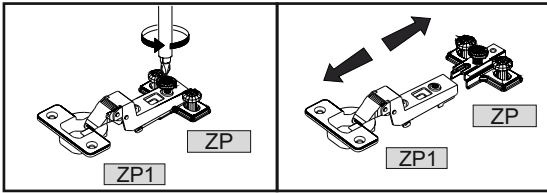





03

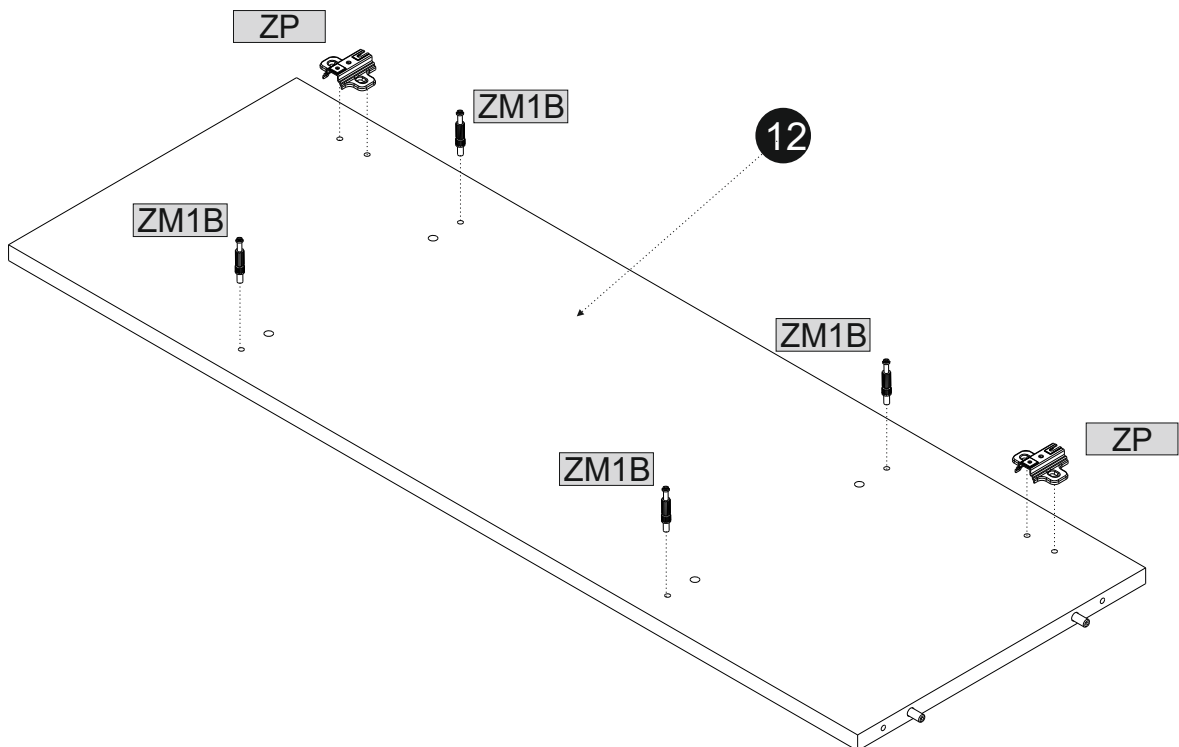
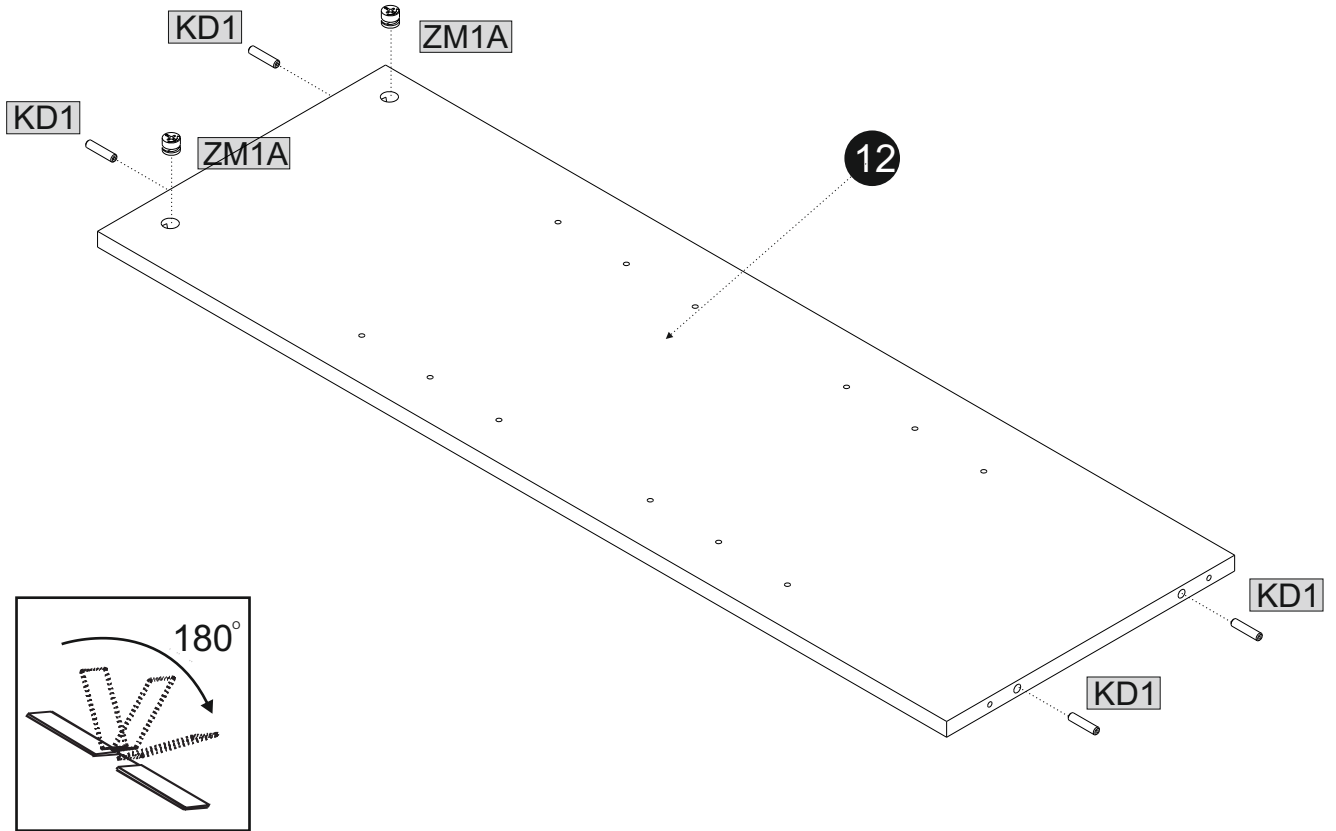



	15x15		8x35		
ZM1A	2	KD1	4	ZM1B	4
					
ZP					
2					

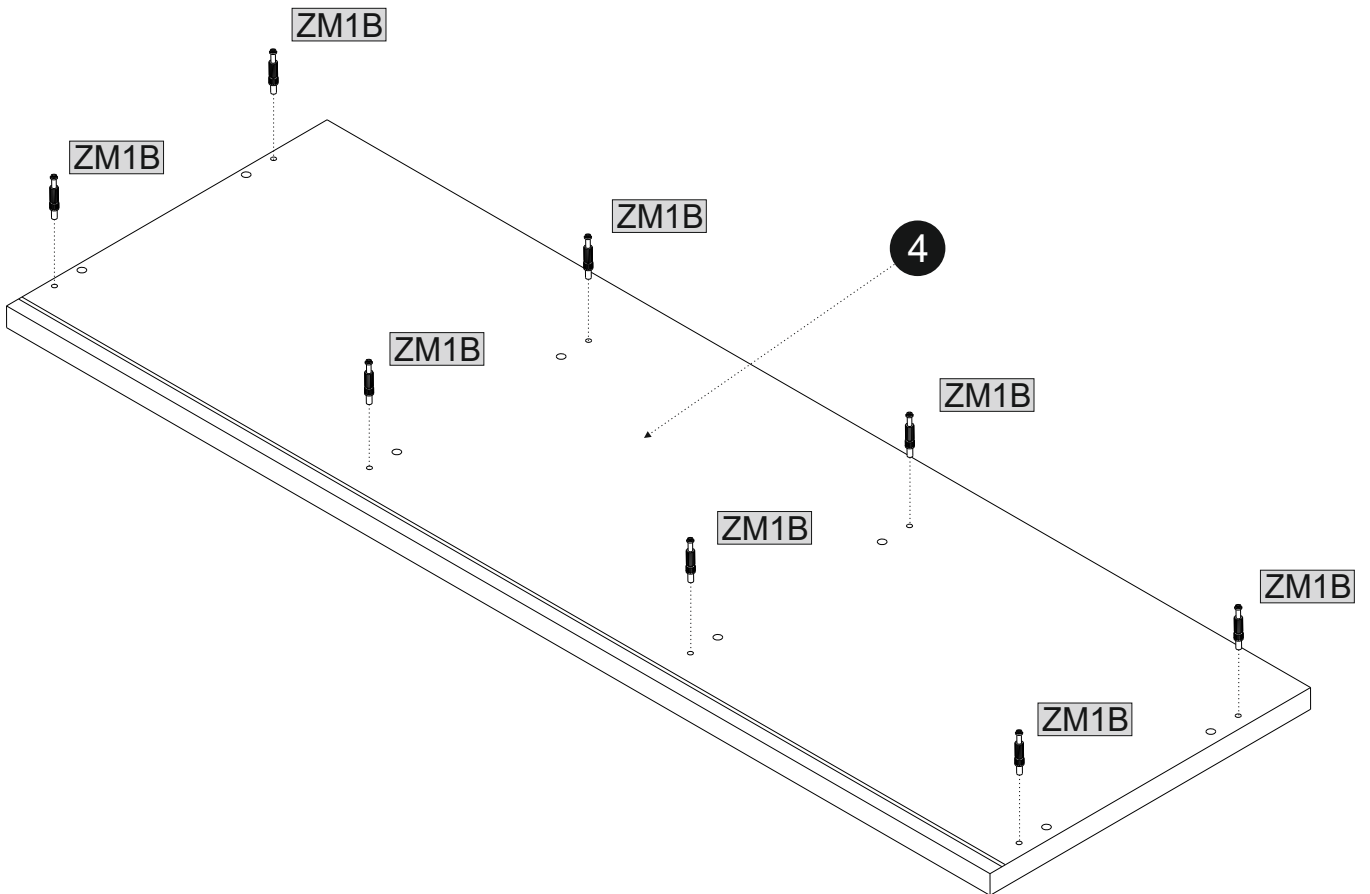
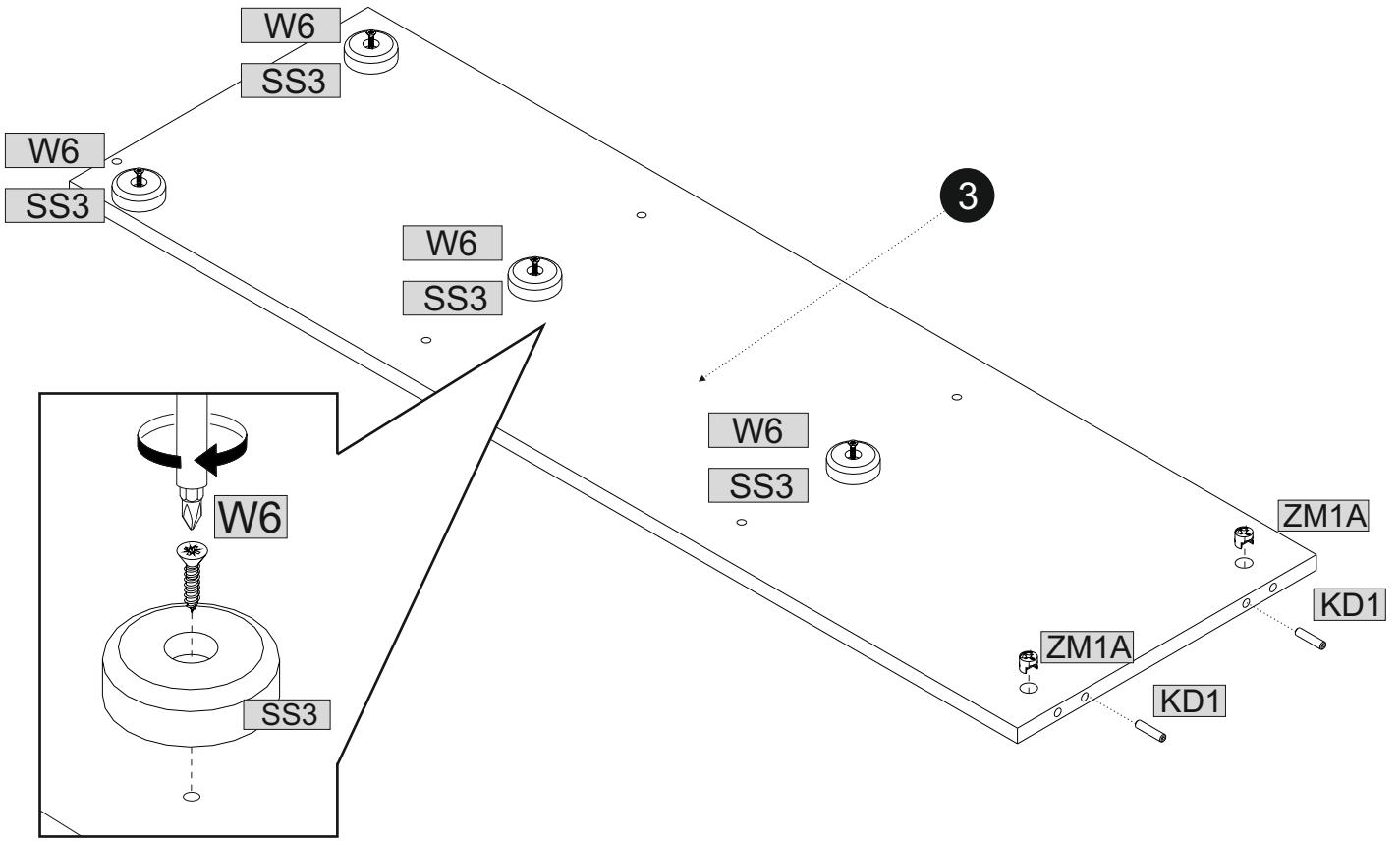

	8x35		4x20		15x15		
KD1	2	W6	4	ZM1A	2	ZM1B	8



05

	15x15		8x35
ZM1A	8	KD1	8

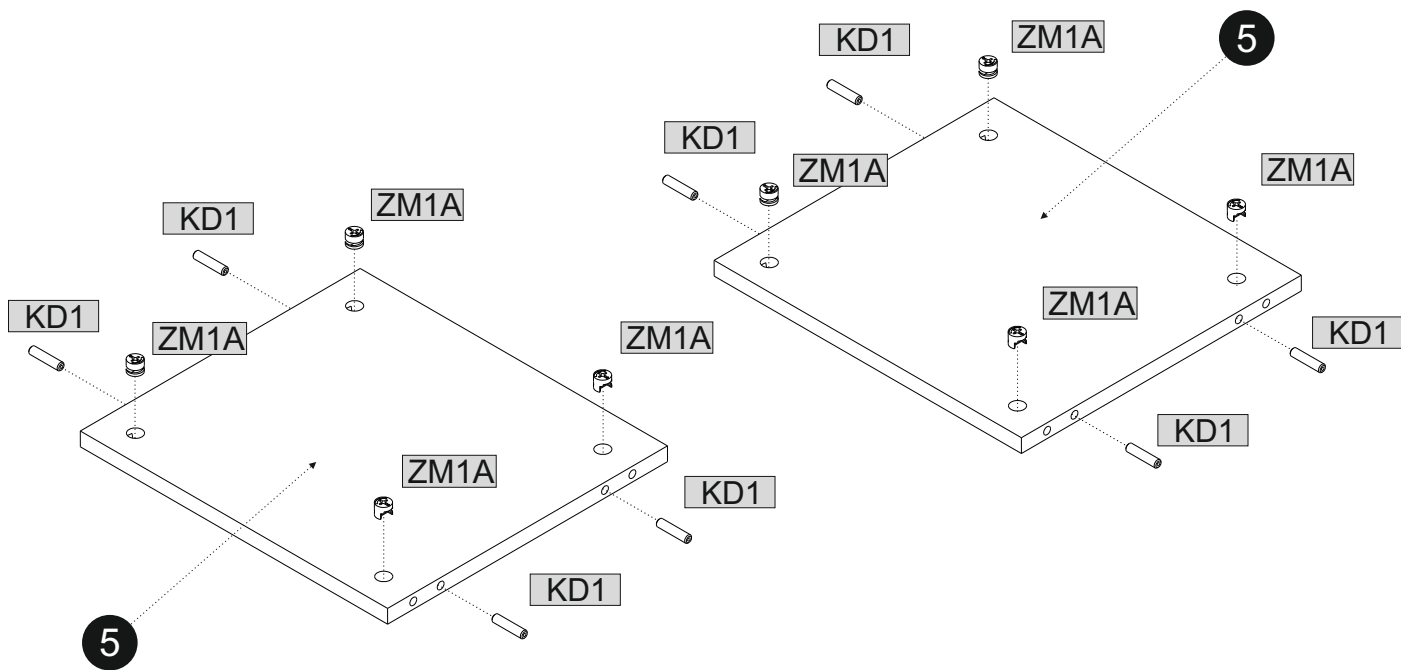

06

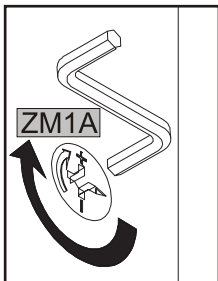

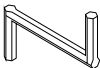
	
KK1	1

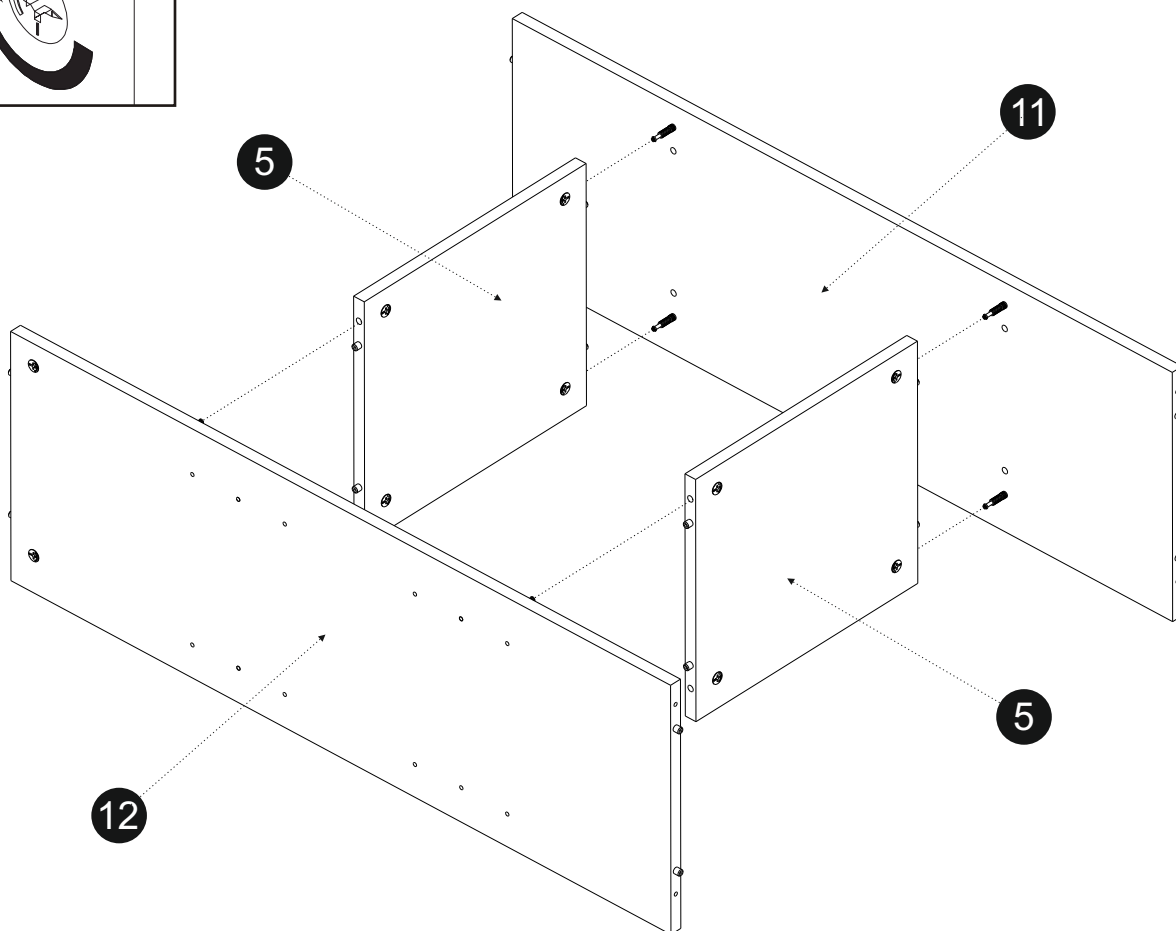

07

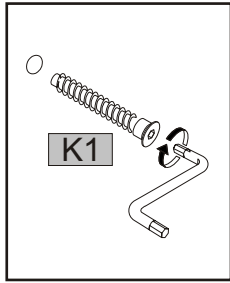
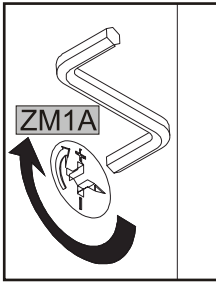

SG2	KK1	K1
2	1	6

7x50

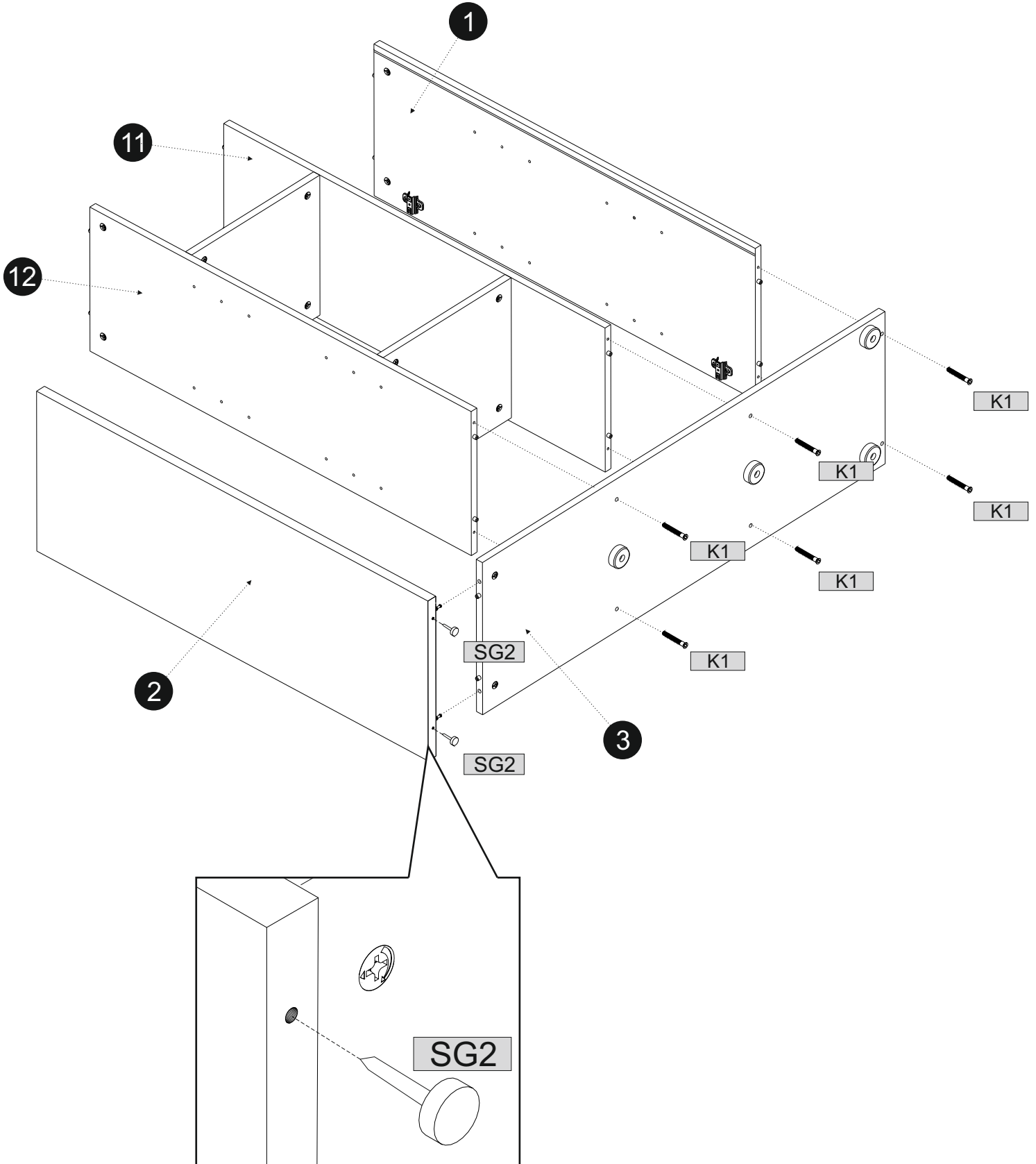

08

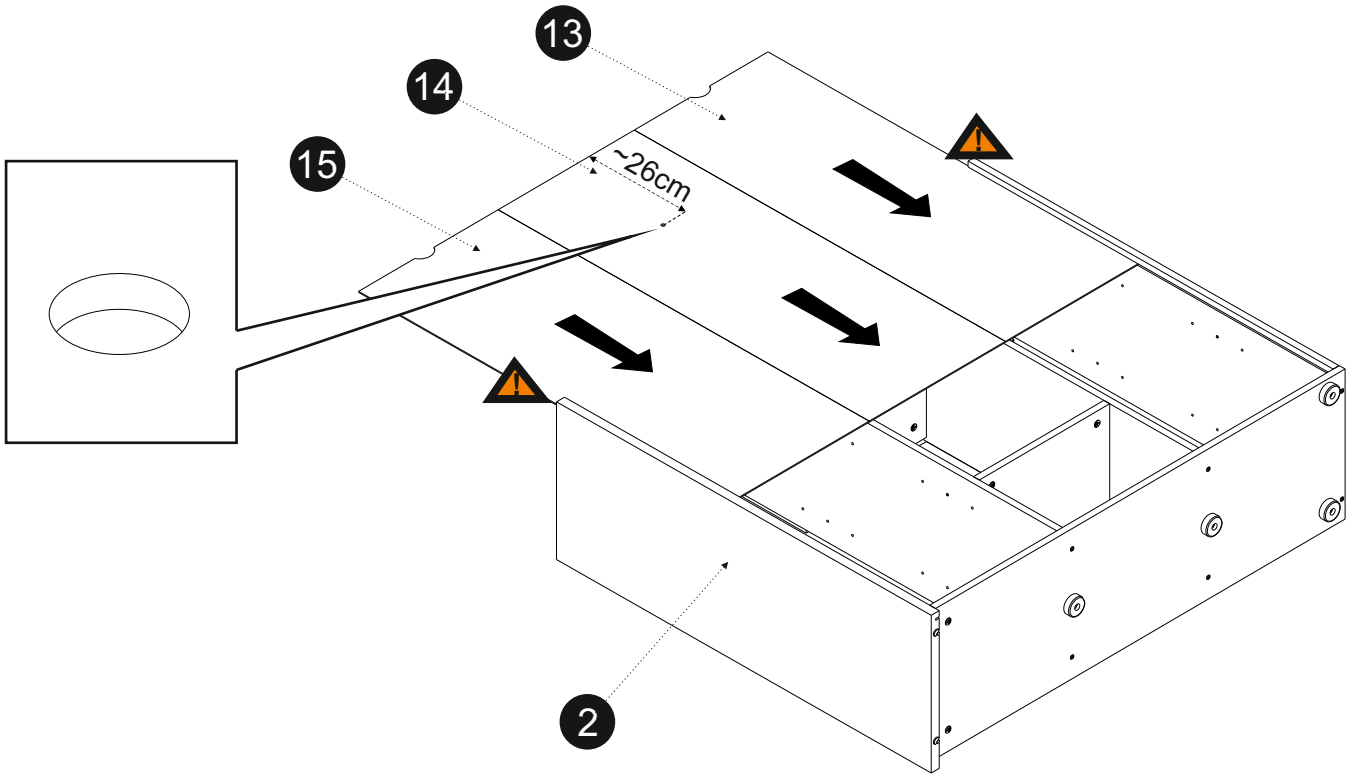
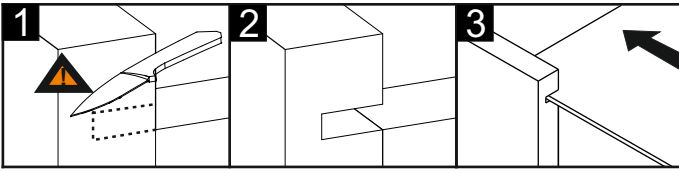

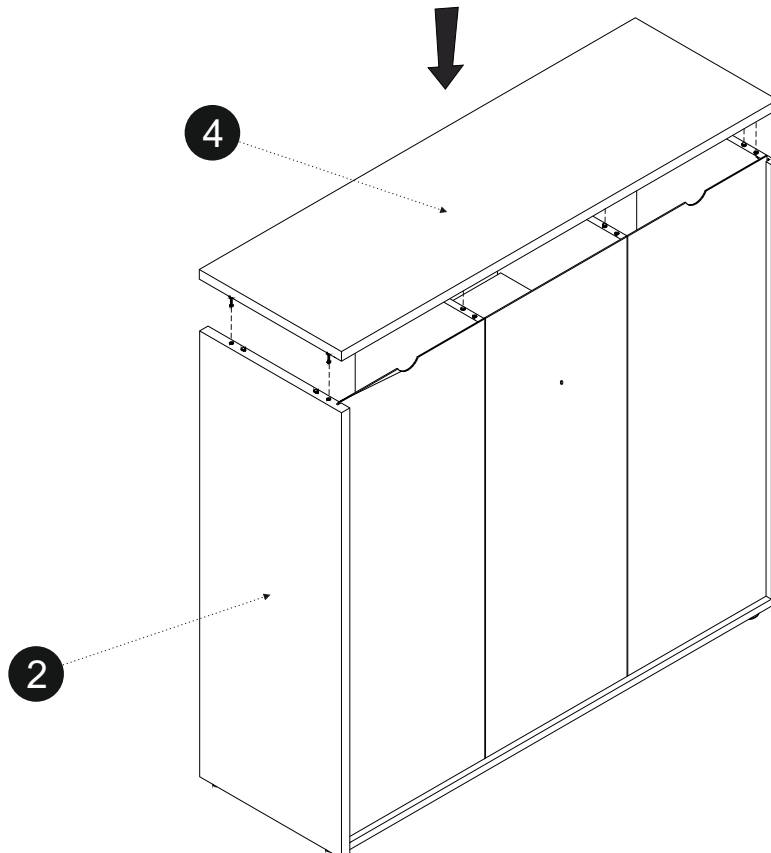
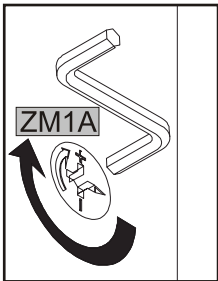

09

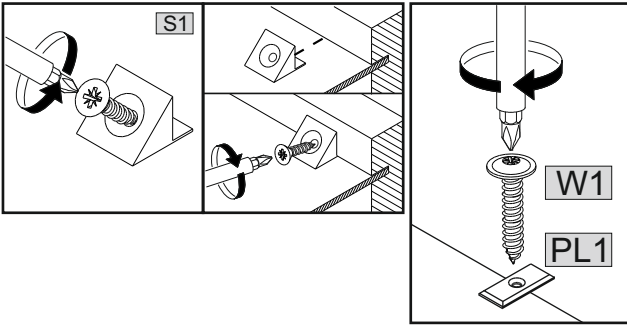

10

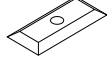

		
S1	PL1	W1
12	14	14

3x16

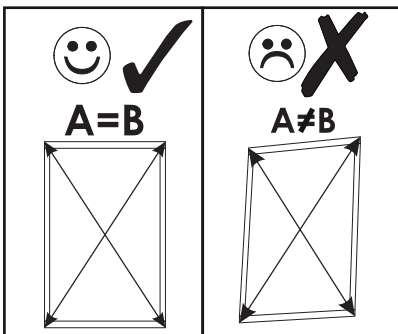
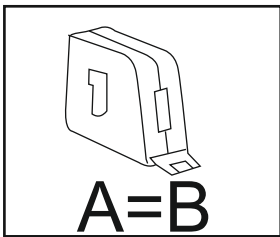
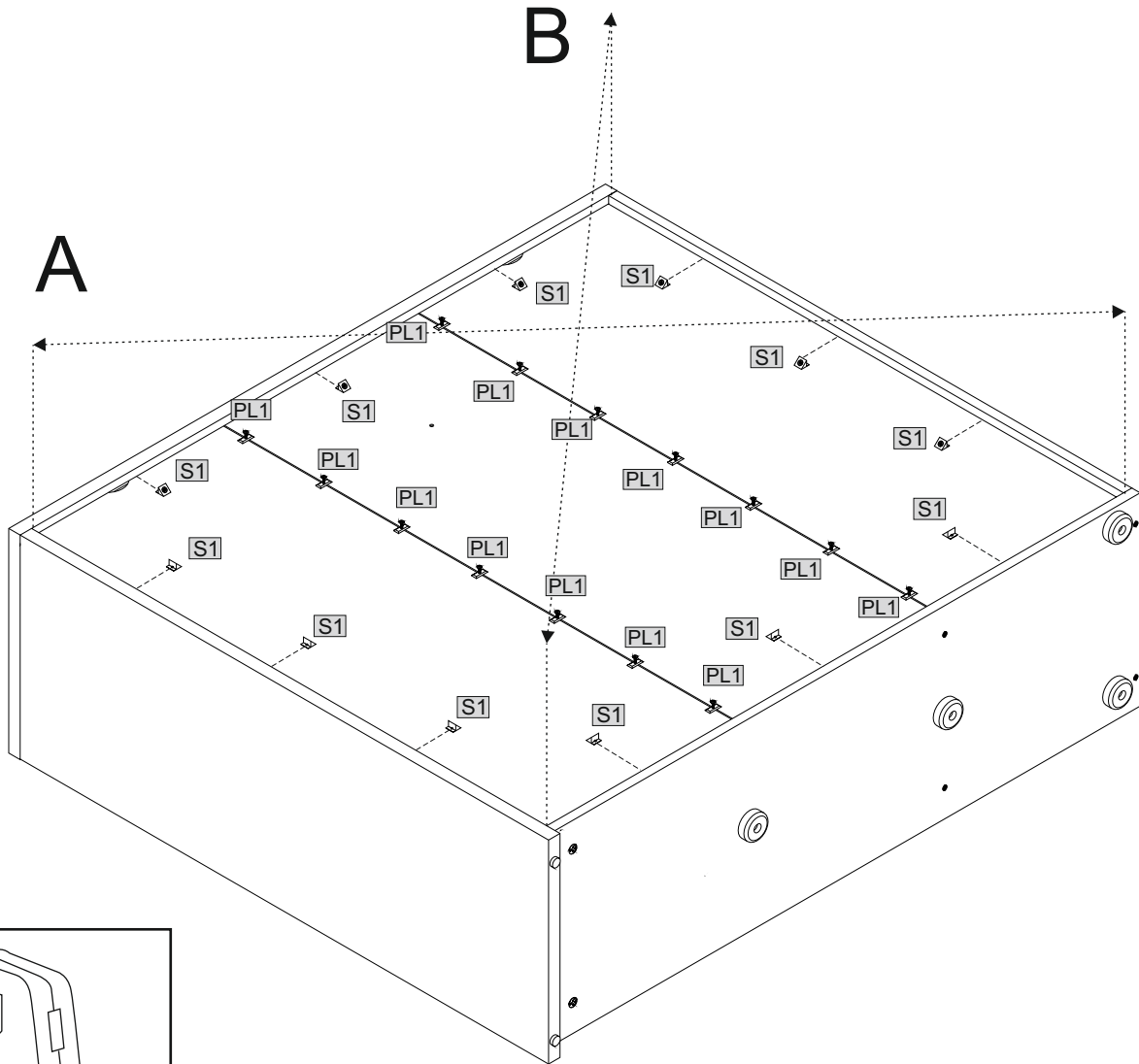

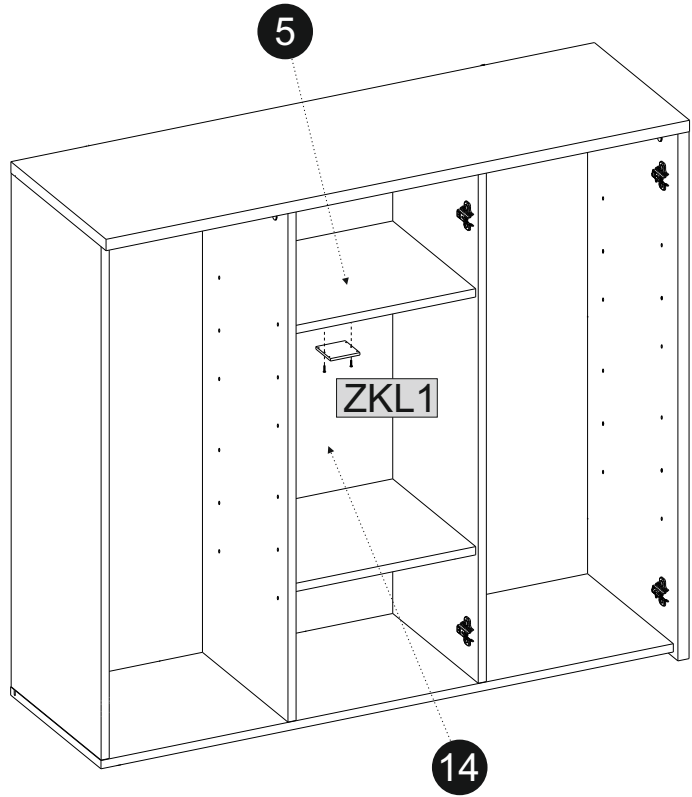
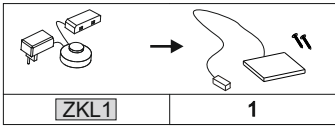
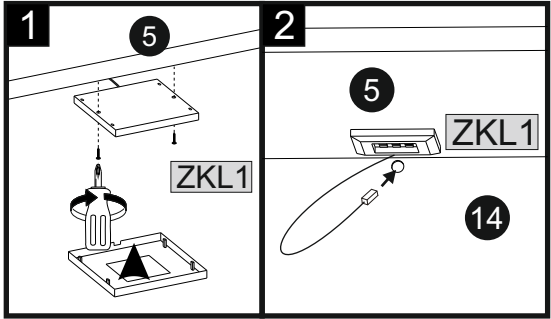

11



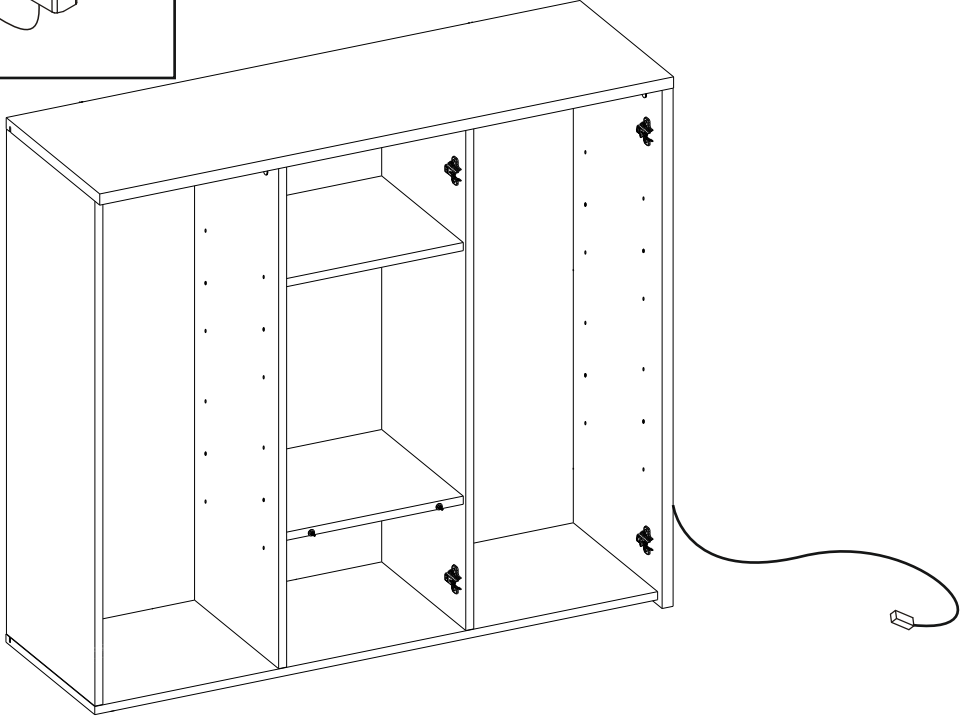
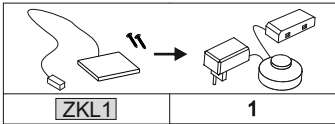
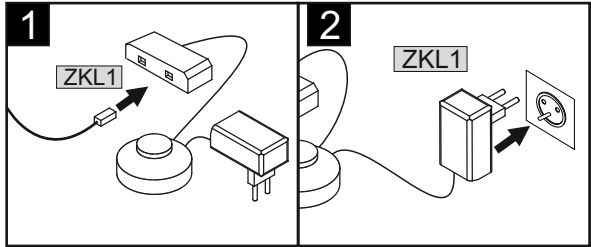

12

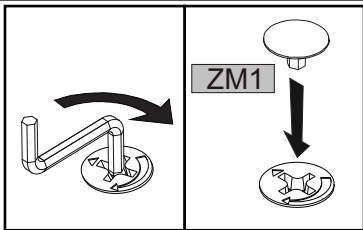
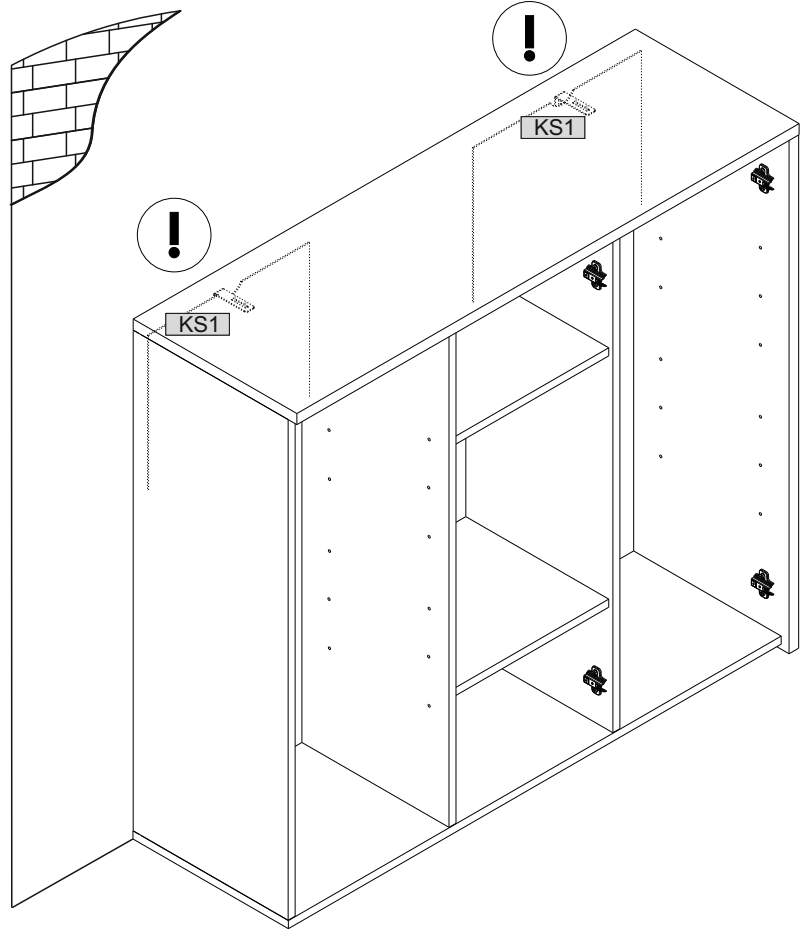
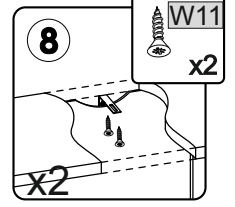
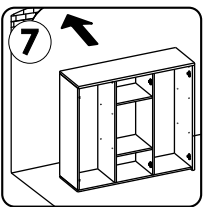
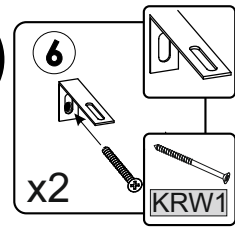
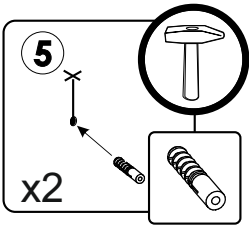
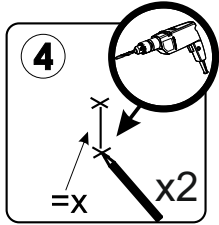
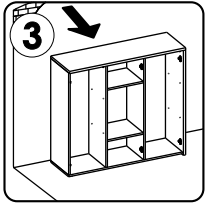
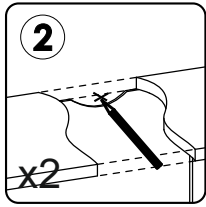
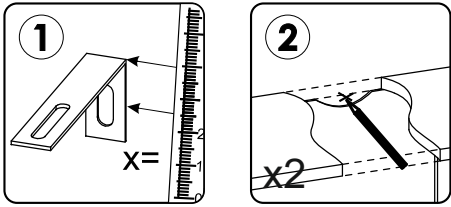

		
KS1	2	W11 3,5x16
		KRW1 08x40
		4
		2



	
ZM1	PP
16	16

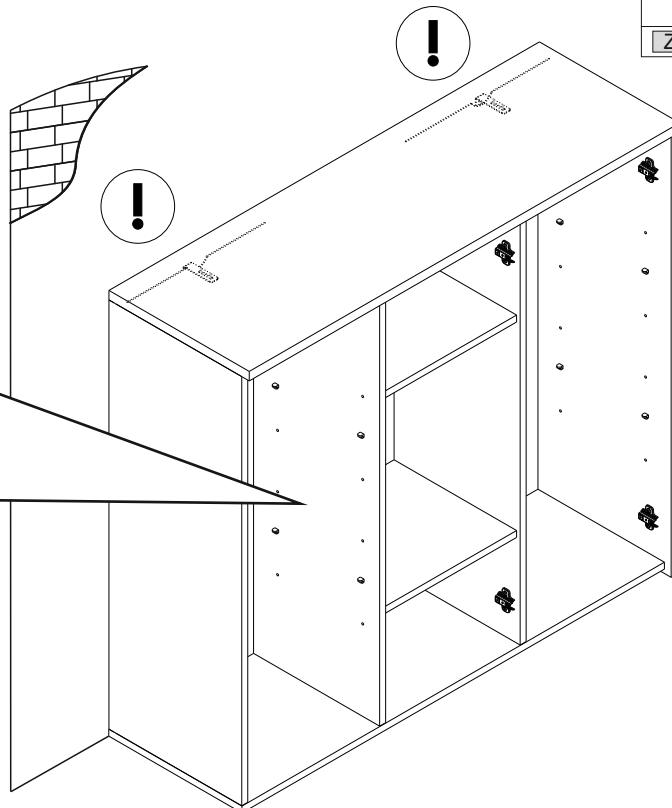
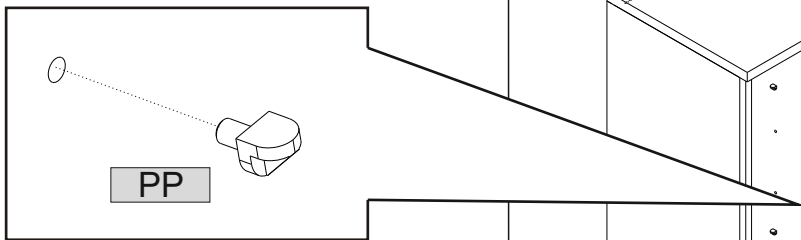

15

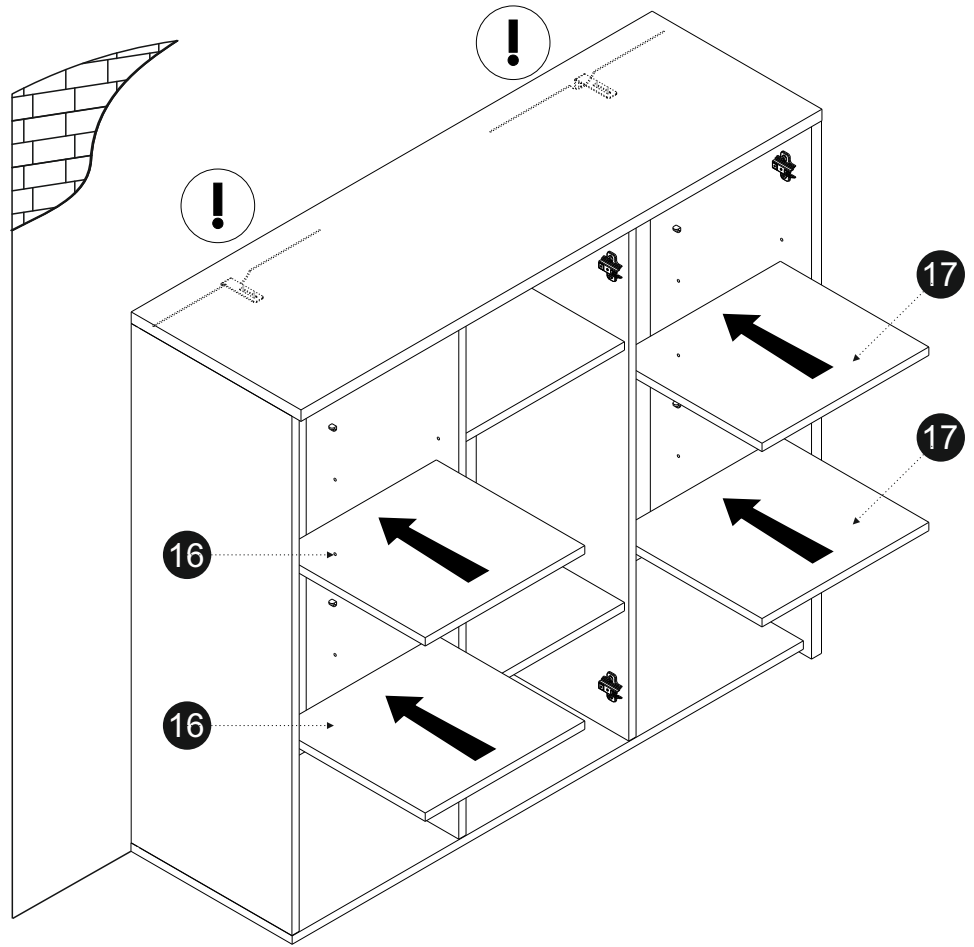
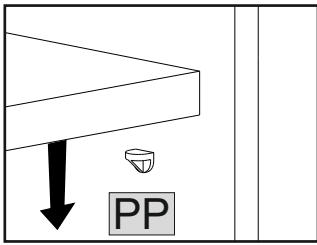

16

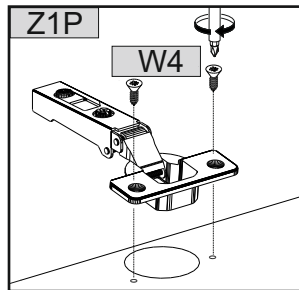
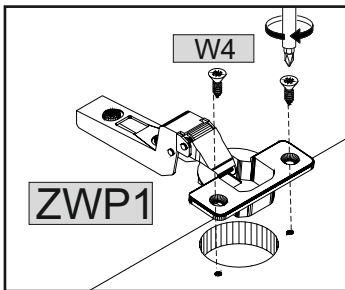

			4x13
Z1P	ZWP1	W4	8
2	2	8	

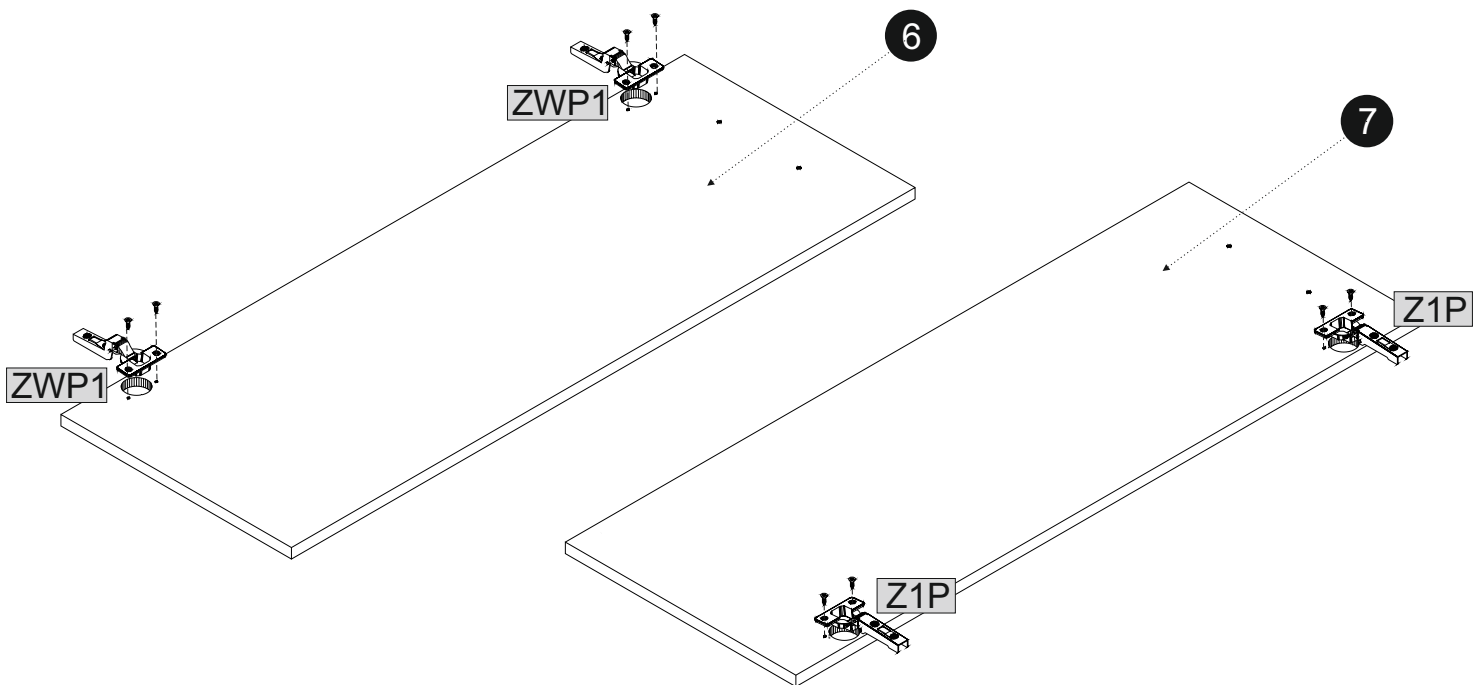

17

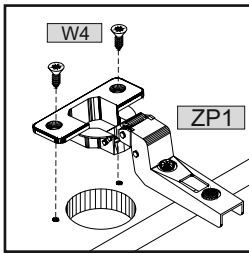

	4		4		2
					4

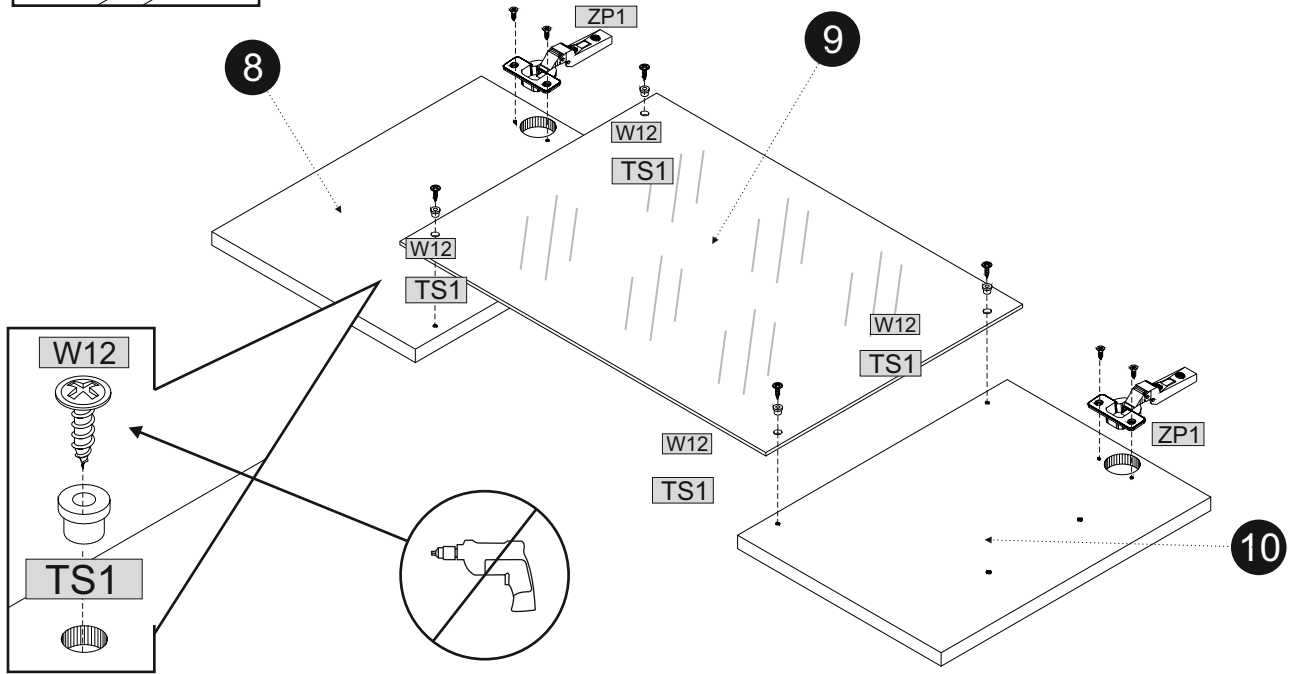

18

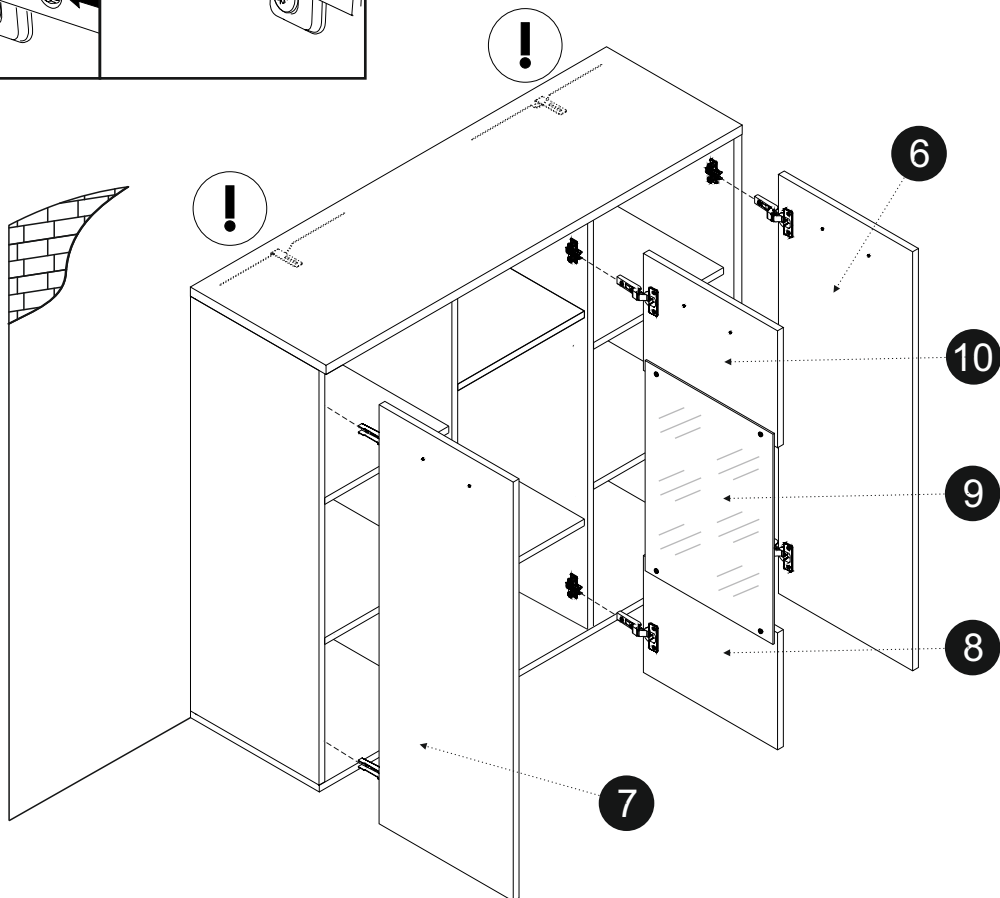
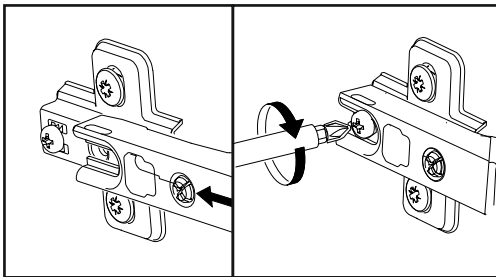

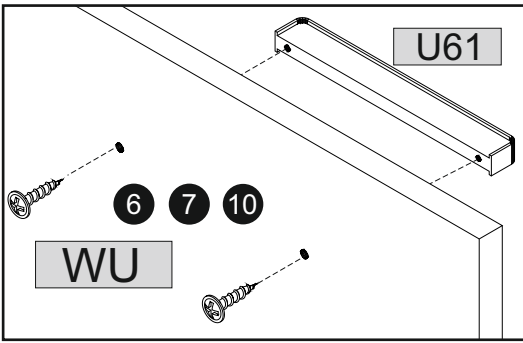

U61	3	WU	6

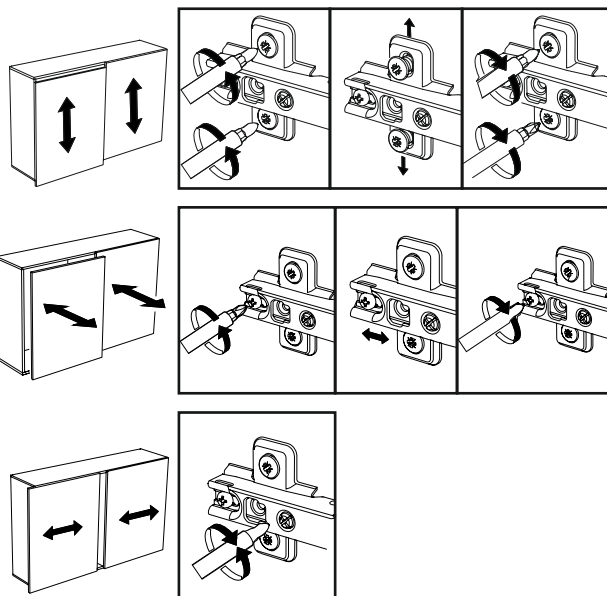
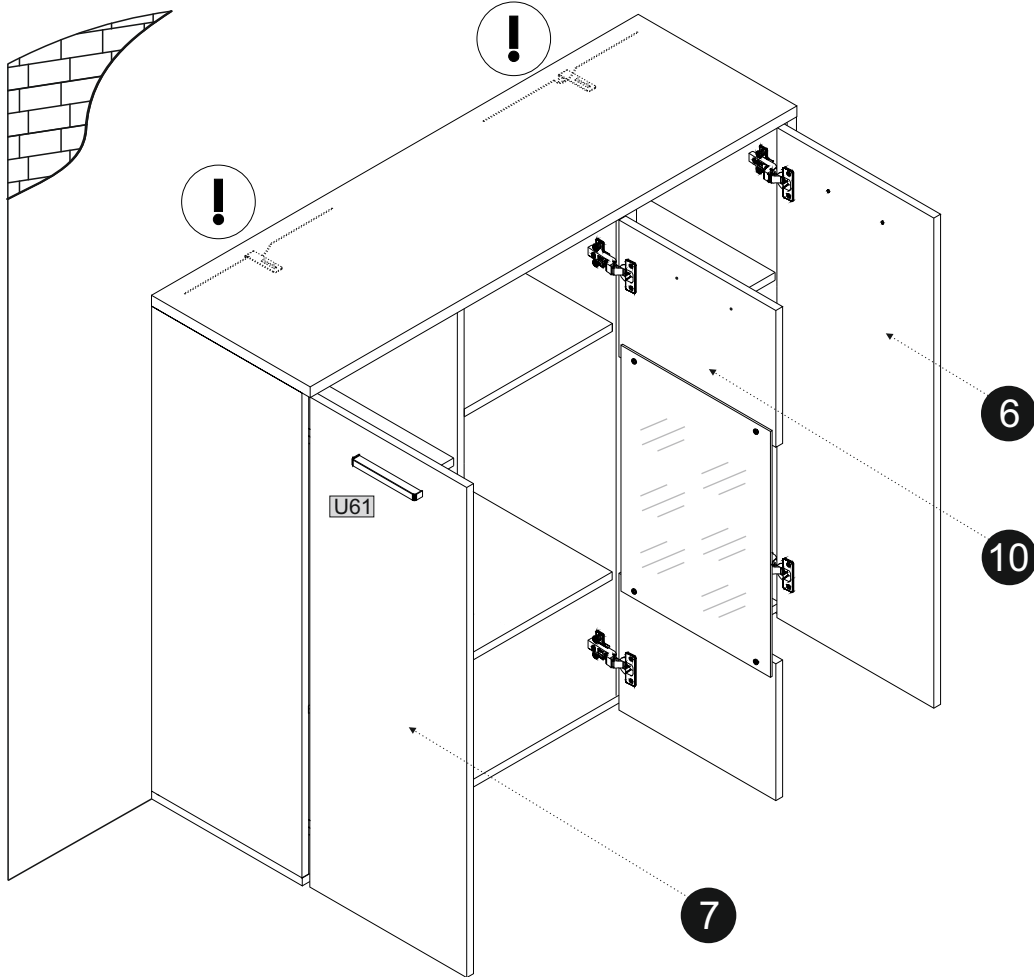

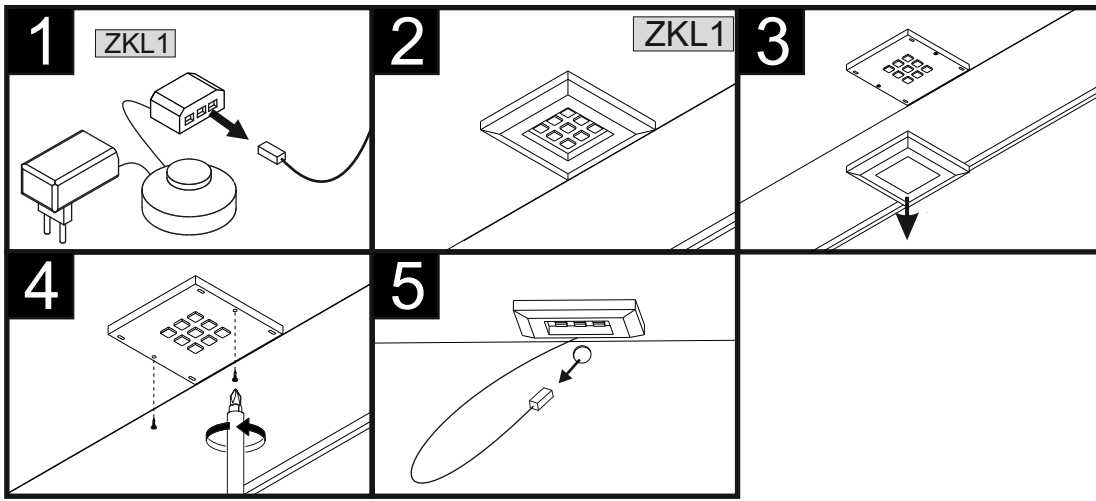

778282
SQUERE2S-PCB-CW

LED LED

230V

