

# NUBZ01

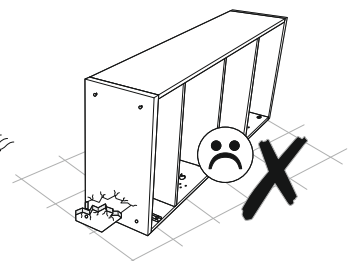

70 min

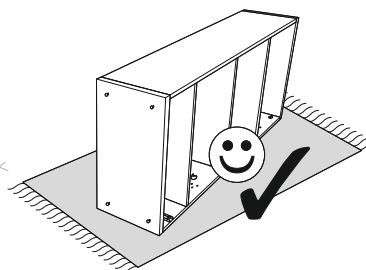

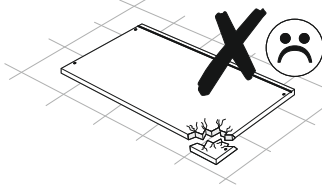
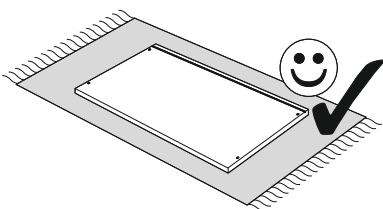
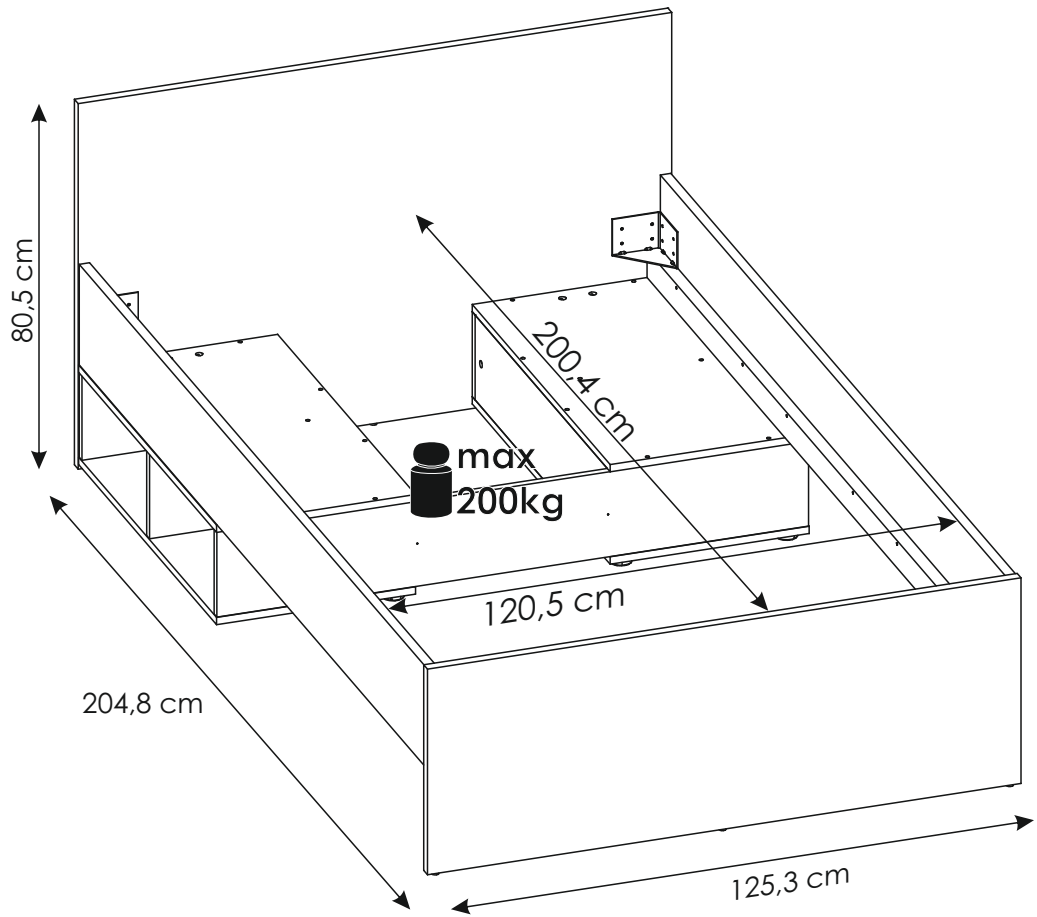
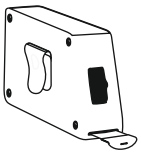
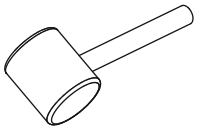
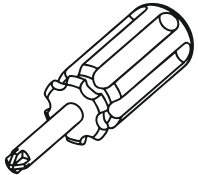
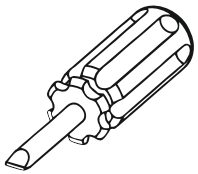
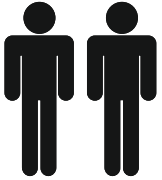
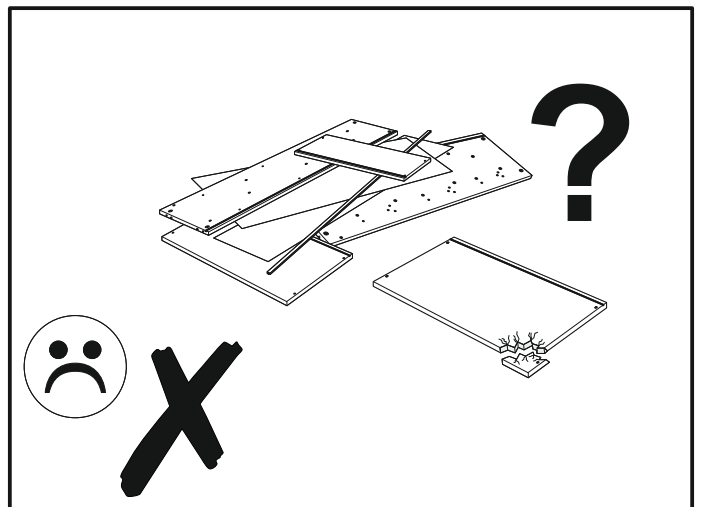
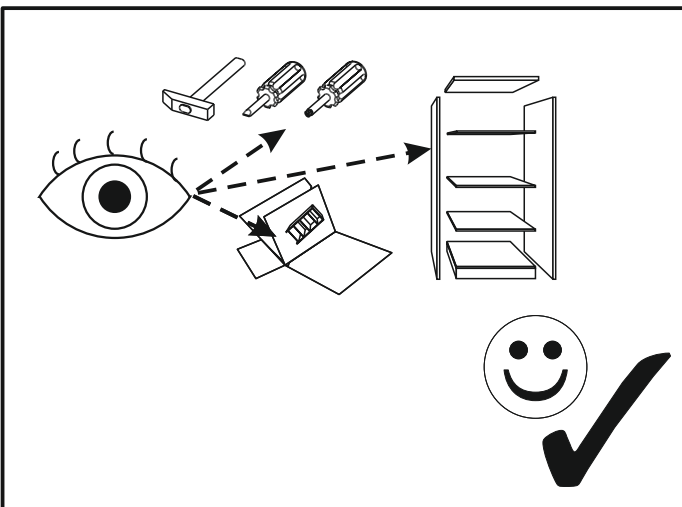
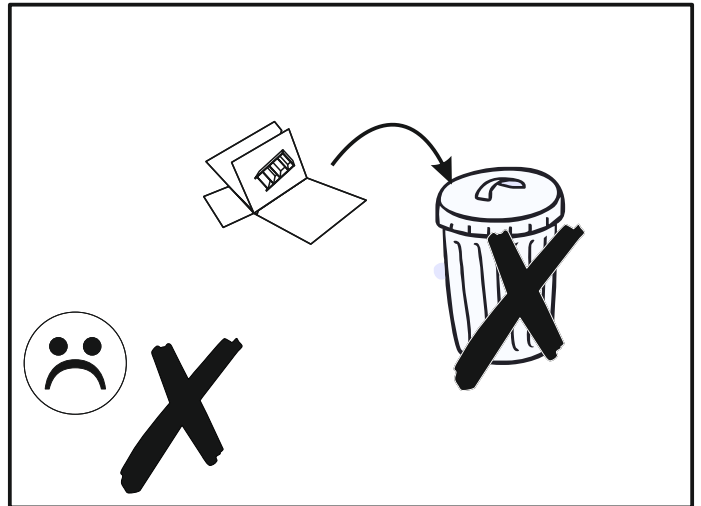
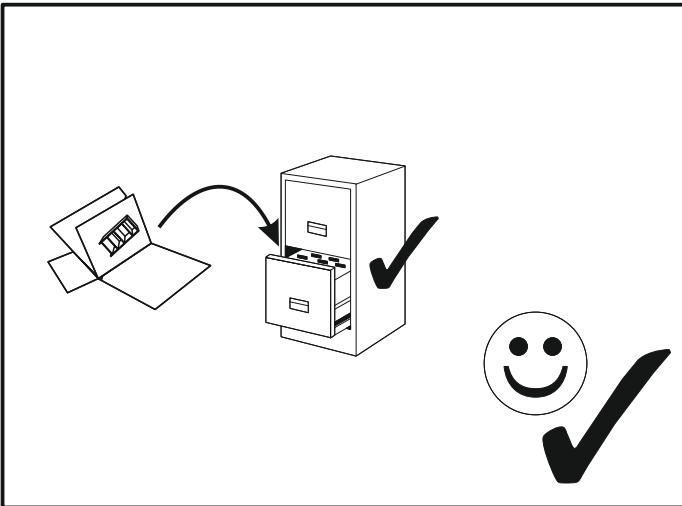
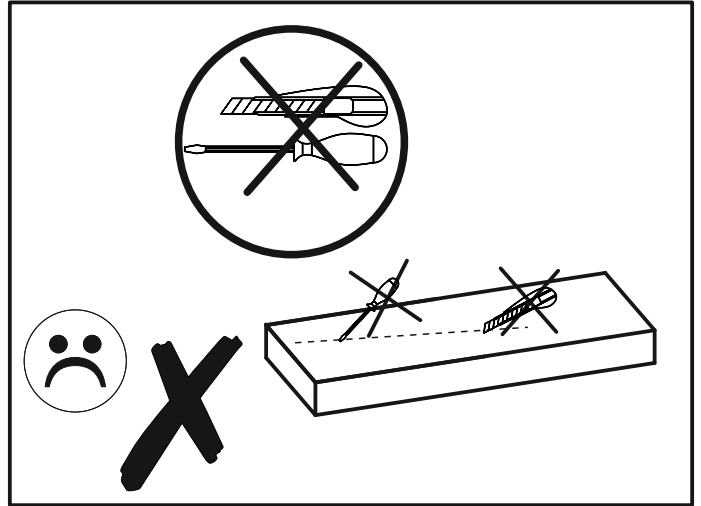
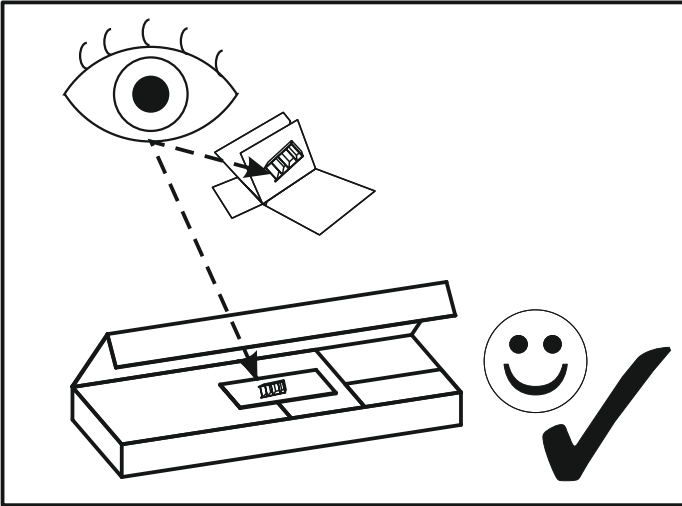

# NUBZ01

<b>A1</b>	8 x 35 mm	x66	<b>C2</b>	5 x 13 mm	x32	<b>E1</b>	15 x 12 mm	x20
<b>F1</b>	6 x 34 mm	x20	<b>G1</b>	7 x 50 mm	x36	<b>I10</b>	3,5 x 22 mm	x6
<b>J11</b>	4 x 45mm	x12	<b>M</b>		x1	<b>O2</b>		x6
<b>O3</b>	Ø45	x6	<b>X5</b>		x4			

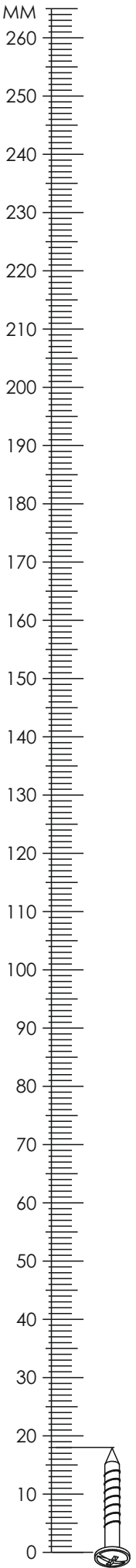

# NUBZ01

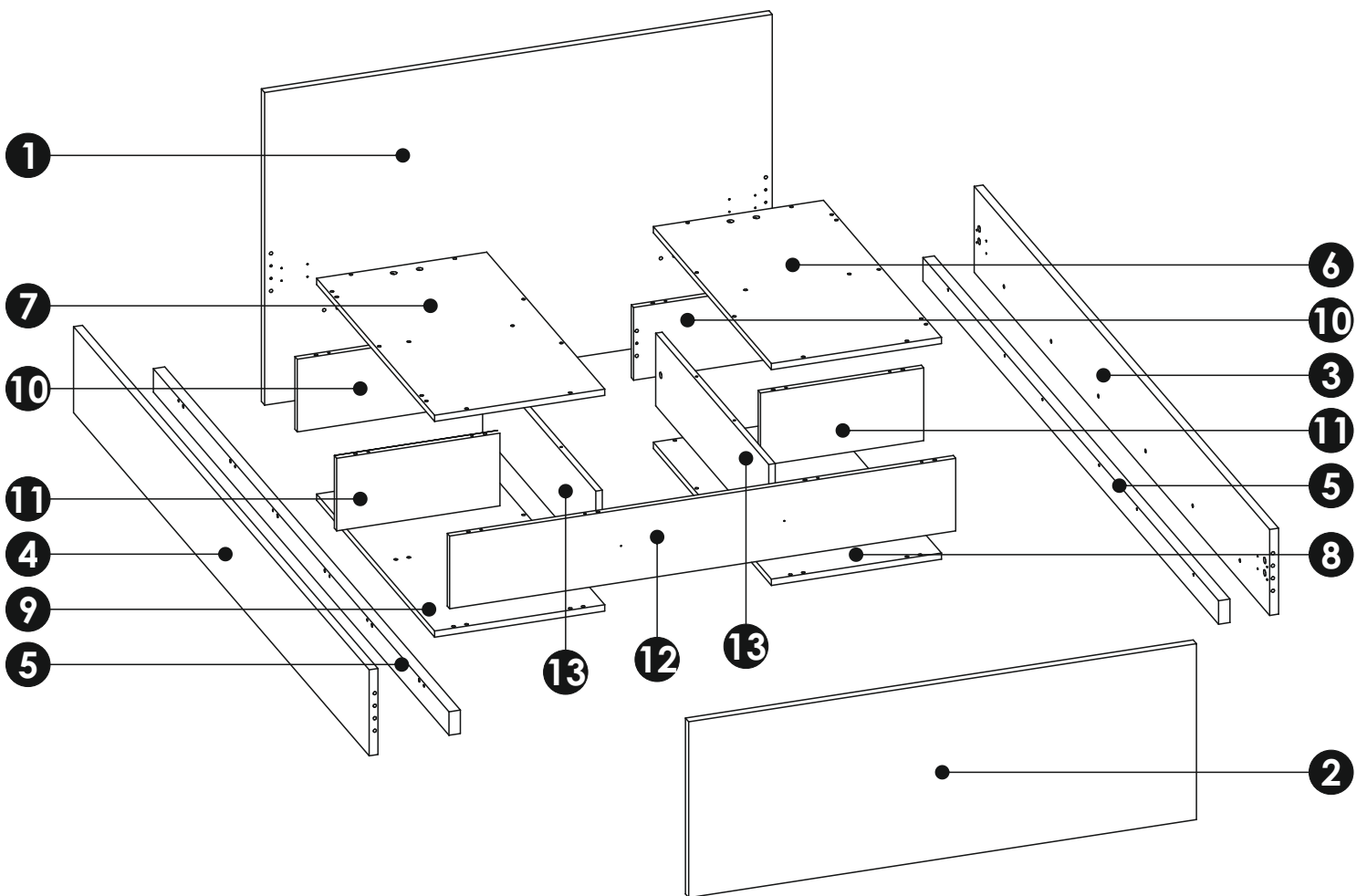
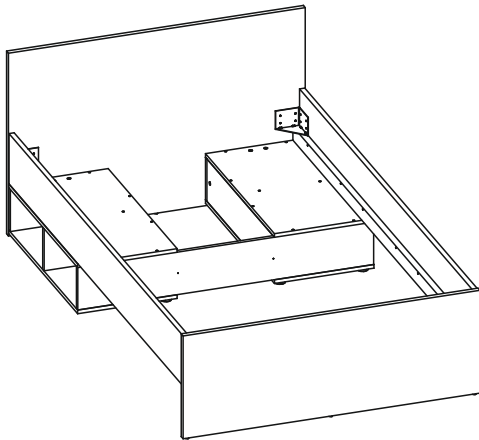

<b>1</b>	1253	800	22	x1	3/3
<b>2</b>	1253	450	22	x1	3/3
<b>3</b>	2004	220	22	x1	2/3
<b>4</b>	2004	220	22	x1	2/3
<b>5</b>	2004	60	28	x2	2/3

<b>6</b>	800	420	16	x1	1/3
<b>7</b>	800	420	16	x1	1/3
<b>8</b>	800	420	16	x1	1/3
<b>9</b>	800	420	16	x1	1/3
<b>10</b>	419	186	16	x2	1/3

<b>11</b>	403	186	16	x2	1/3
<b>12</b>	1249	186	16	x1	3/3
<b>13</b>	767	186	16	x2	1/3

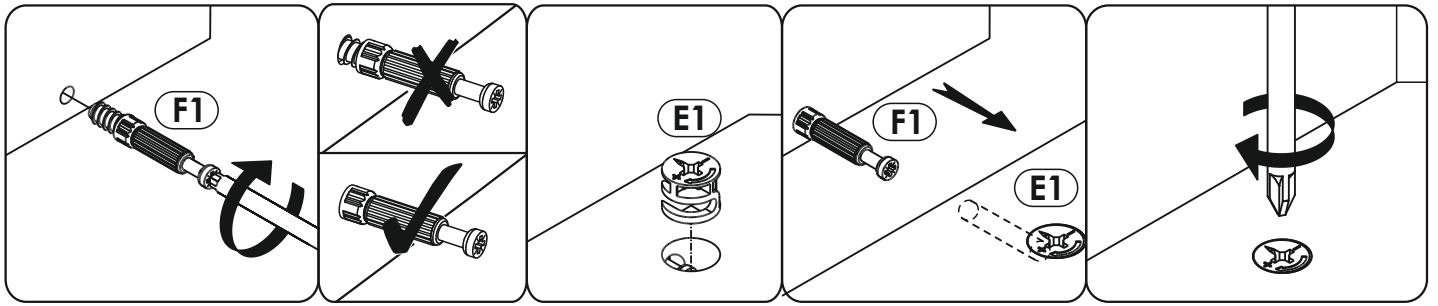

1 ▶

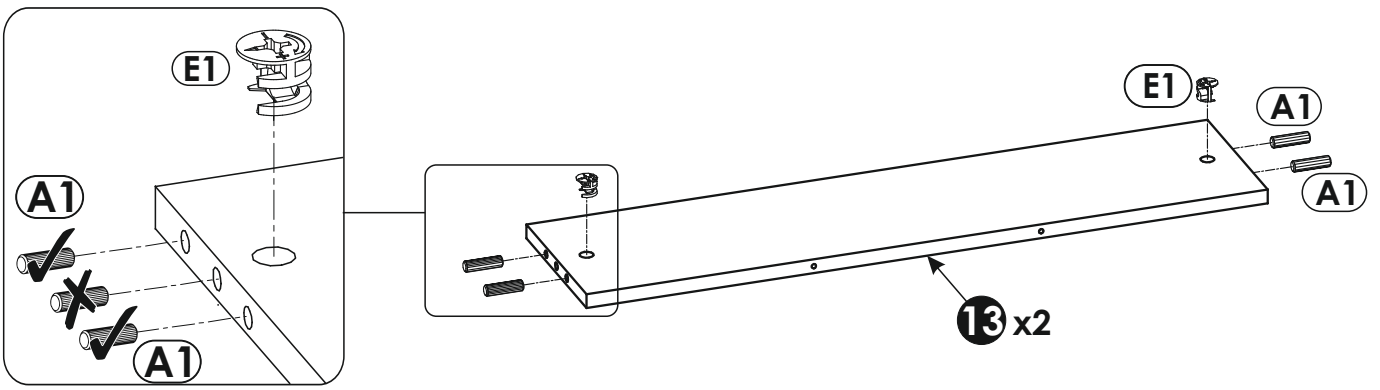
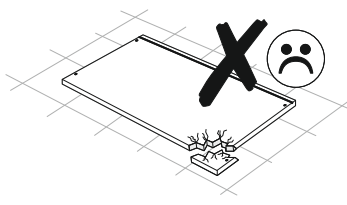
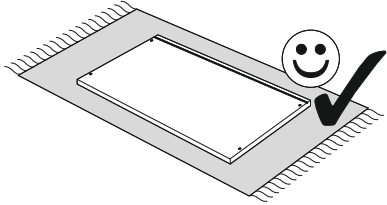

2 ▶

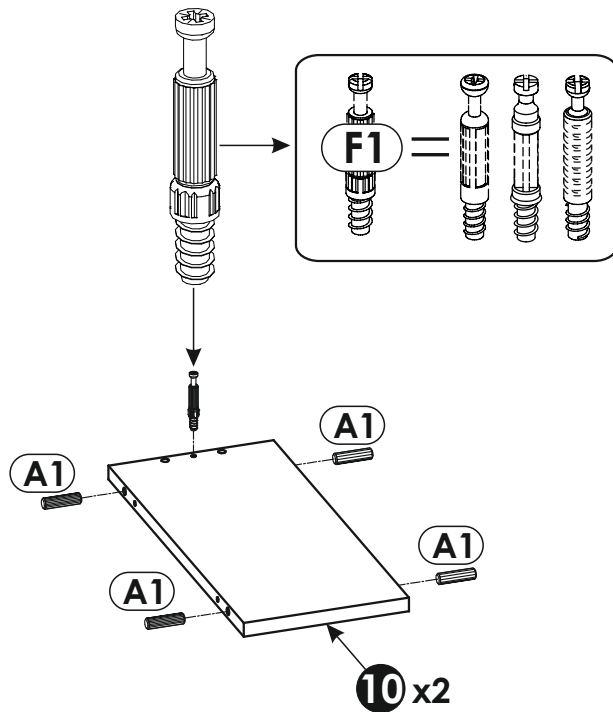
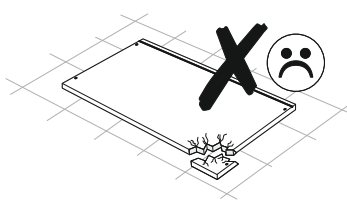
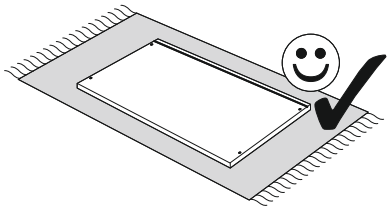

3 ▶

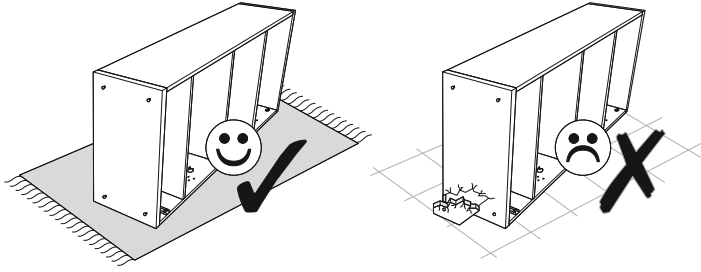

x2

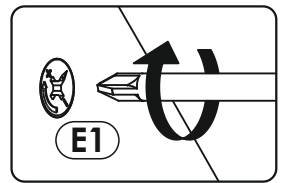
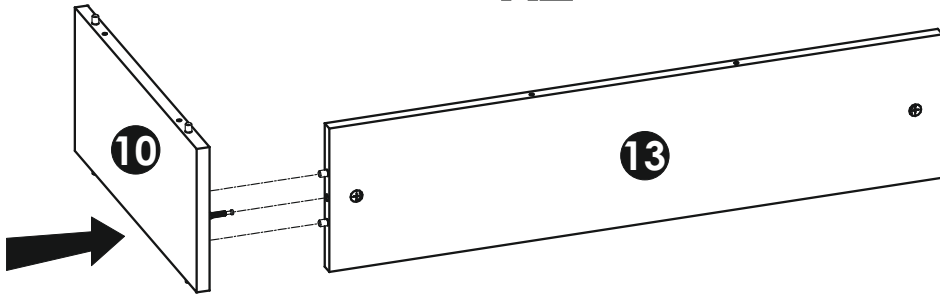

4 ▶

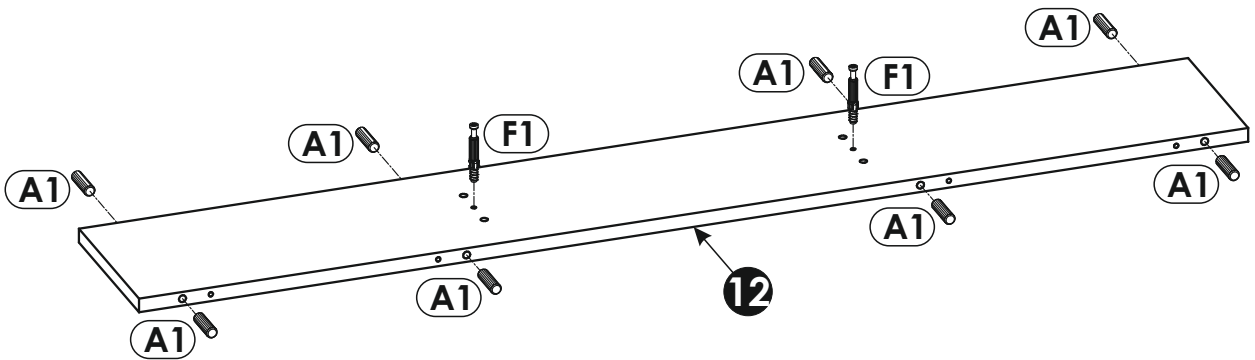
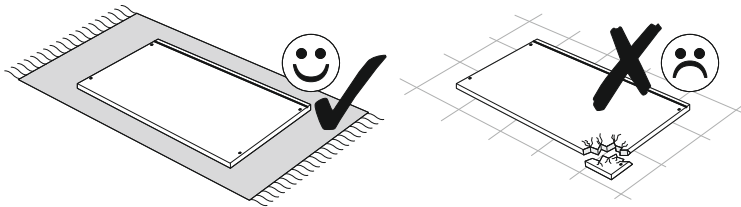

5 ▶

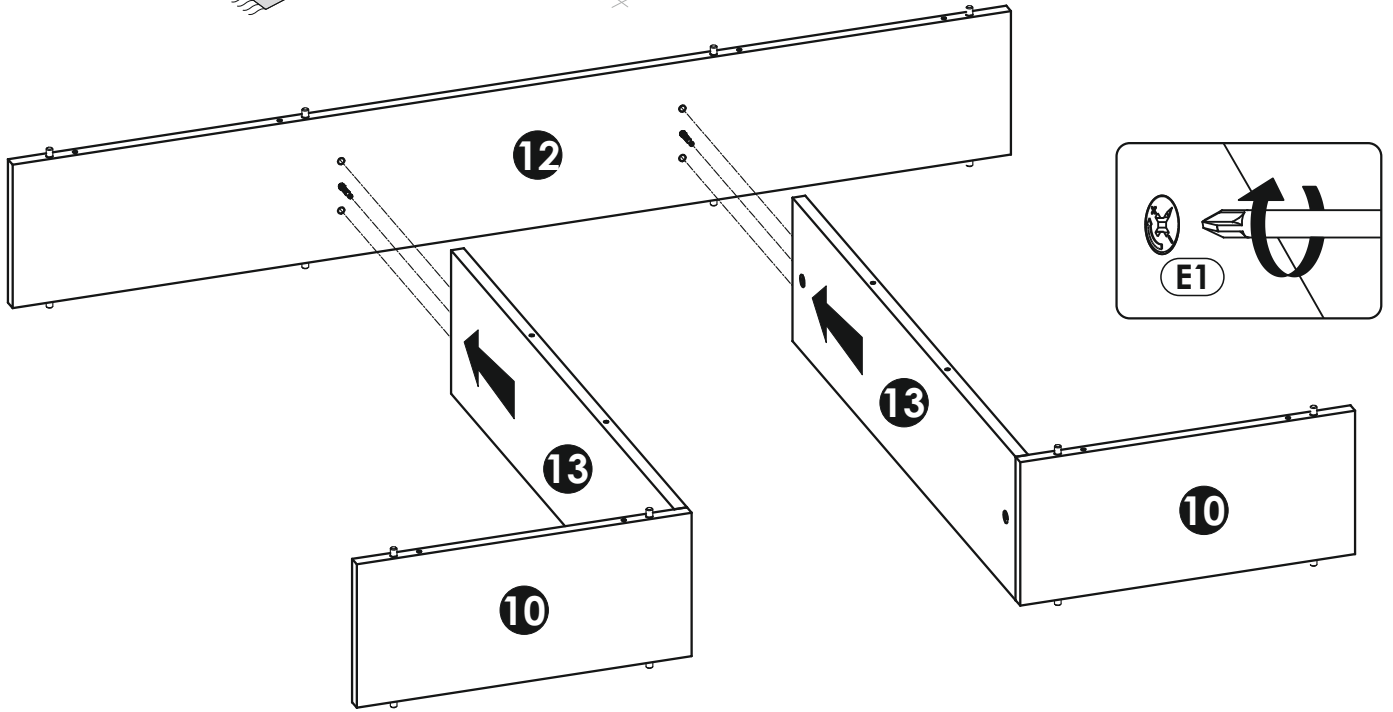
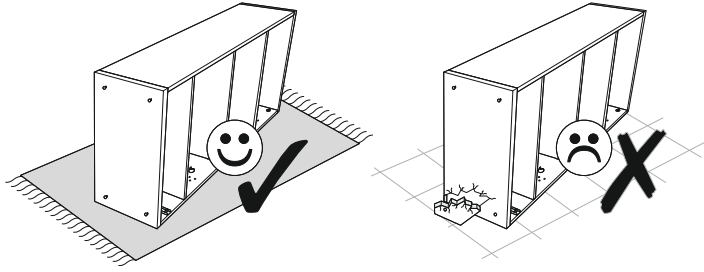

6 ▶

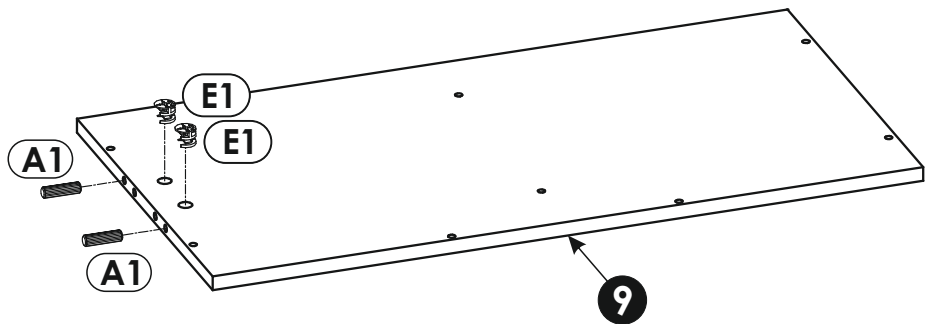
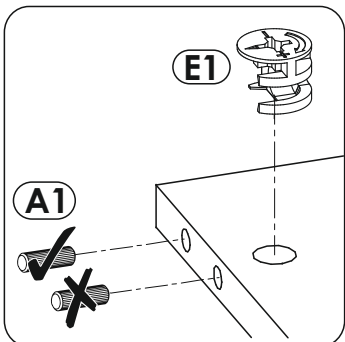
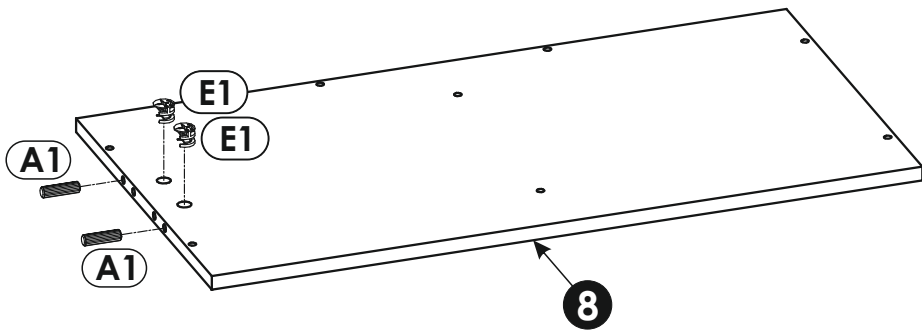
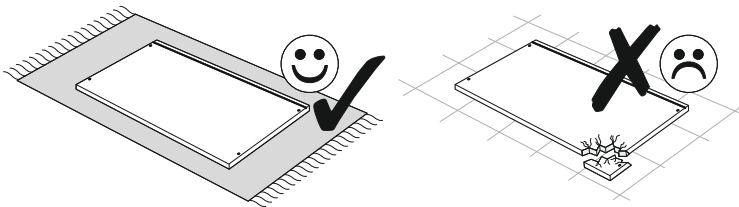

7 ▶

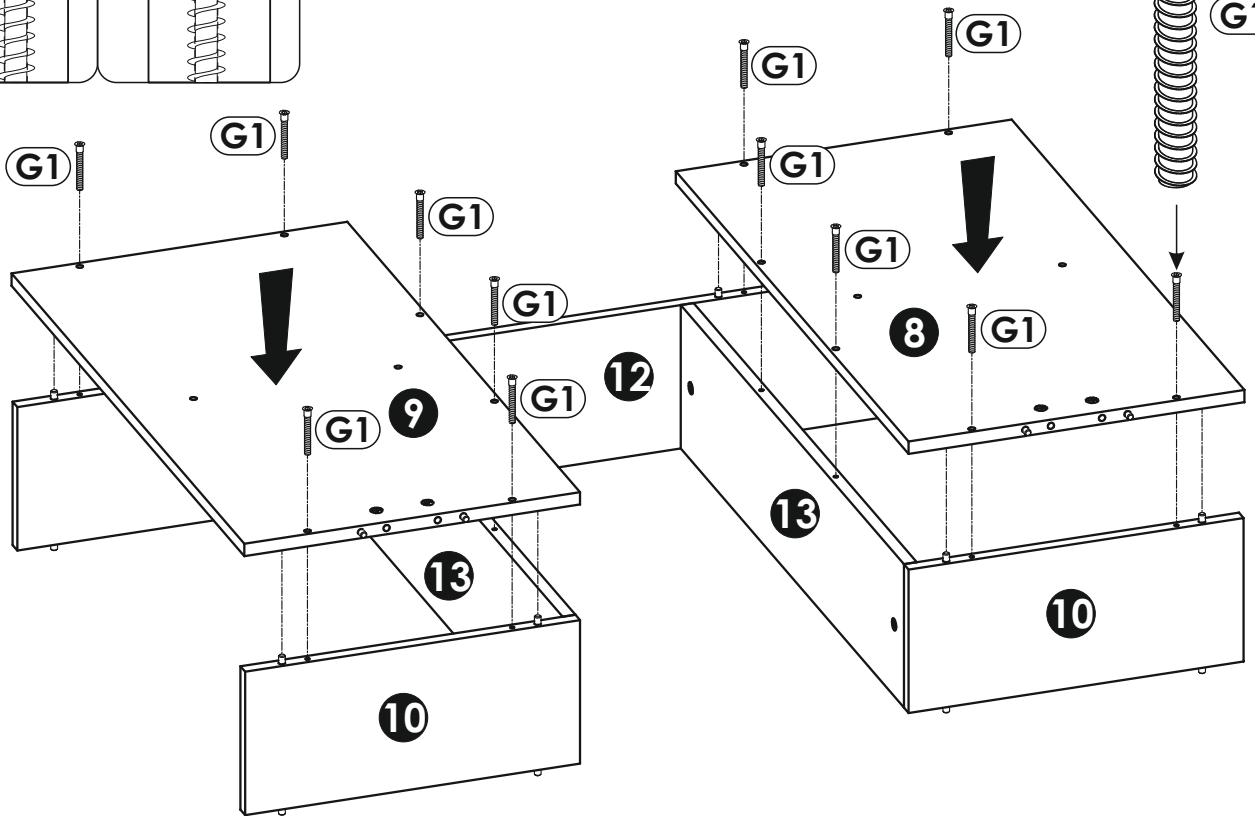
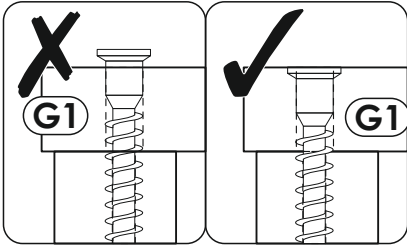
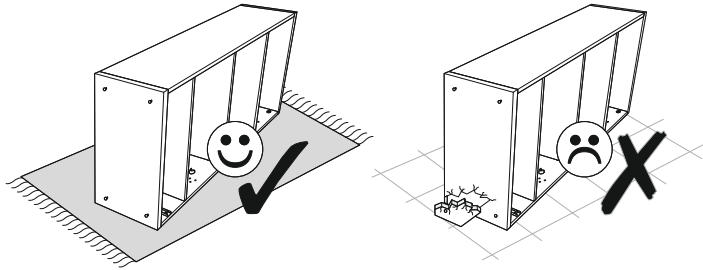

8 ▶

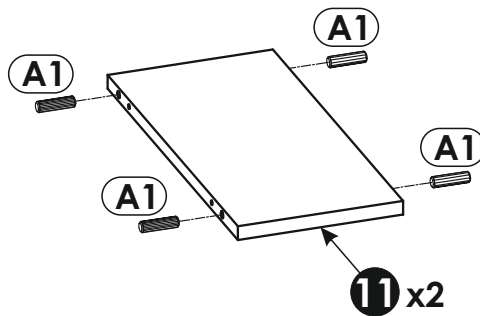
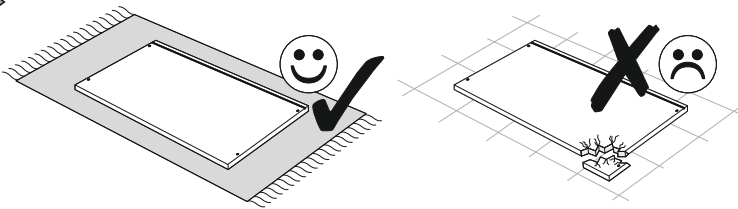



9 ▶

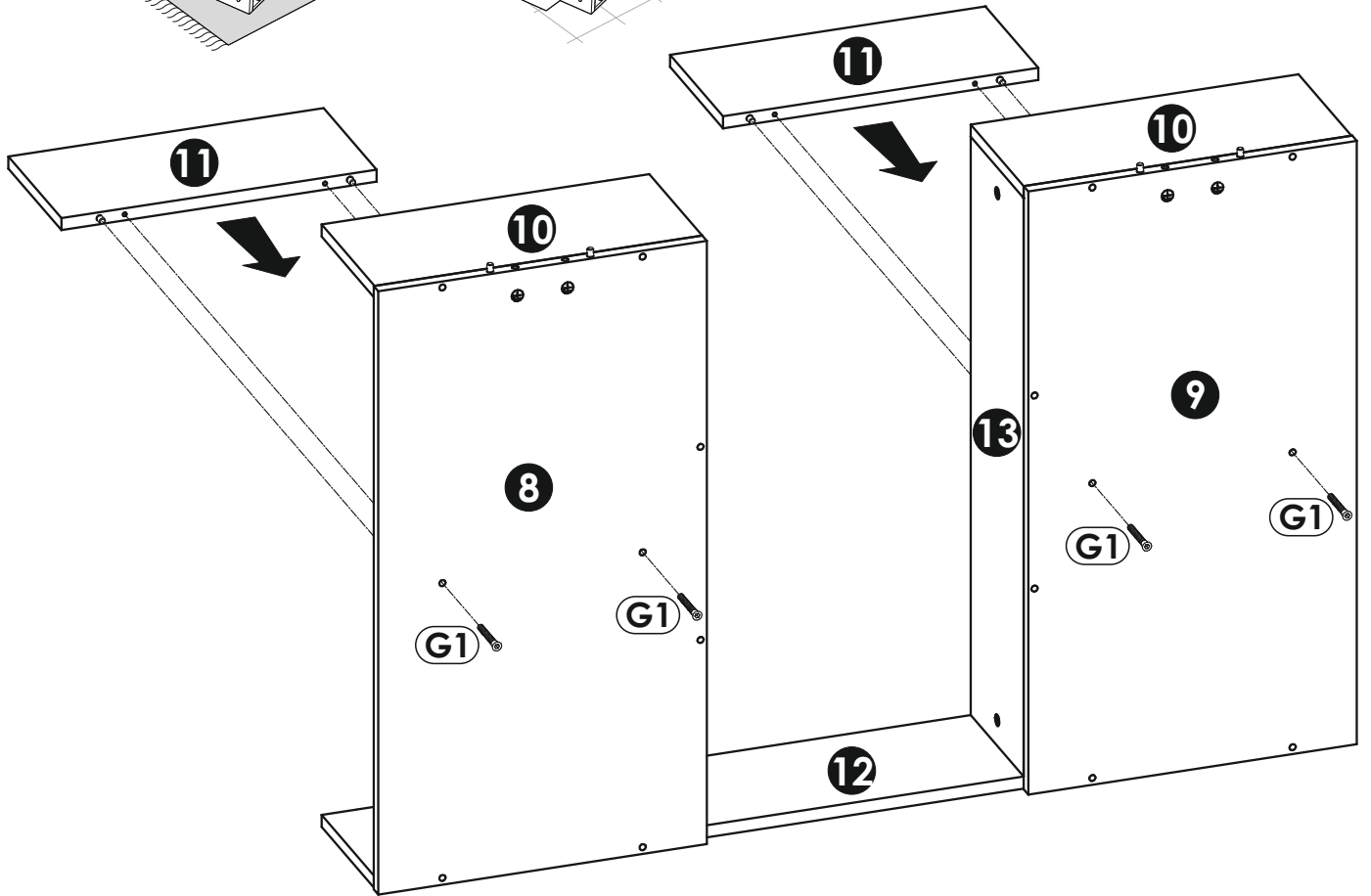
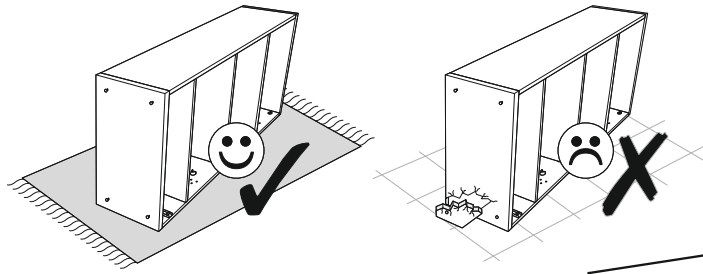

10 ▶

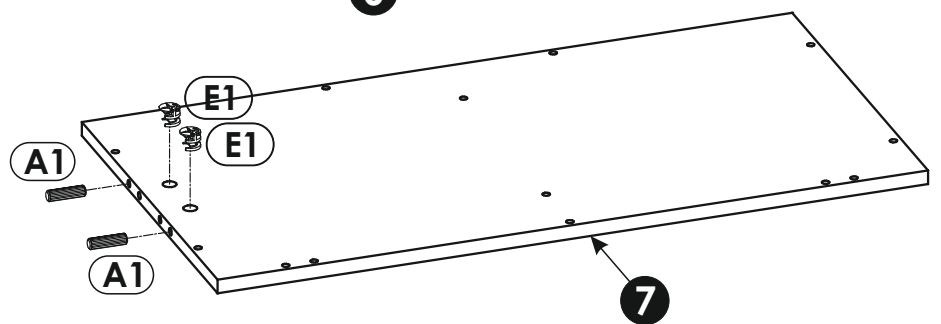
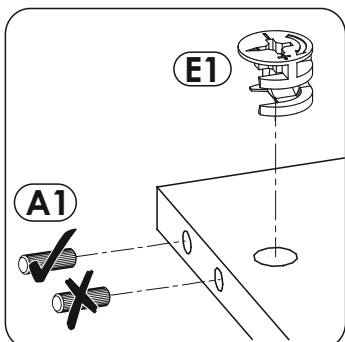
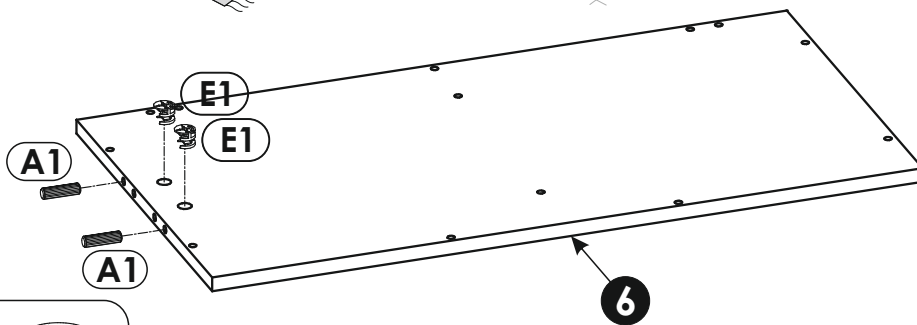
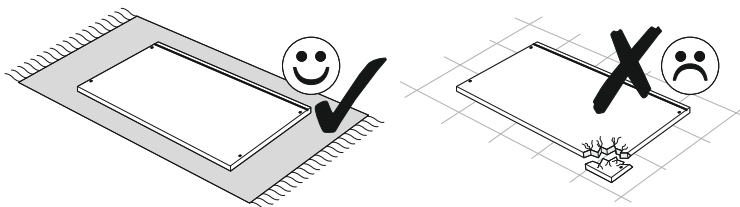

11 ▶

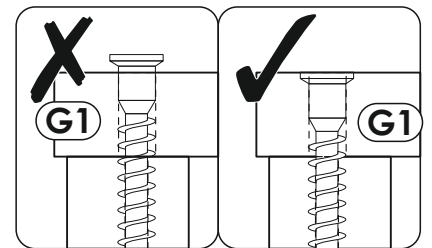
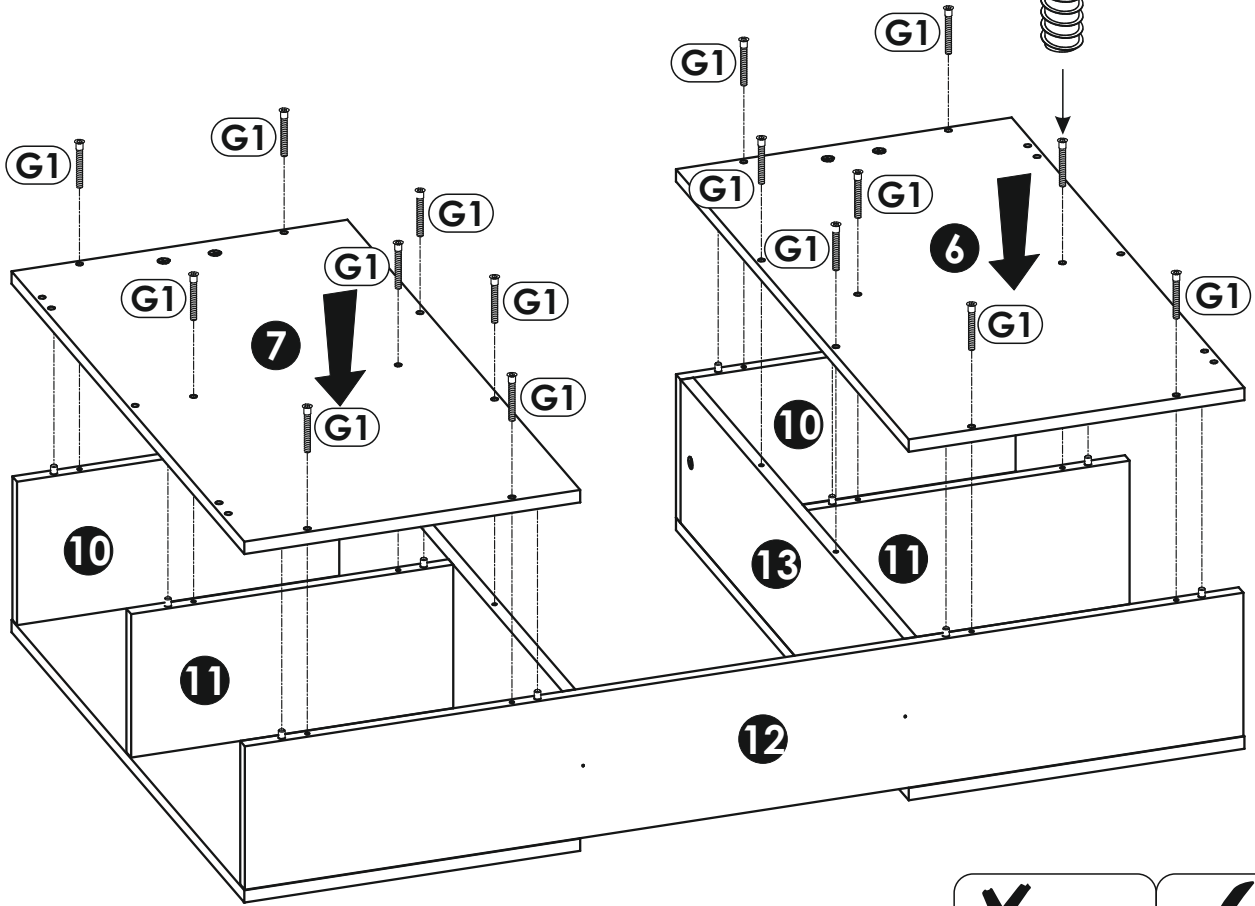
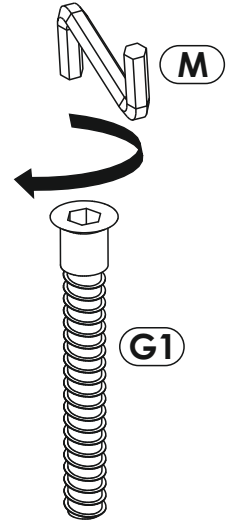
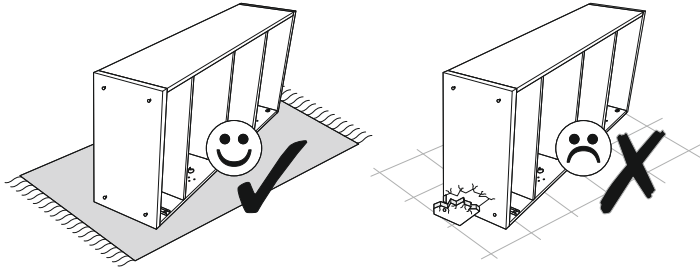

12 ▶

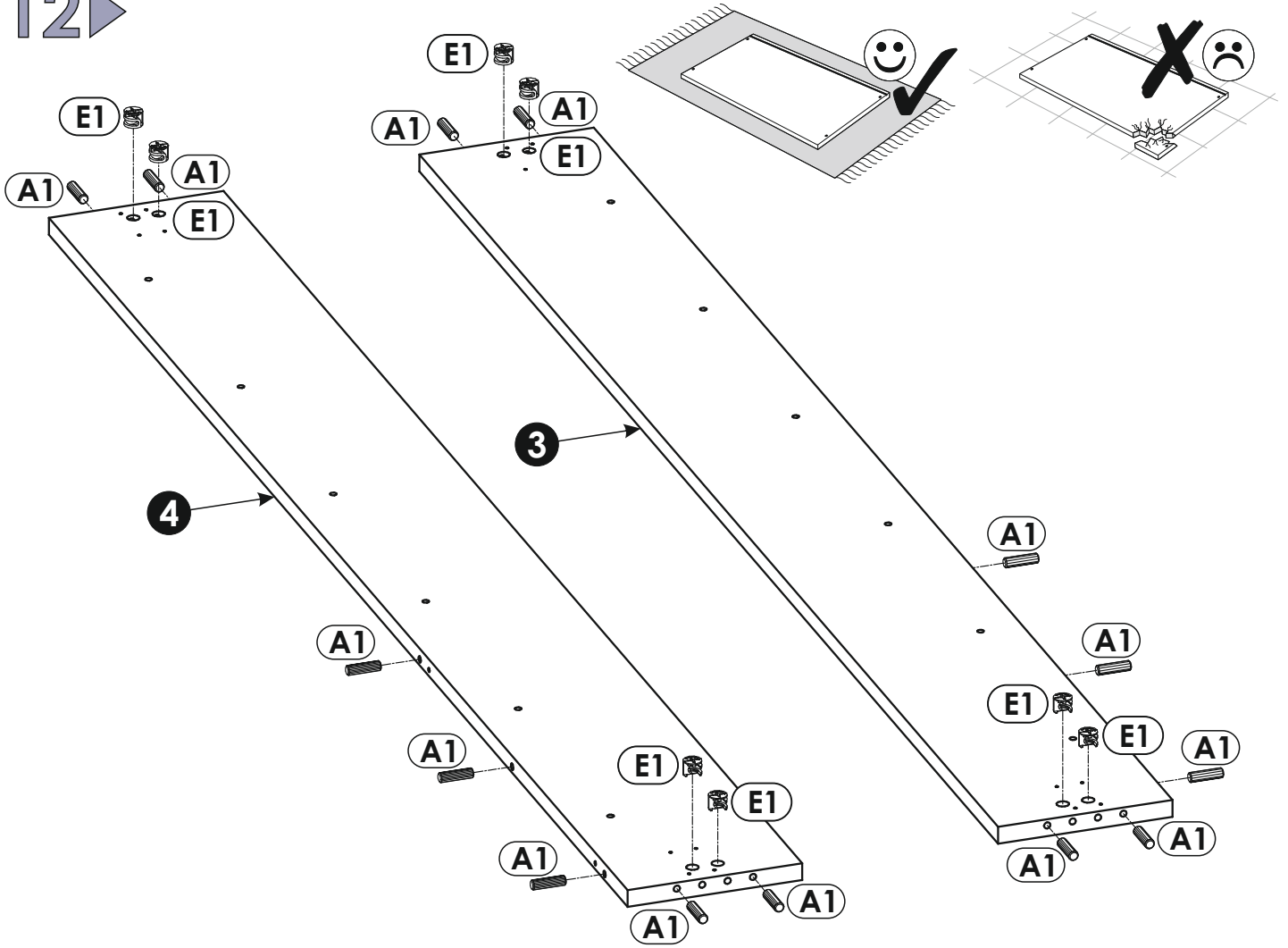

13 ▶

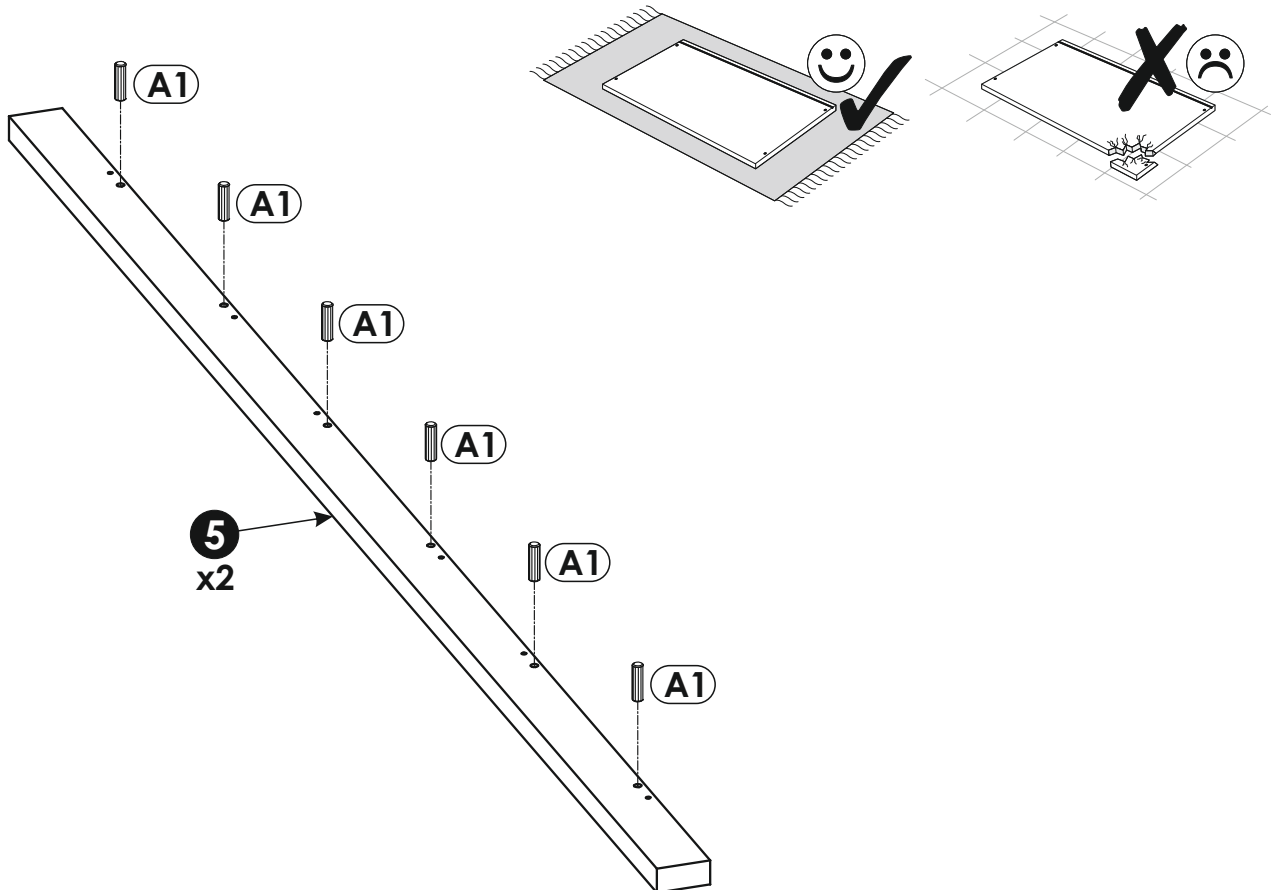

14 ▶

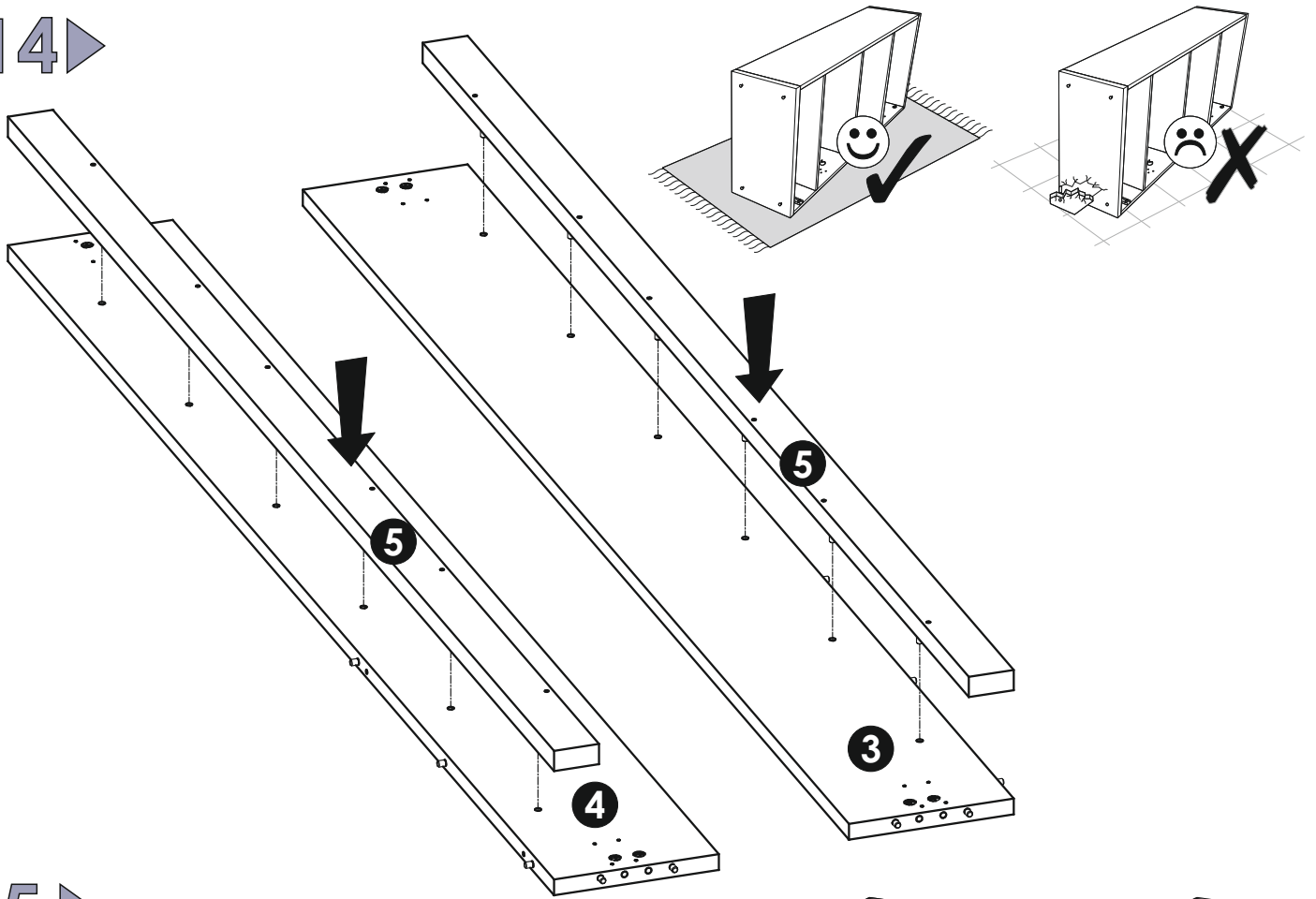

15 ▶

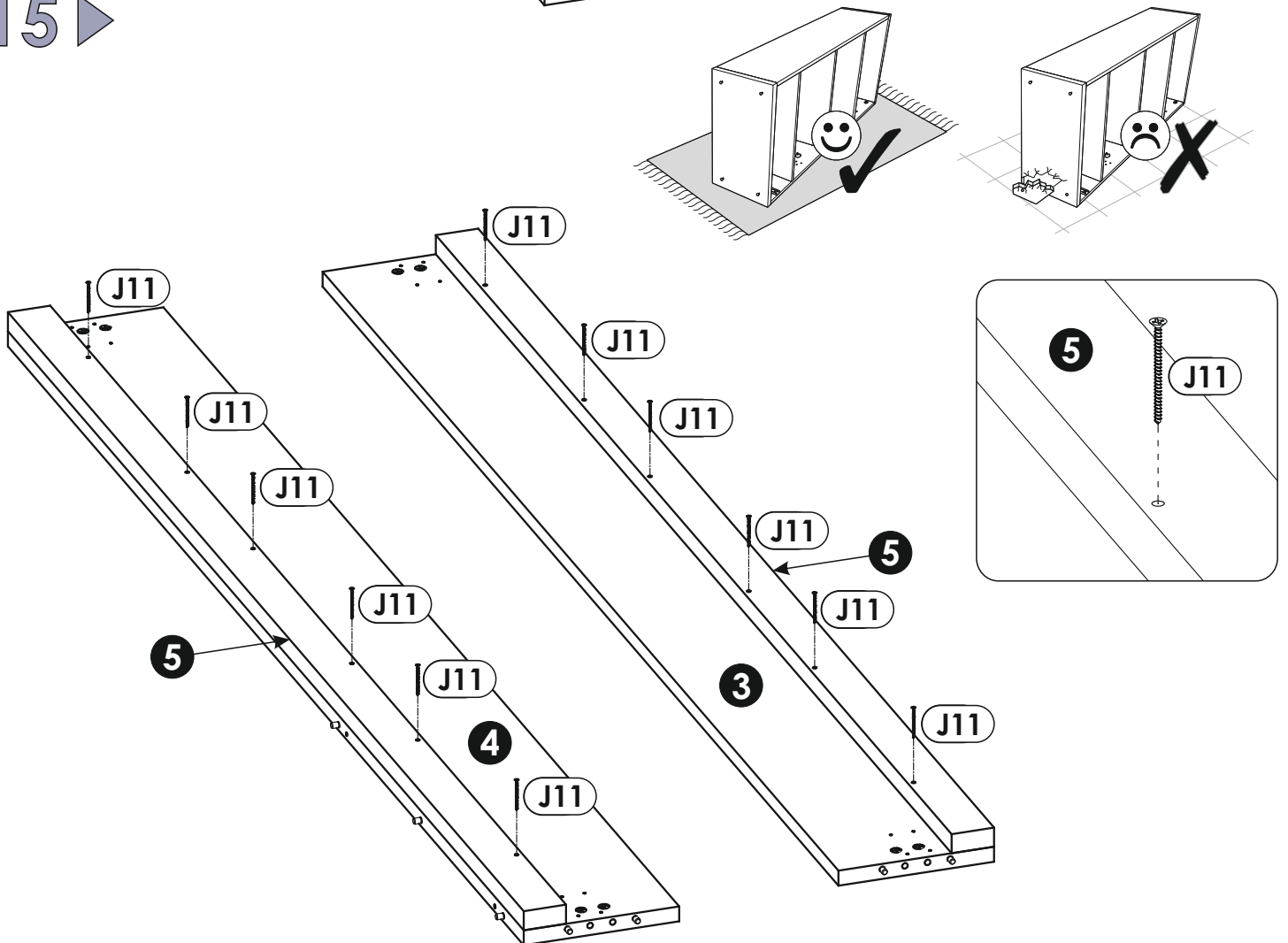

16▶

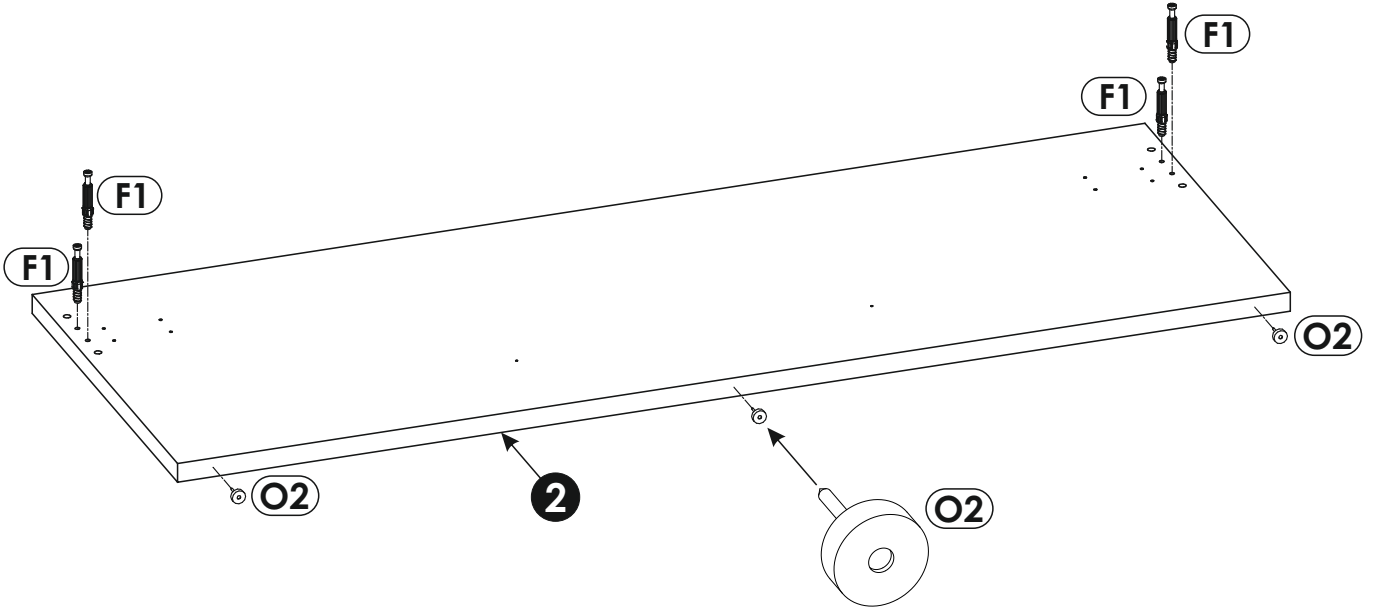
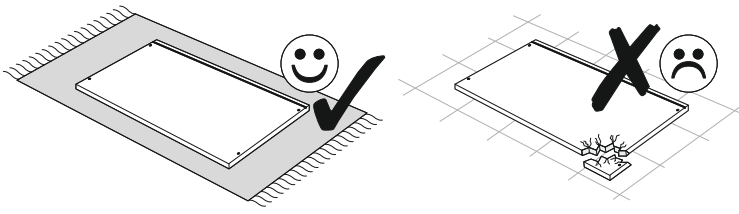

17▶

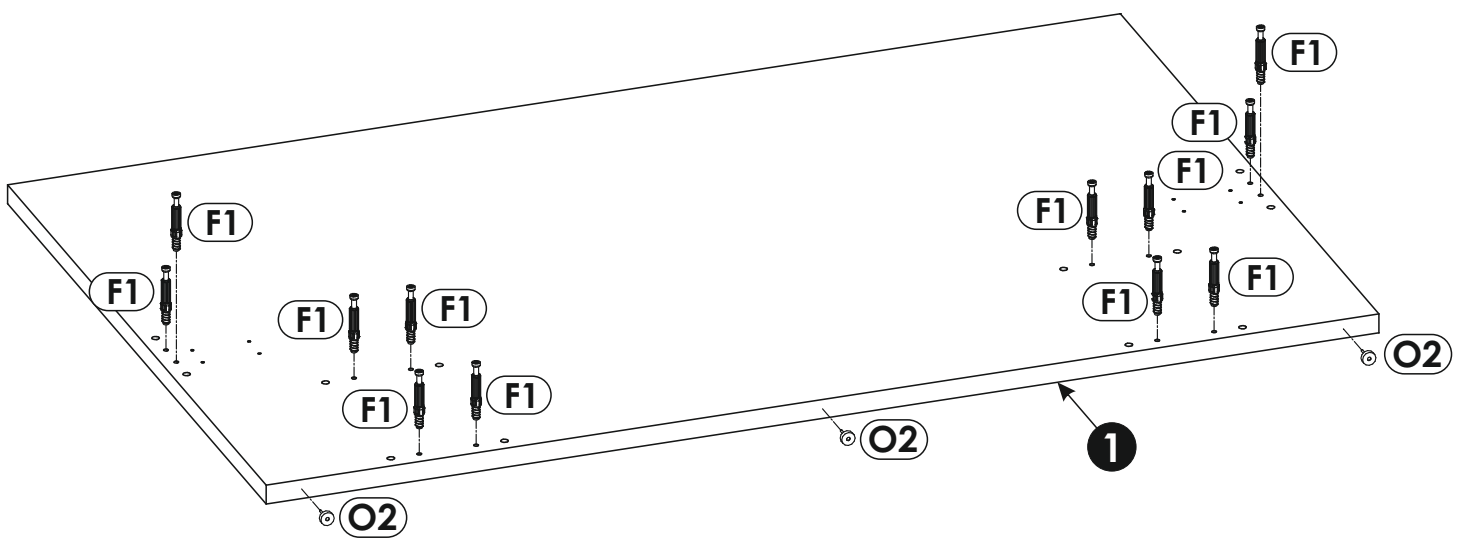
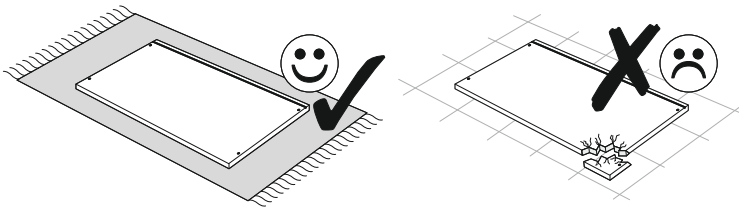

18 ▶

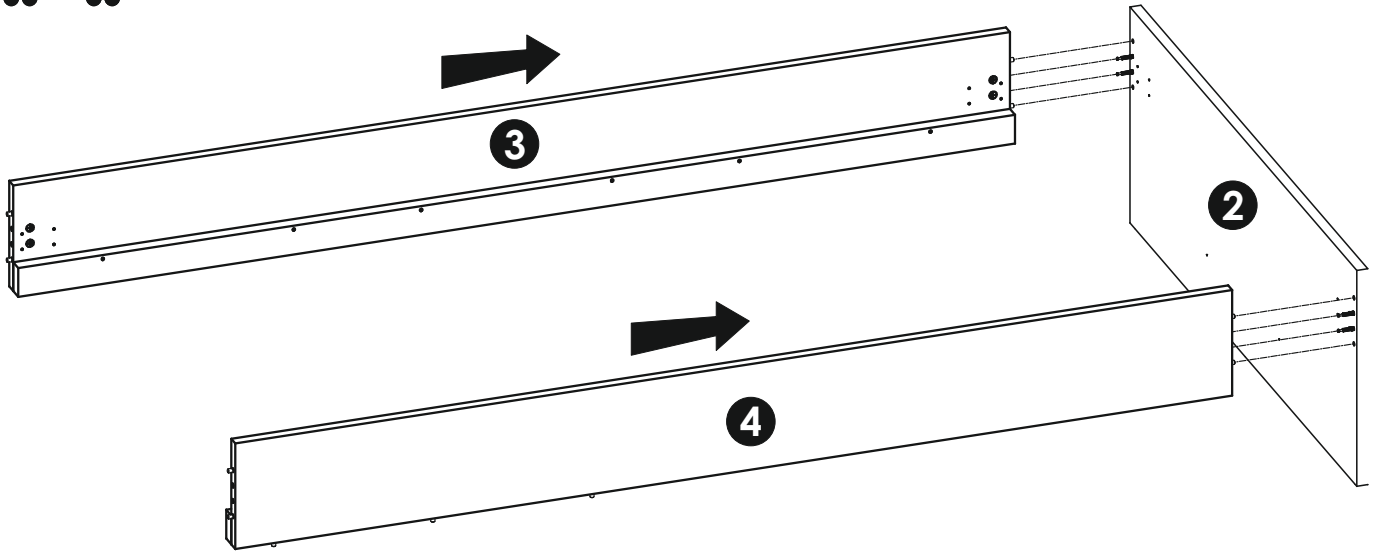
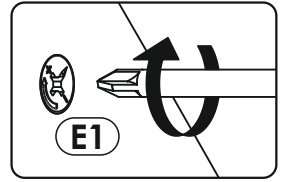
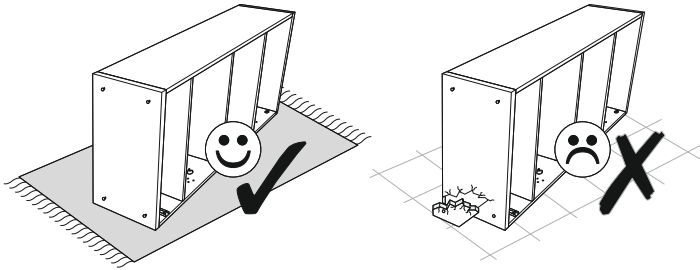

19 ▶

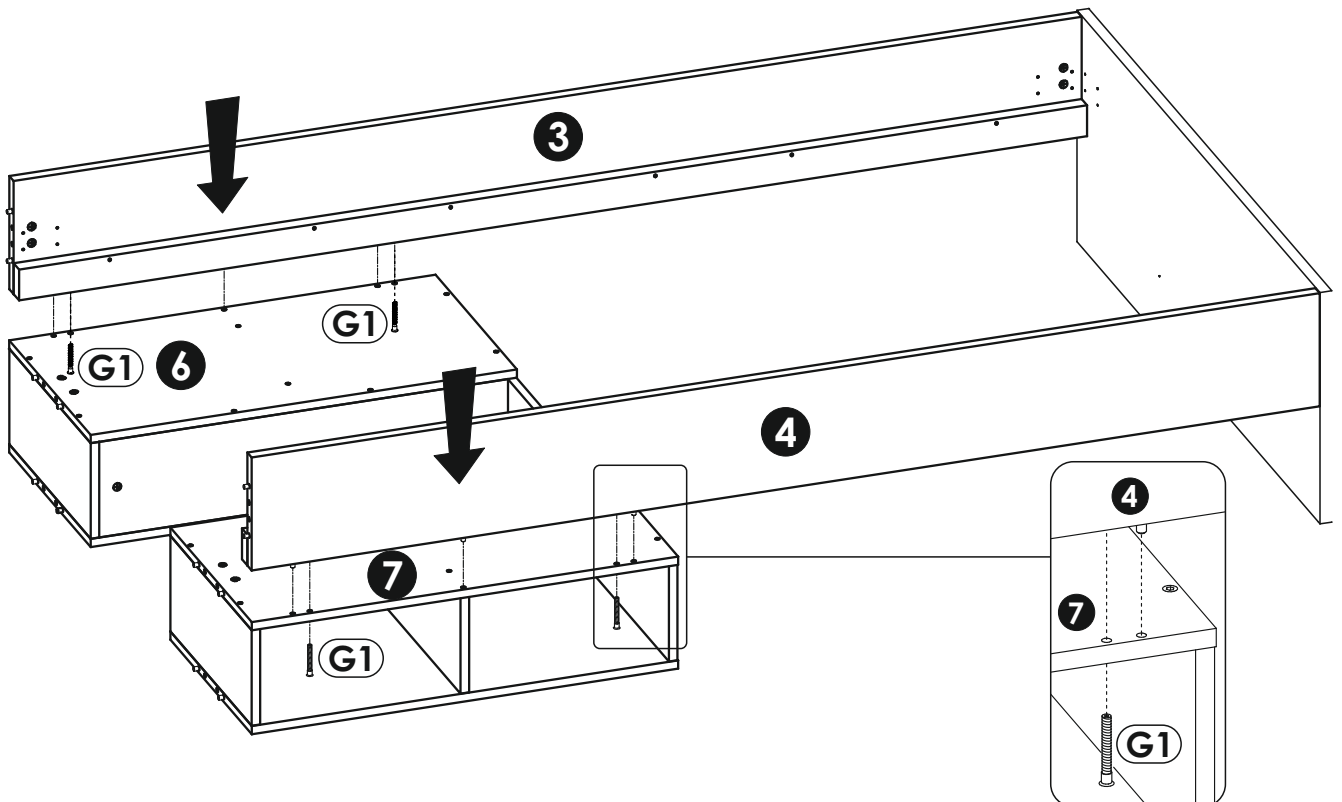
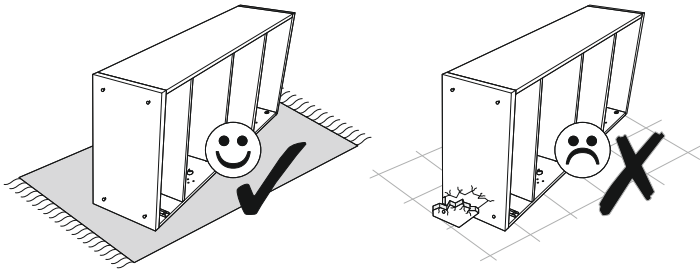
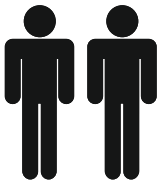

20 ▶

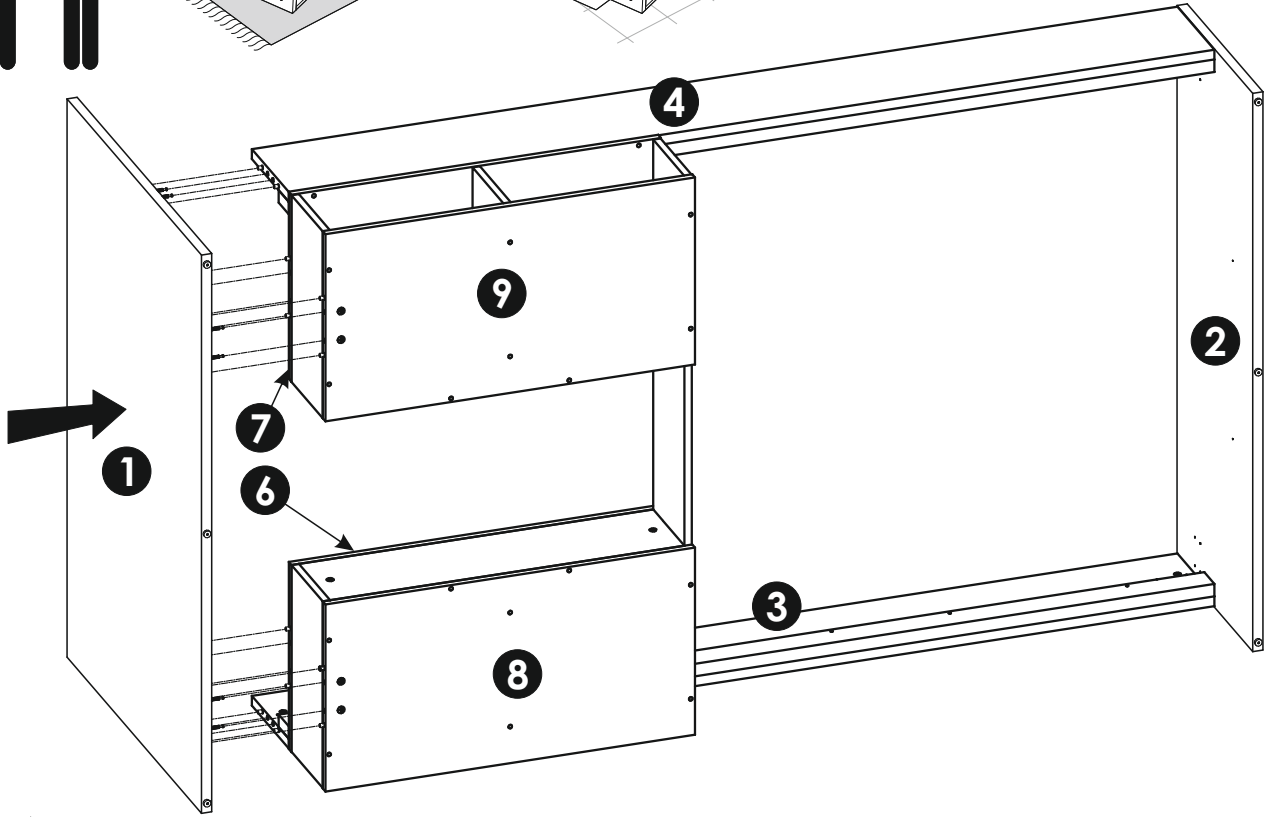
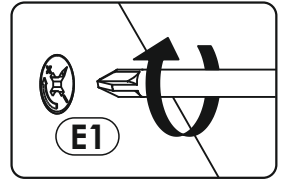
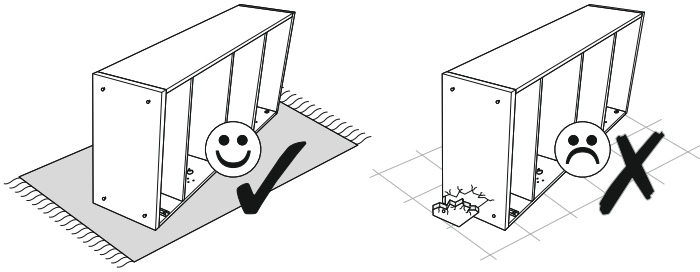
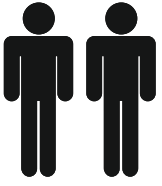

21 ▶

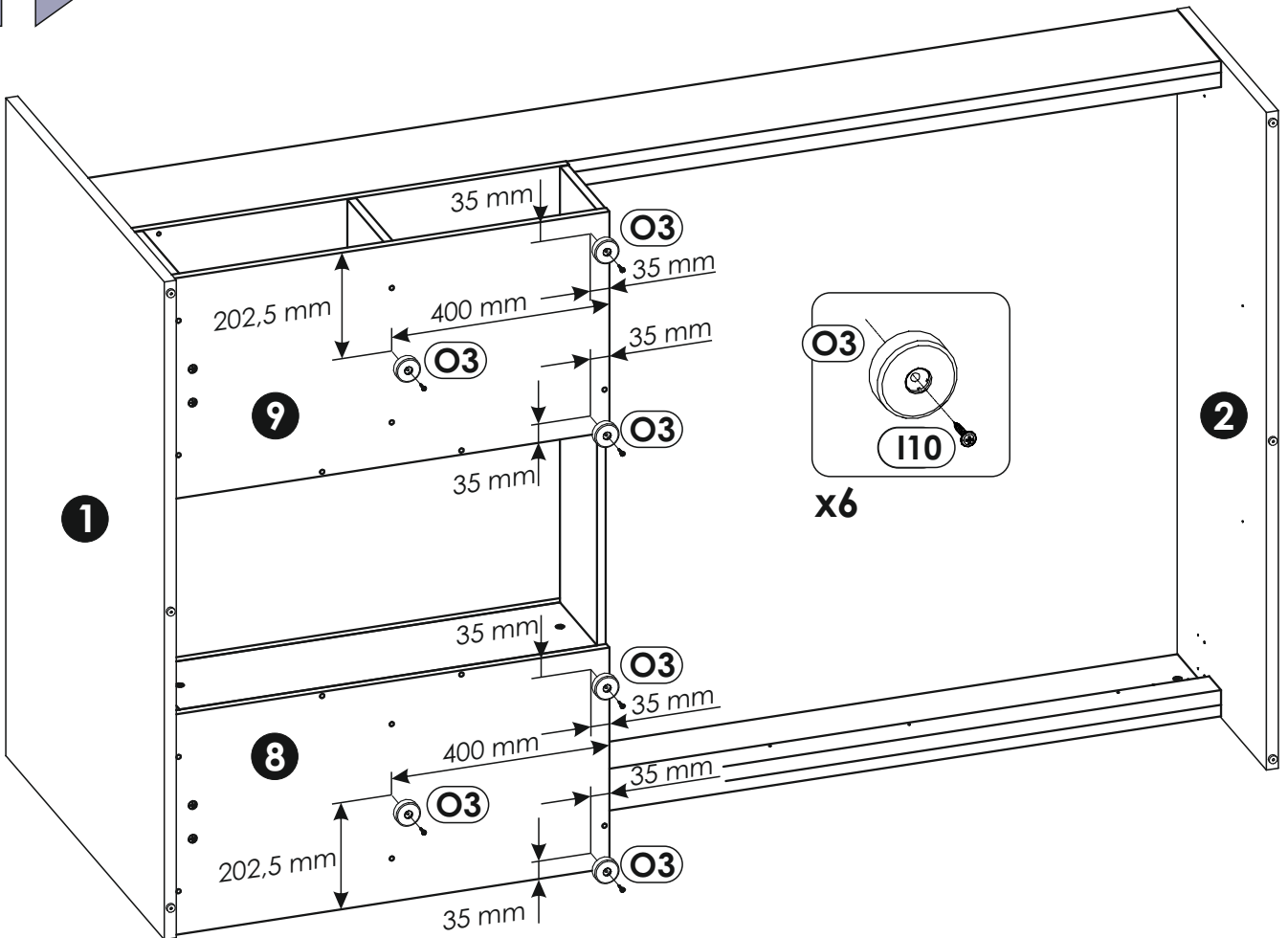

22 ▶

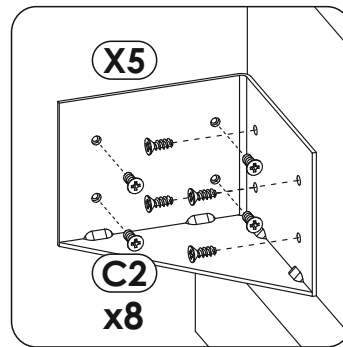
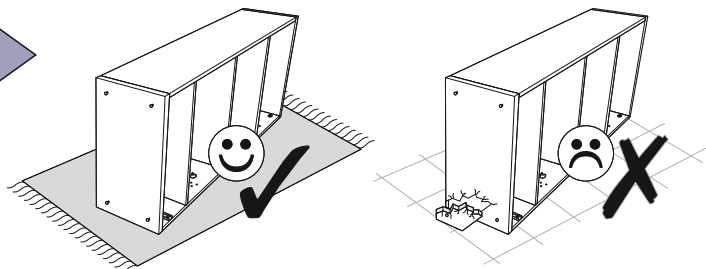

x4

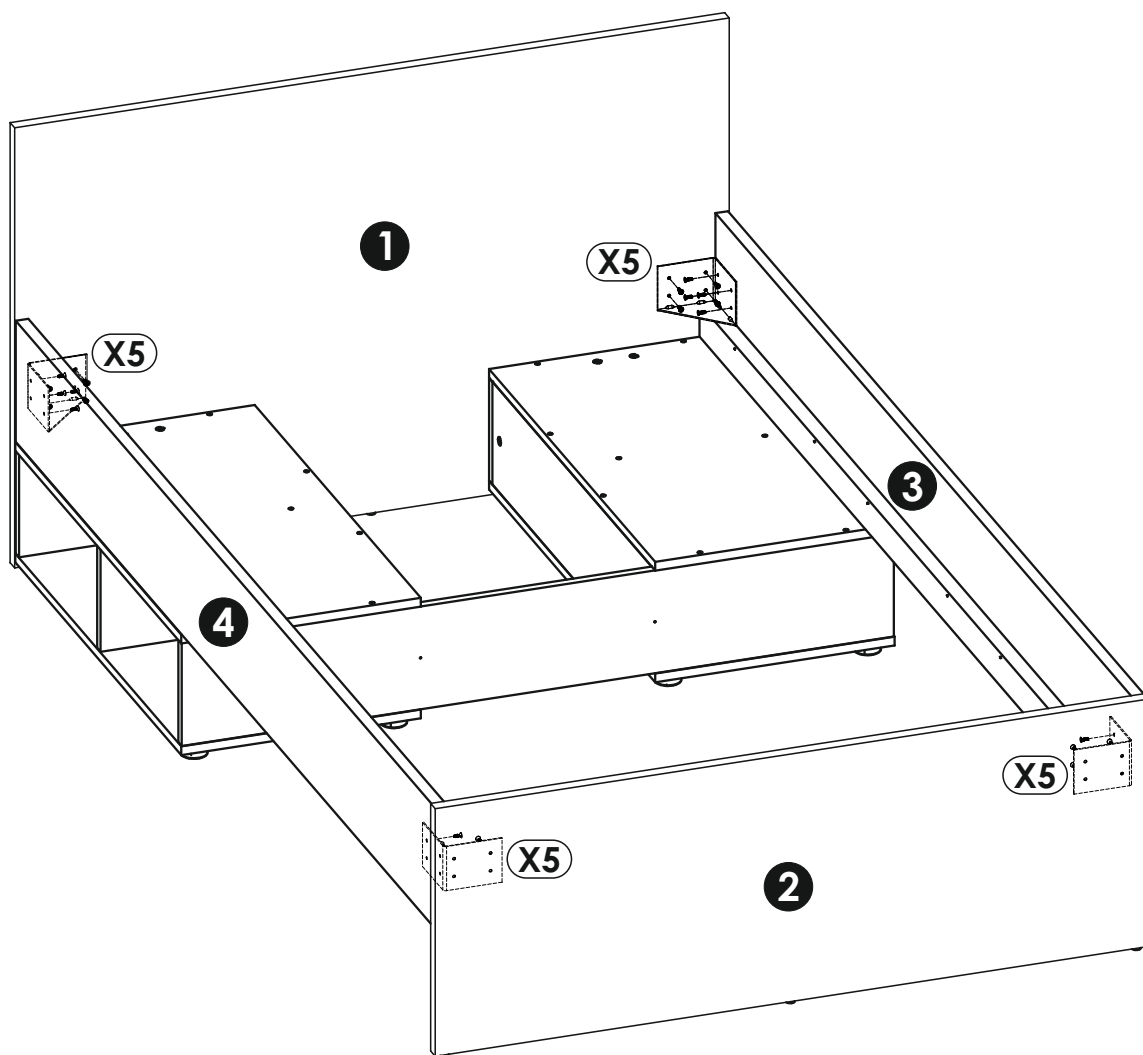



23 ▶

