











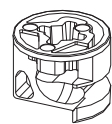



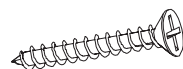

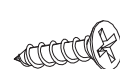

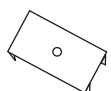
<b>K1</b> x 20 	<b>GW1</b> x 70 	<b>B2</b> x 16 
<b>ZM1</b> x 16 	<b>ZS1</b> x 4 	<b>ZJ1</b> x 16 
<b>WT22</b> x 4 4x35 	<b>WE2</b> x 12 6,3x13B 	<b>WT1</b> x 16 3,5x15 
<b>PO2</b> x 16 	<b>BR1</b> x 10 	<b>SG1</b> x 6 
<b>UBO</b> x 2 	<b>ZP9</b> x 6 	<b>KL</b> x 1 
<b>PK4</b> x 6 H-4 	<b>D19</b> x 1 L- 368 	<b>???</b> x 2 

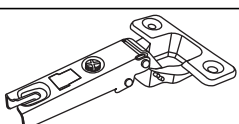
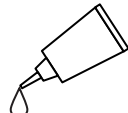
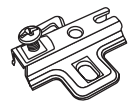

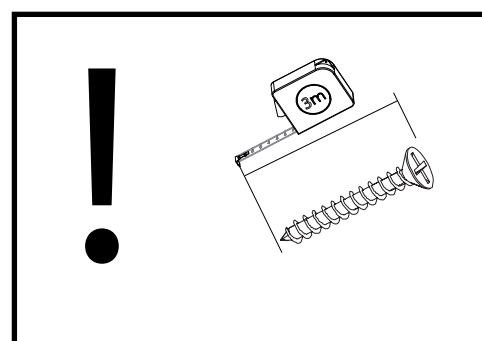
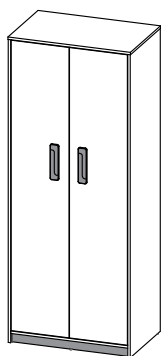

	CODE			
1	IQ02KHDF_01	1916	396	2
2	IQ02K_09	1882	378	2
3	IQ02K_07	460	373	4
4	IQ02K_03	1964	519	1
5	IQ02K_04	1964	519	1
6	IQ02W_01	765	60	1
7	IQ02K_06	1547	500	1
8	IQ02K_05	765	501	1
9	IQ02K_02	765	518	1
10	IQ02K_01	800	520	1
11	IQ02K_08	765	60	1

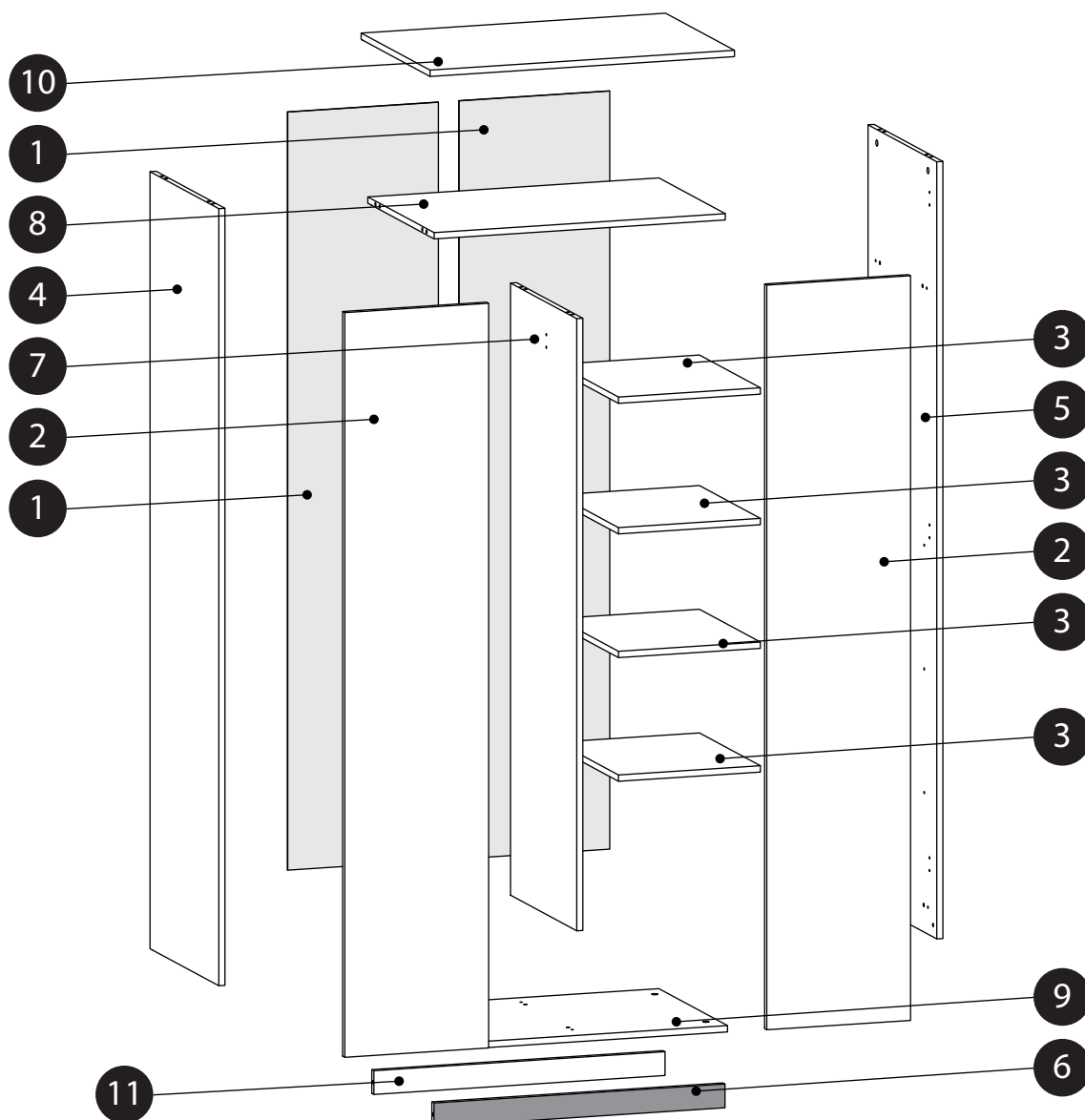

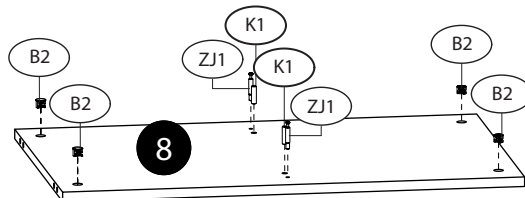
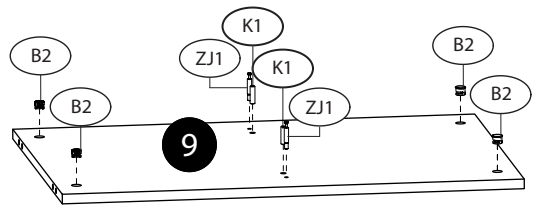
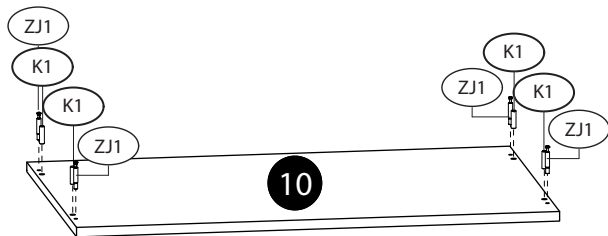
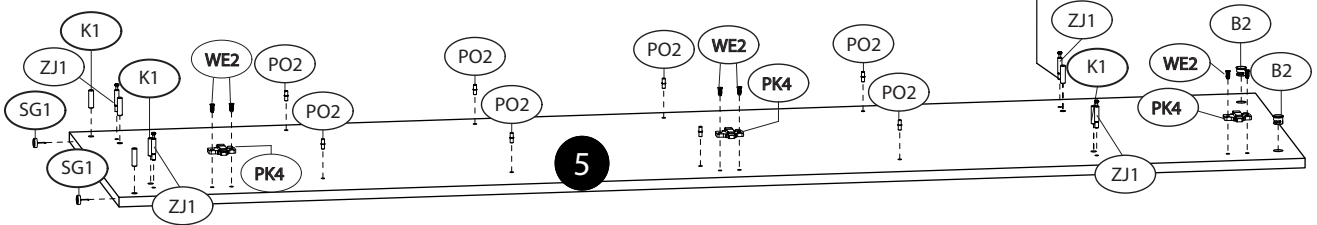
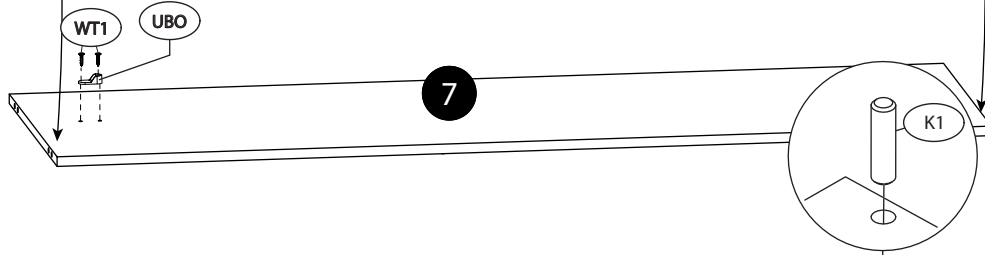
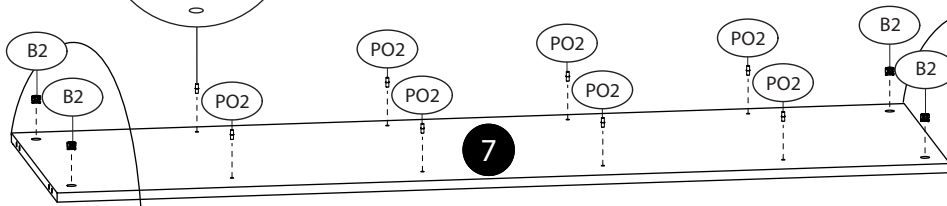
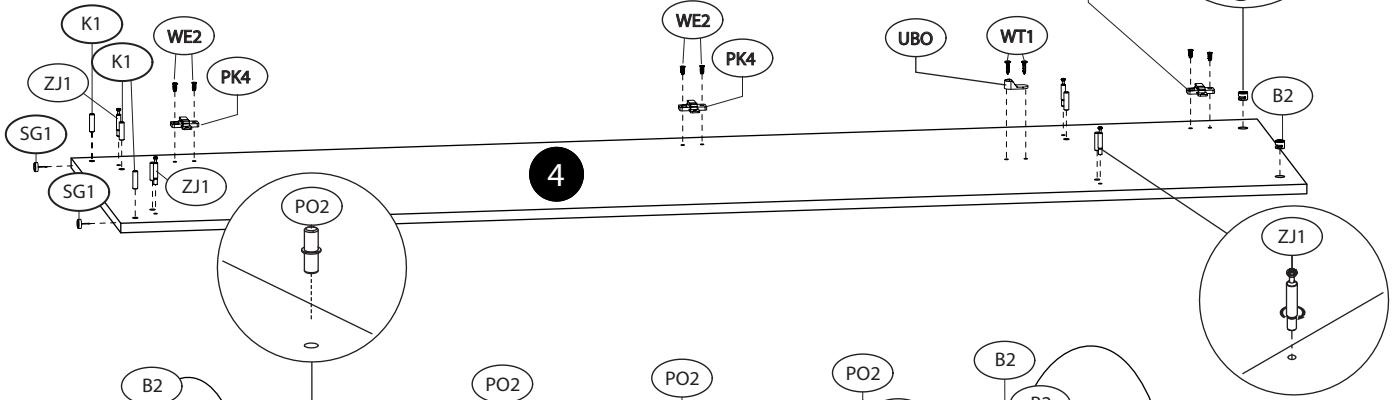
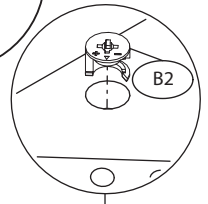
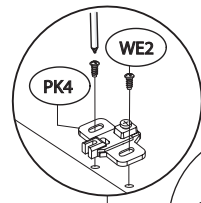
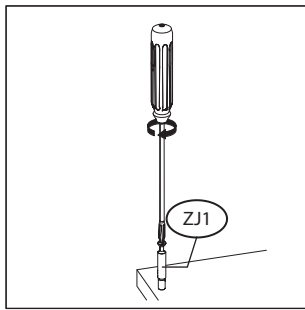
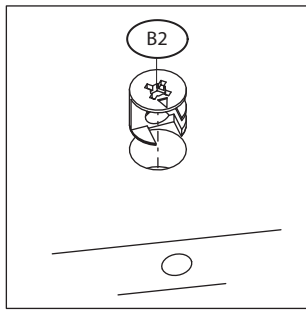
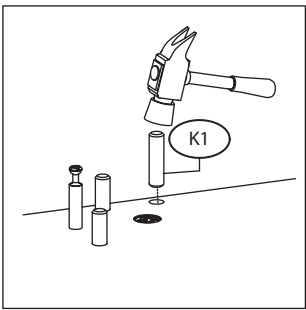

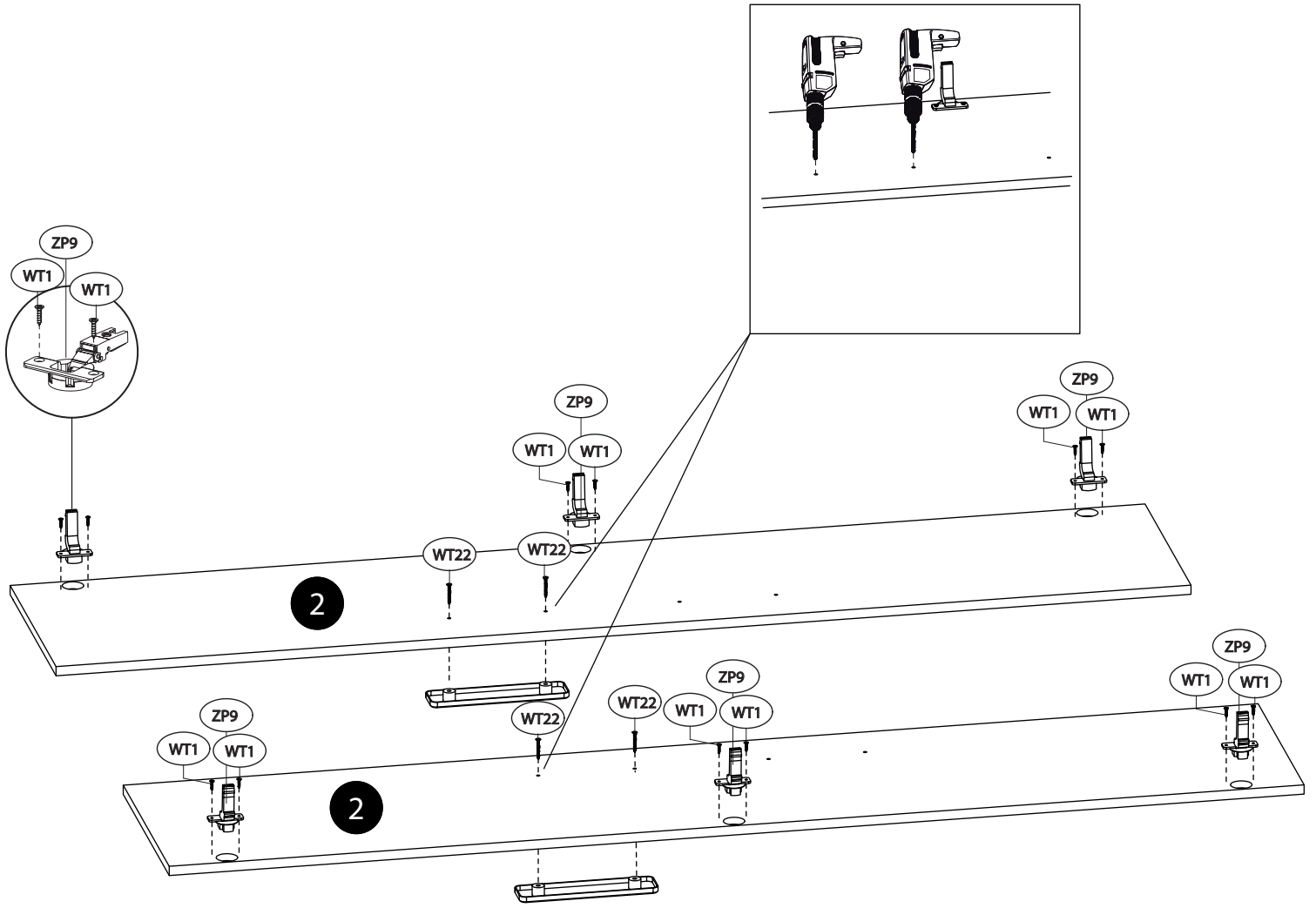

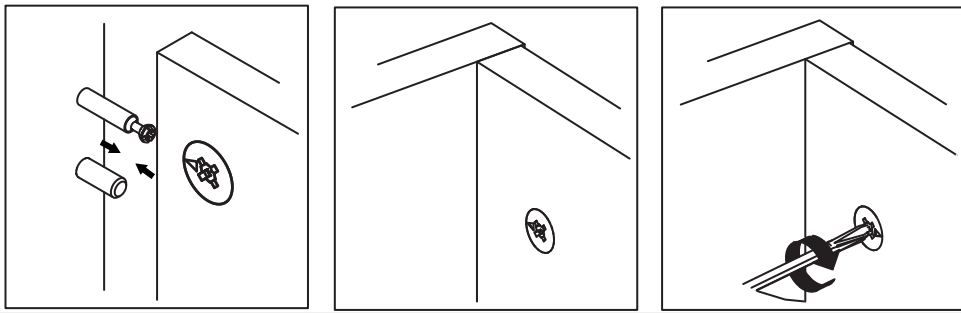

**A ▶**

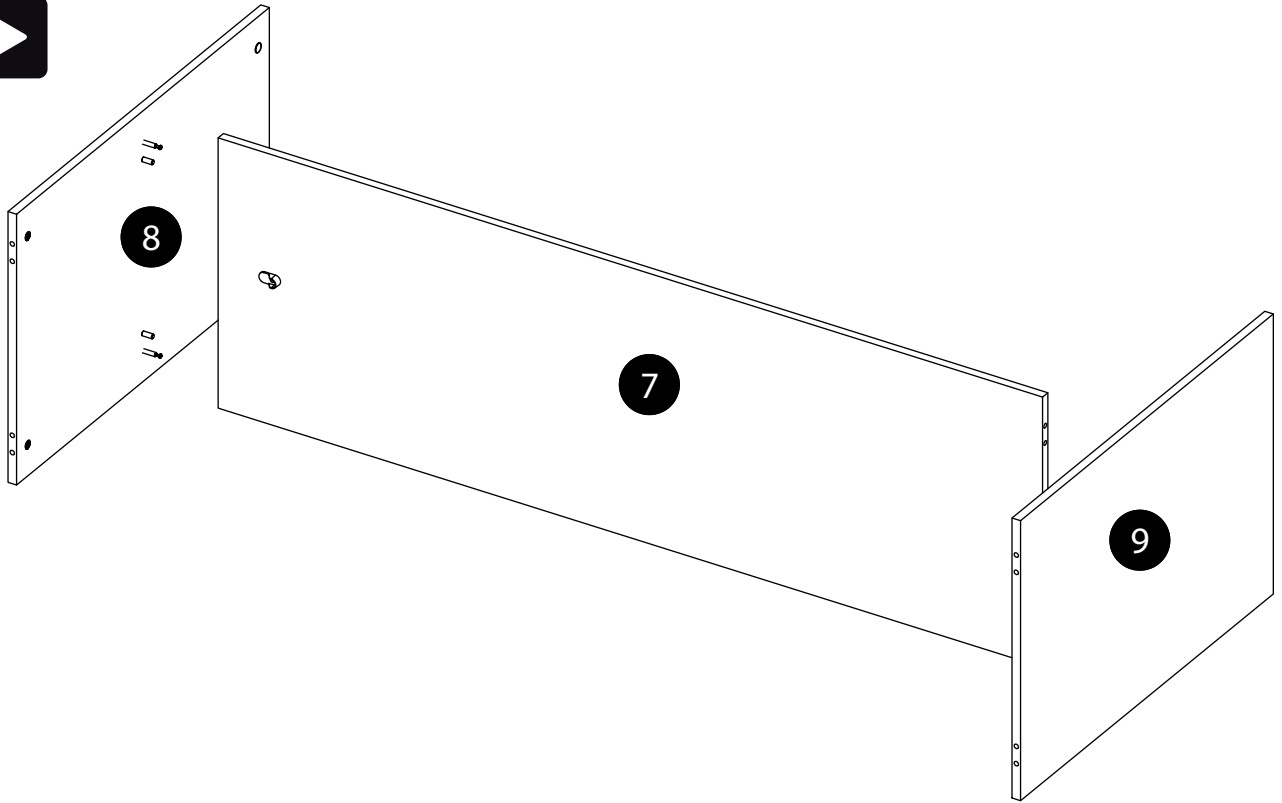

**B ▶**

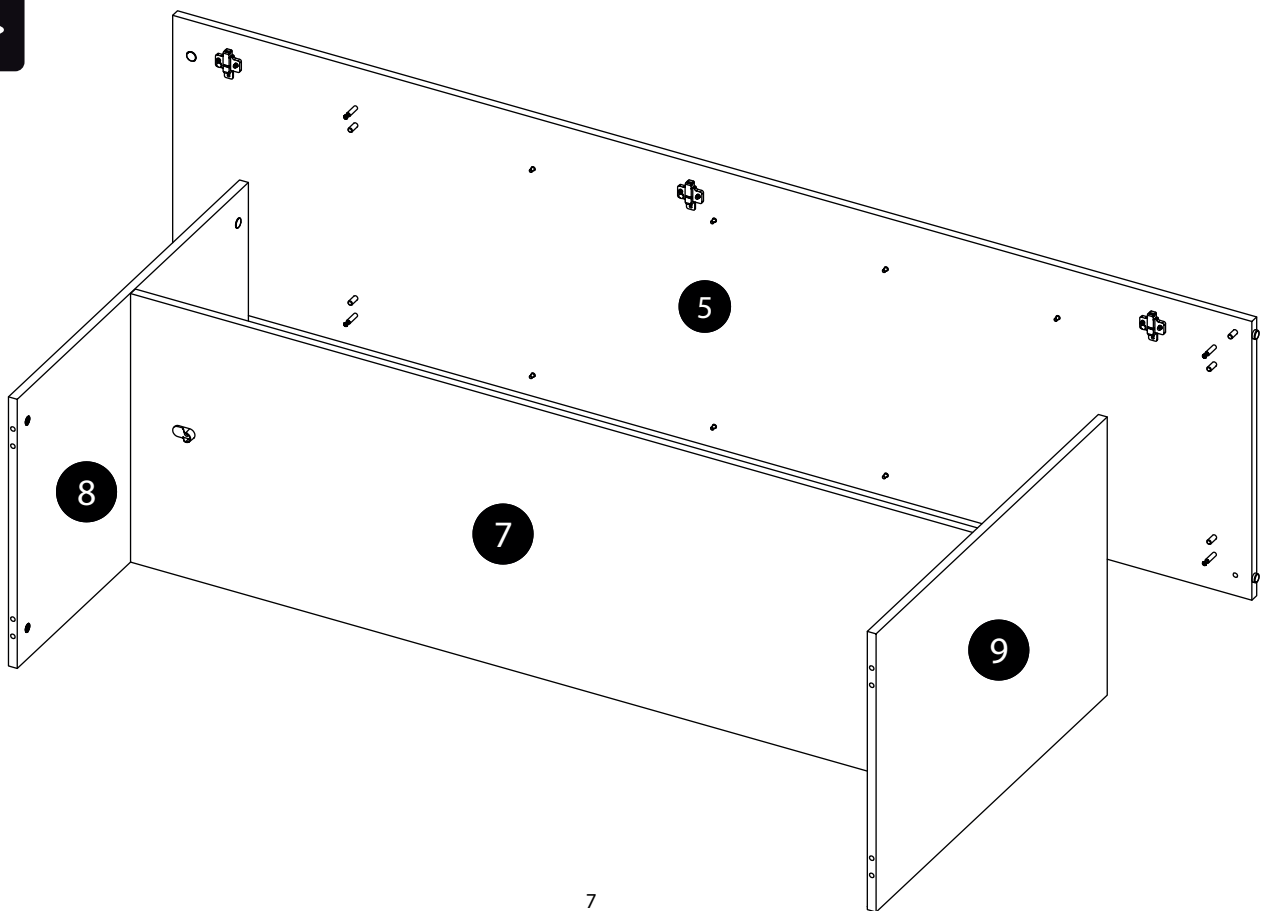

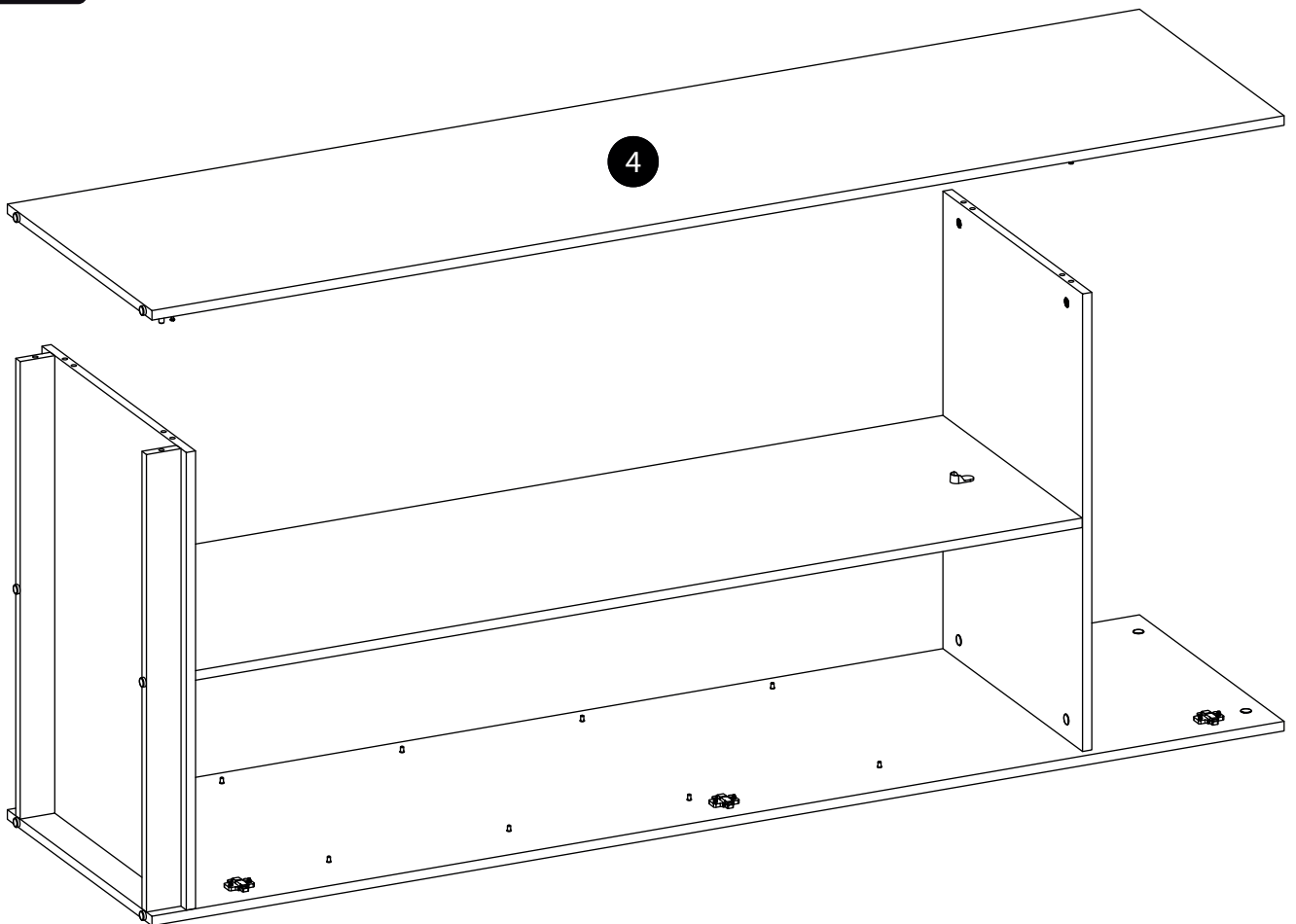
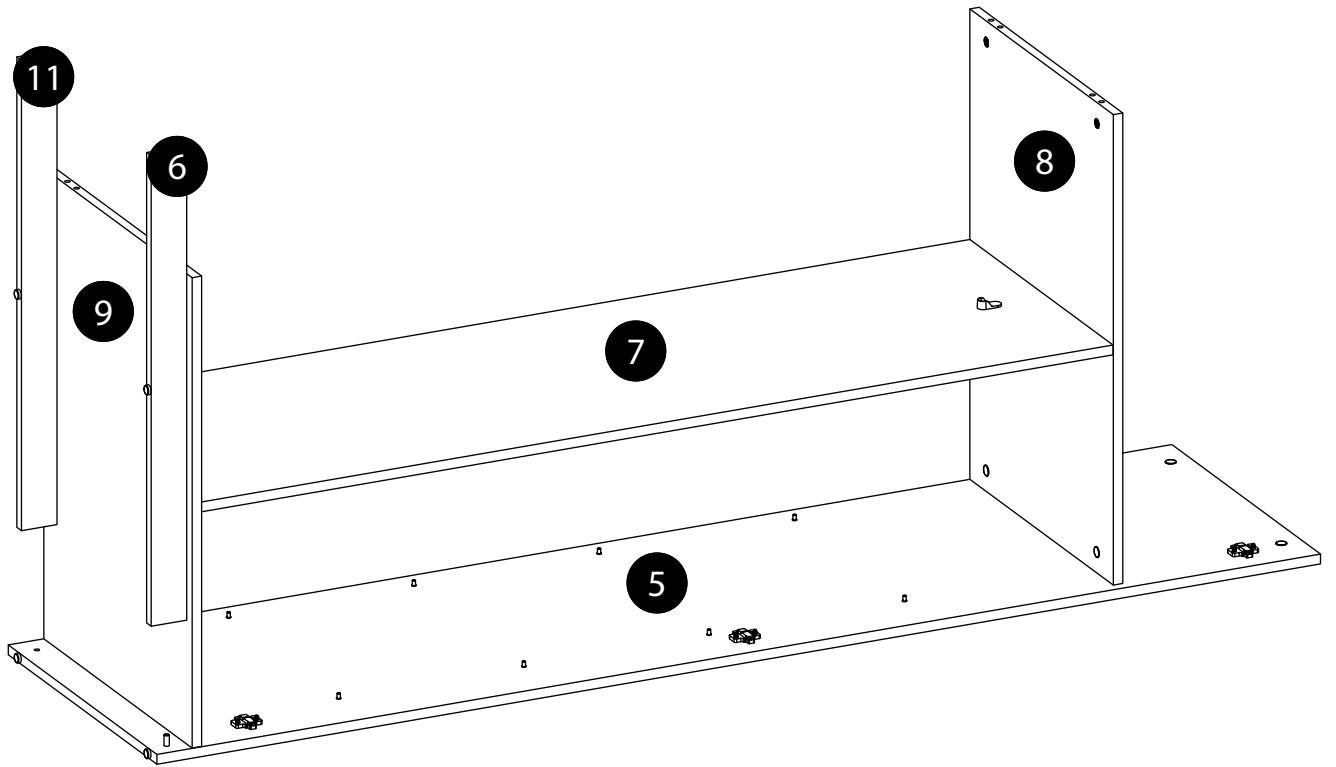



**E** ▶

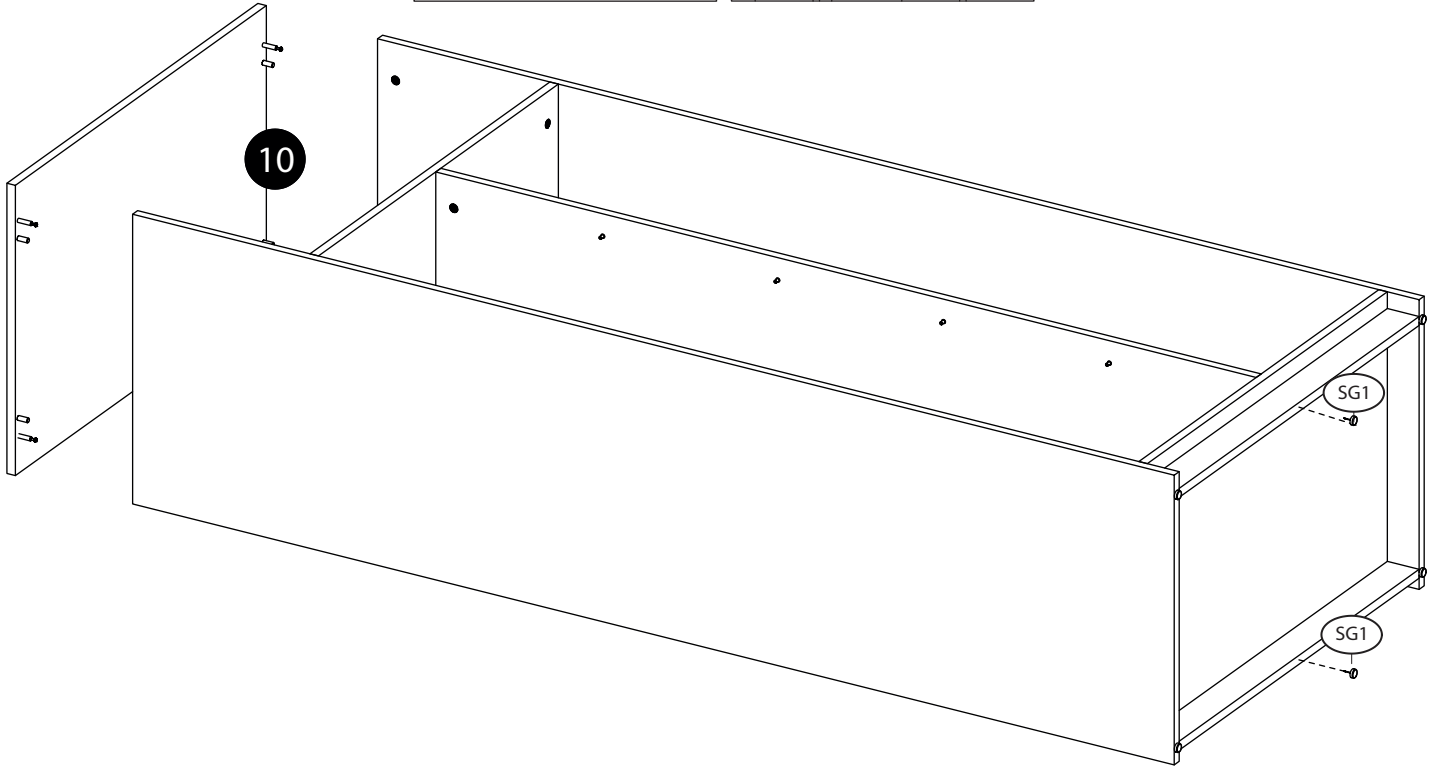
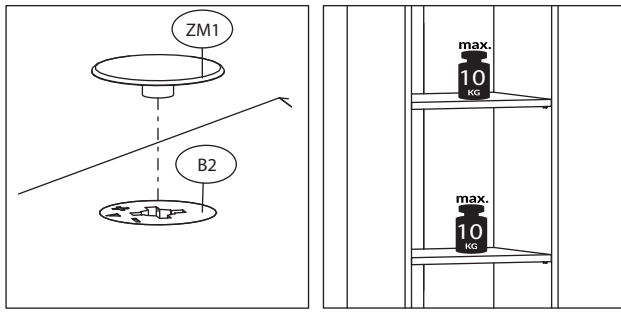

**F** ▶

