

Modellname: **CLIP**
Nazwa modelu:

Modellreihe: **S4 GL 1C 32**
Numer modelu:

Blatt Nr **1** von: **2**
Strona **1** z: **2**



2 Personen.

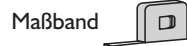
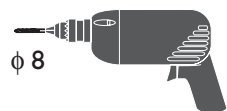
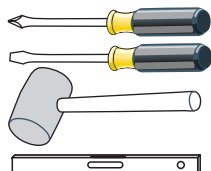

MONTAGEANLEITUNG INSTRUKCJA MONTAŻOWA



Max. 7 kg

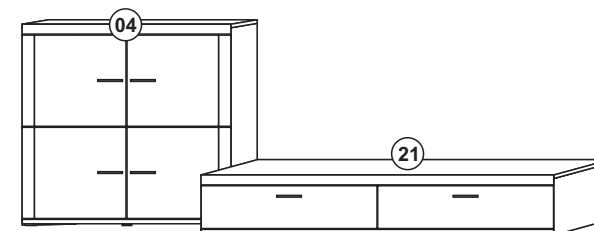
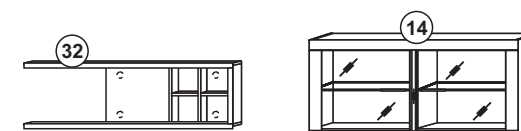
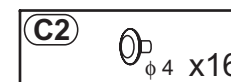
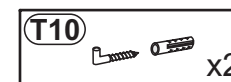
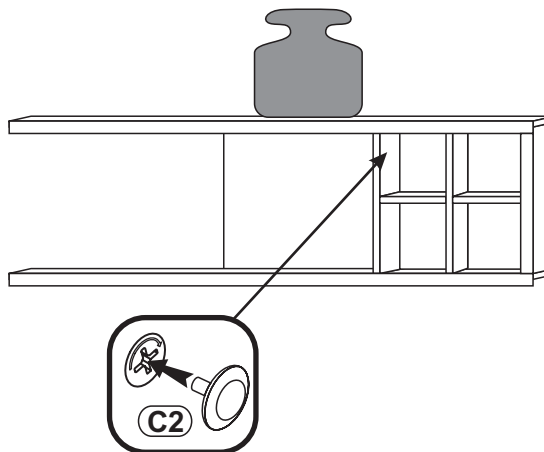

Pflegehinweis!

Bitte nur mit einem Staubtuch oder einem feuchten Lappen reinigen.

KEINE scheuernde Putzmittel verwenden!

Wskazówka dotycząca pielęgnacji!

Proszę czyścić tylko suchą lub lekko wilgotną szmatką do kurzu. Nie używać żadnych środków szorstkich!

1

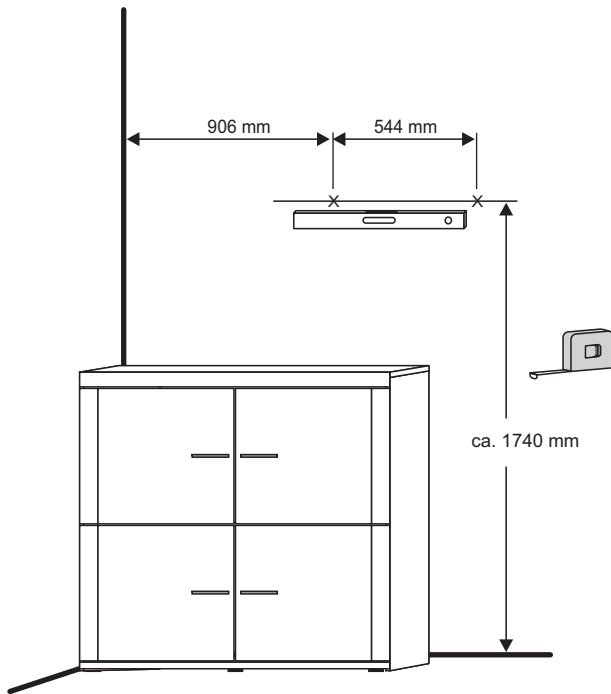
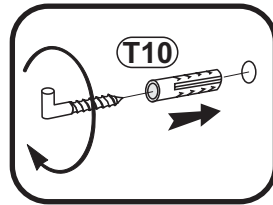
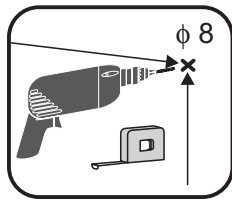
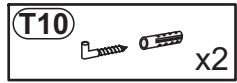

2

