



www.MLMEBLE.pl

GB

D

CZ

SK

RUS

LT

assembly instructions / montageanleitung / montážní návod / montážny návod / инструкции по монтажу / surinkimo instrukcija





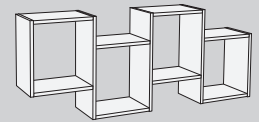

INSTRUKCJA MONTAŻU

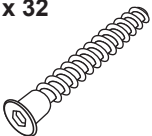

PORTO 07

↑ 50 → 125 ↗ 23

akcesoria / accessories / zubehör / příslušenství / prislušenstvo / аксессуары / furnitūra :

<p>x 32</p>  <p>KT 6,3/50</p>	<p>x 32</p>  <p>ZAK</p>	<p>x 10</p>  <p>WT 3x30</p>	<p>x 5</p>  <p>ZAM 13x60</p>	<p>x 1</p>  <p>kluczyk / key / schlüssel / klíč / kľúč / ключ / raktas</p>
---	---	---	--	--

do montażu potrzebne są:

are needed for assembly:
sind erforderlich für die montage:
jsou potřebné pro montáž:
sú potrebné pre montáž:
которые необходимы для сборки:
Surinkimui reikės

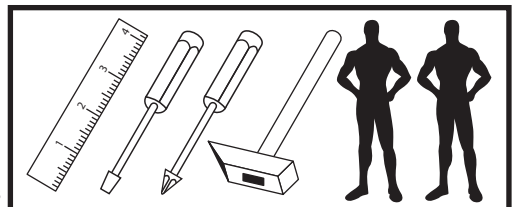

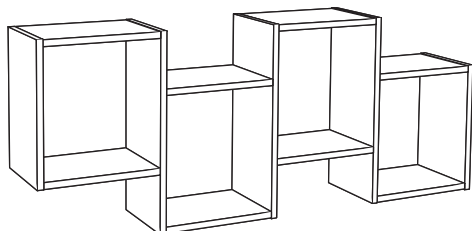

	CODE			
1	PORTO07_01	498	222	3
2	PORTO07_02	350	222	2
3	PORTO07_03	291	220	8
4				
5				
6				
7				

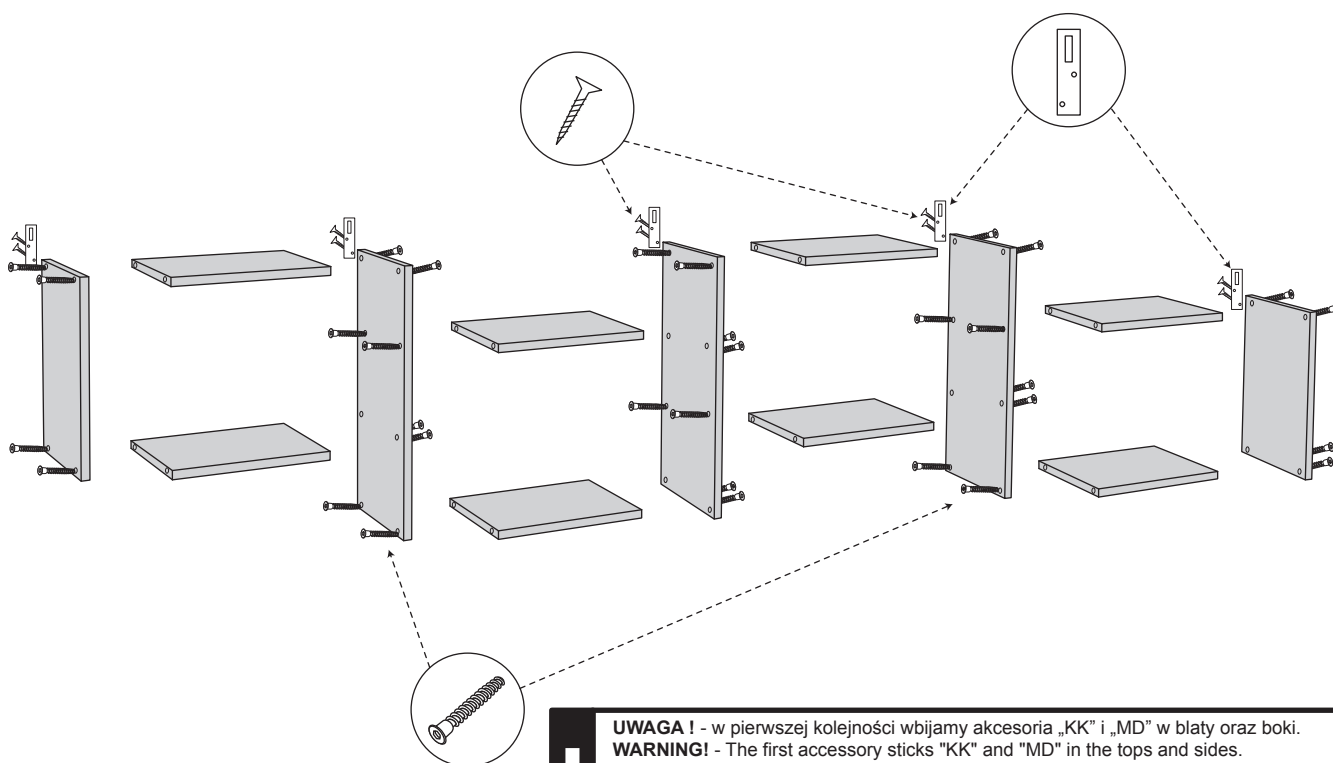
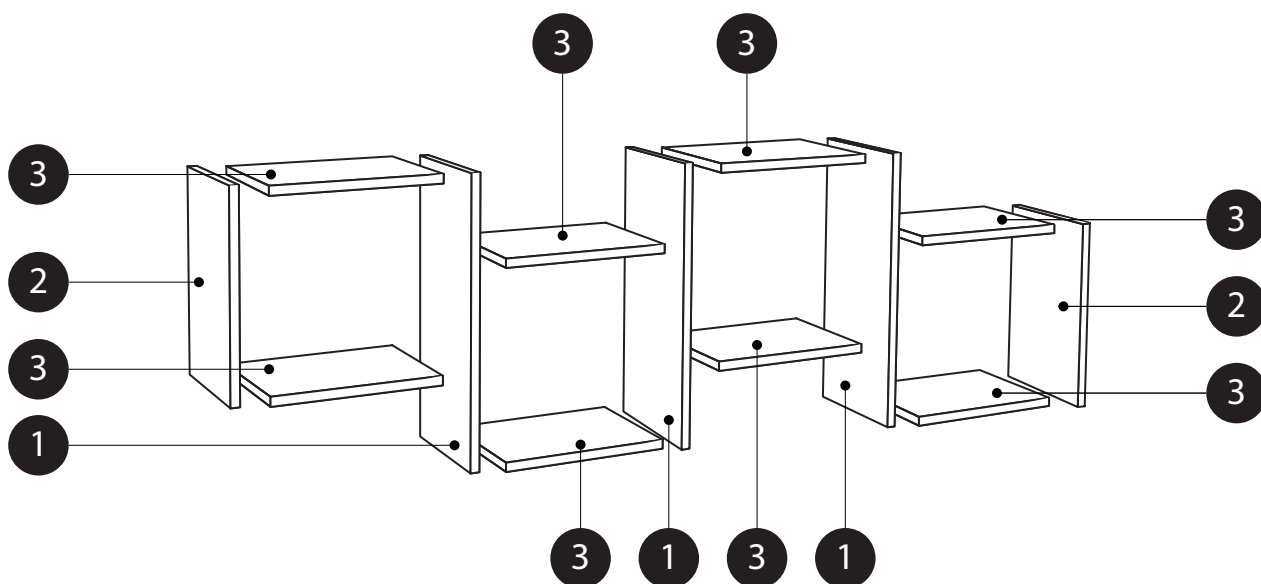

! UWAGA ! - w pierwszej kolejności wbijamy akcesoria „KK” i „MD” w blaty oraz boki.
! WARNING! - The first accessory sticks "KK" and "MD" in the tops and sides.
! POZOR! - Die erste Accessoire-Sticks "KK" und "MD" in den Spitzen und an den Seiten.
! POZOR! - První příslušenství holí "KK" a "MD" v korunách a boky.
! ПОЗОР! - Првѣ прїслушенство палїц "KK" a "MD" v korunách a boky.
! ДѐМЕСІО! - Pirmiausiai furnitūrą KK ir MD įkalame į stalviršį ir šonus.