



www.MLMEBLE.pl

GB

D

CZ

SK

RUS

LT

assembly instructions / montageanleitung / montážní návod / montážny návod / инструкции по монтажу / surinkimo instrukcija





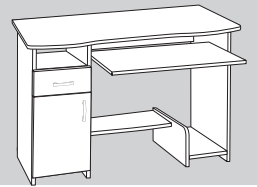





INSTRUKCJA MONTAŻU

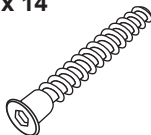

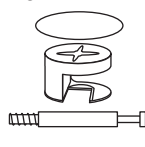
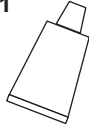
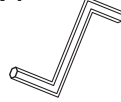
MIKOŁAJ

↑74 →102 ↗51

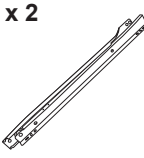
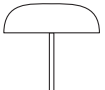
akcesoria / accessories / zubehör / příslušenství / prislušenstvo / аксессуары / furnitūra :

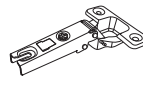
<p>x 22</p>  <p>KK 8/30</p>	<p>x 14</p>  <p>KT 6,3/50</p>	<p>x 9</p>  <p>ZAK</p>	<p>x 3</p>  <p>MD</p>	<p>x 1</p>  <p>klej / glue / kleber / lepidlo / lepidlo / клей / kljaj</p>	<p>x 1</p>  <p>kluczyk / key / schlüssel / klíč / kľúč / ключ / raktas</p>	<p>x 28</p>  <p>WT 3,5x16</p>	<p>x 4</p>  <p>WT 4x35</p>
<p>x 30</p>  <p>GZ 1/10</p>	<p>x 4</p>  <p>WE 6,3x13</p>	<p>x 2</p>  <p>PAL300</p>	<p>x 8</p>  <p>SG 8/8</p>	<p>x 2</p>  <p>UT L96</p>	<p>x 2</p>  <p>PK H-0</p>	<p>x 2</p>  <p>ZA 110°</p>	

do montażu potrzebne są:
are needed for assembly:
sind erforderlich für die montage:
jsou potřebné pro montáž:
sú potrebné pre montáž:
которые необходимы для сборки:
Surinkimui reikės

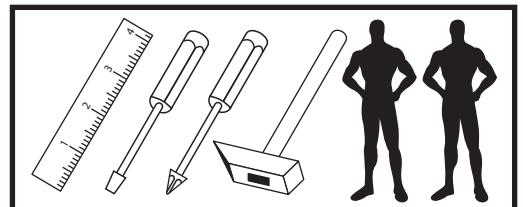

	CODE			
1	MIKOLAJ_01	1020	510	1
2	MIKOLAJ_02	720	405	1
3	MIKOLAJ_03	669	300	1
4	MIKOLAJ_04	456	60	1
5	MIKOLAJ_05	200	405	1
6	MIKOLAJ_06	250	404	2
7	MIKOLAJ_07	220	404	1
8	MIKOLAJ_08	410	280	1
9	MIKOLAJ_09	280	130	1
10	MIKOLAJ_10	300	80	2
11	MIKOLAJ_11	189	80	1
12	MIKOLAJ_12	456	252	1
13	MIKOLAJ_13	720	405	1
14	MIKOLAJ_14	720	405	1
15	MIKOLAJHDF_01	675	283	1

	CODE			
16	MIKOLAJHDF_02	307	220	1
17				
18				

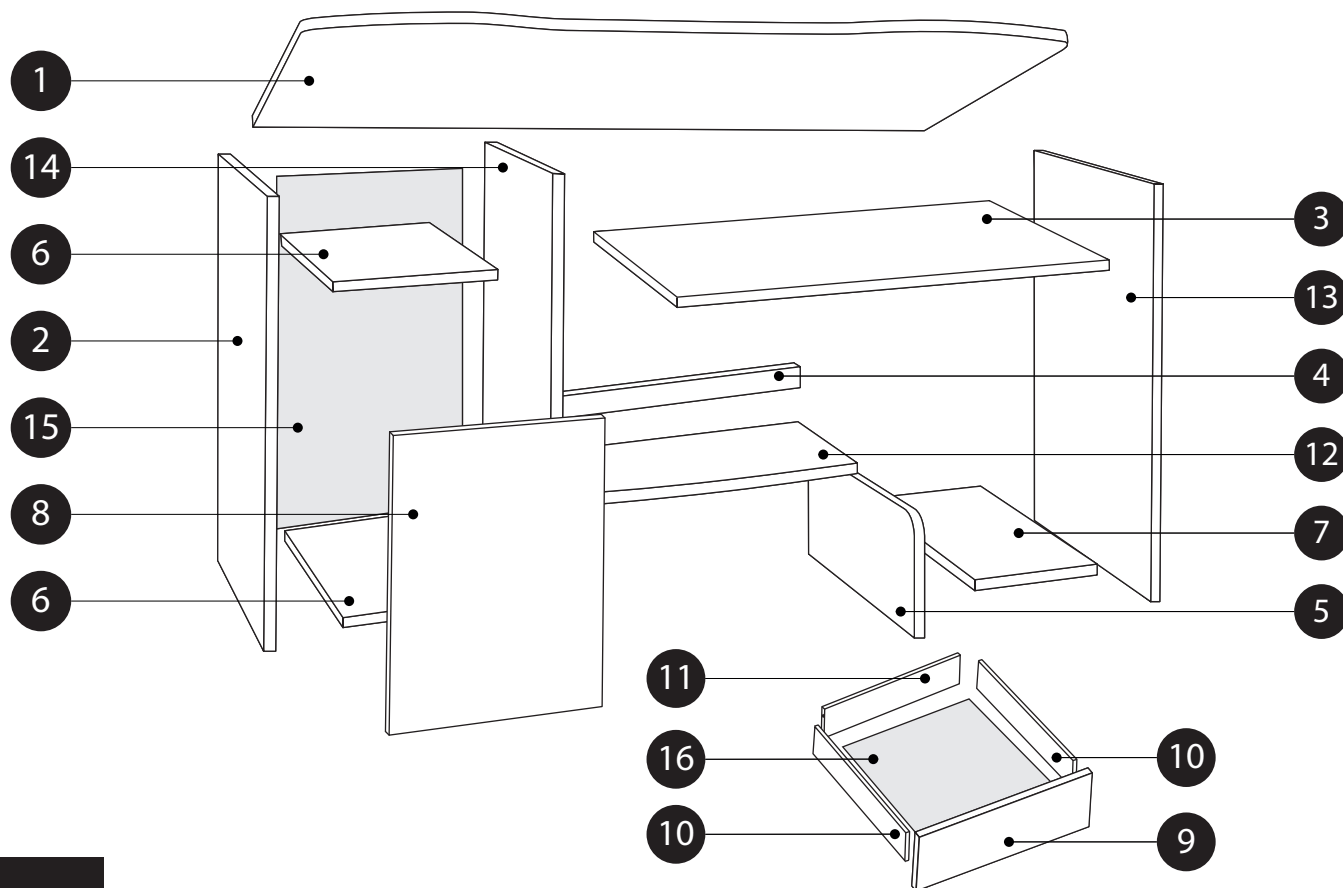
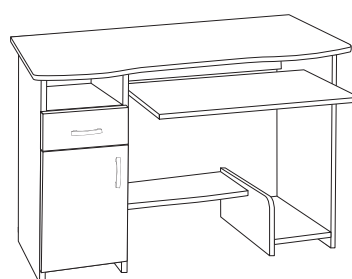

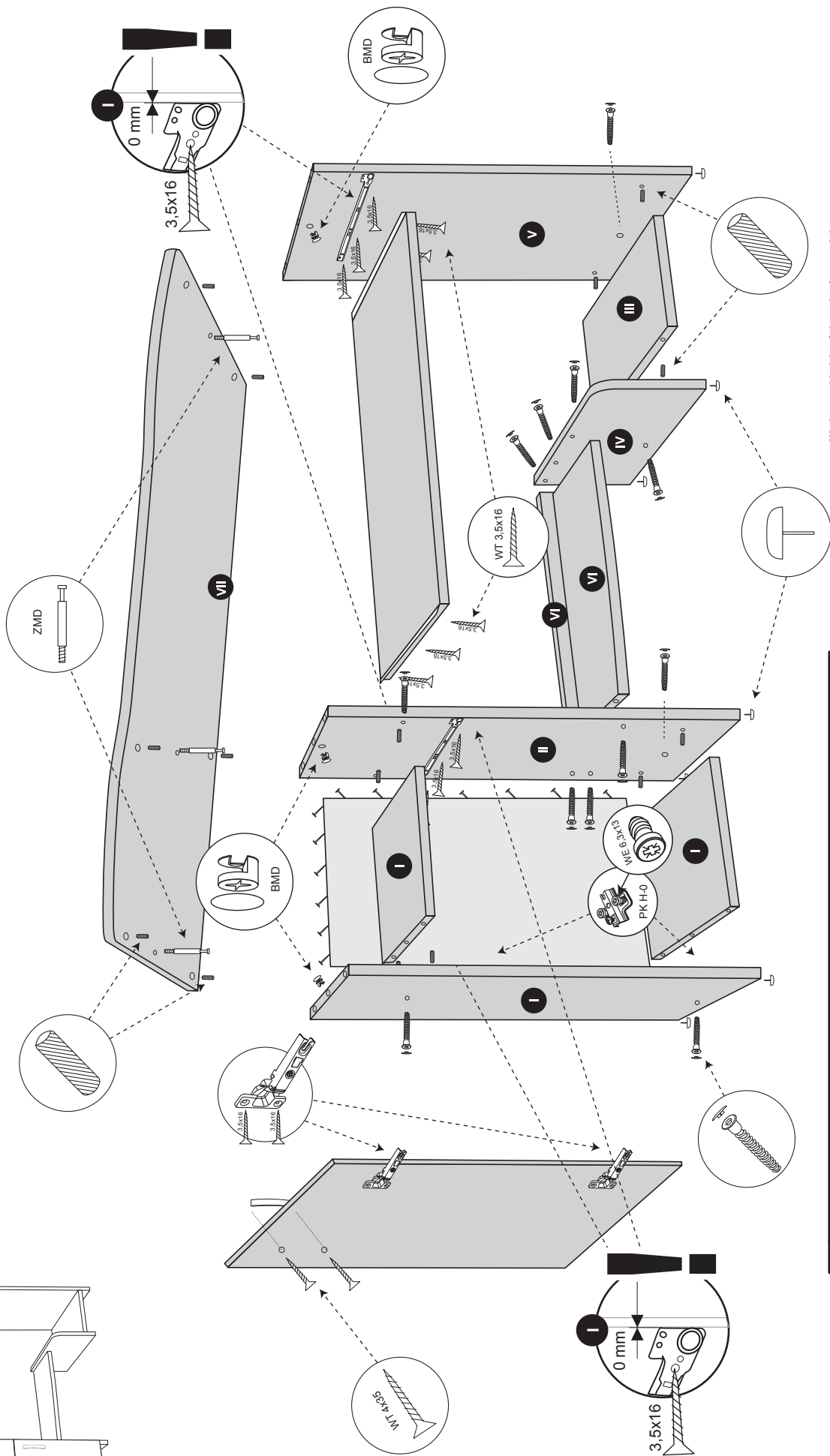
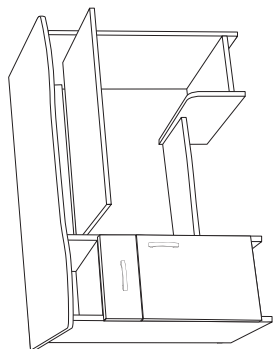

W pierwszej kolejności przykręć prowadnice.

I
 First, tighten the guides.
 Zuerst ziehen Sie die Führer.
 Za prvé, utiahnite prívody.
 Во-первых, укрепити гиды.
 Pirmausiaj prisukite bėgėlius.

!
UWAGA I - w pierwszej kolejności wbijamy akcesoria „KK” i „MD” w białe oraz boki.
WARNING I - The first accessory sticks „KK” and „MD” in the tops and sides.
WARNUNG I - Die erste Accessoire-Sticks „KK” und „MD” in den Spitzen und an den Seiten.
POZOR I - První příslušenství holi „KK” a „MD” v korunách a boky.
POZORI - Prvé príslušenstvo palic „KK” a „MD” v korunách a boky.
ВНИМАНИЕ I - Первый аксессуаров палочки „KK” и „MD” по верхинам и по бокам.
DĚMESIO I - Pirmausiaj furnitūrā KK ir MD įkalame į stalviršį ir šonus.

Kolejność montażu: I II III

