

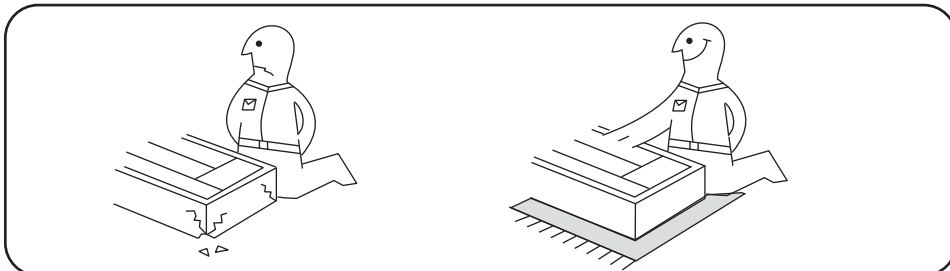

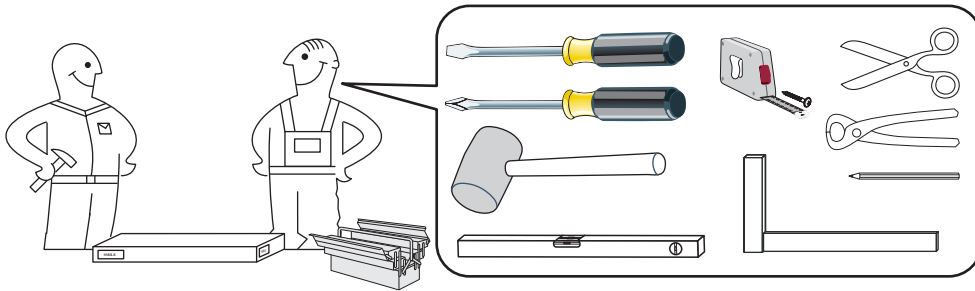

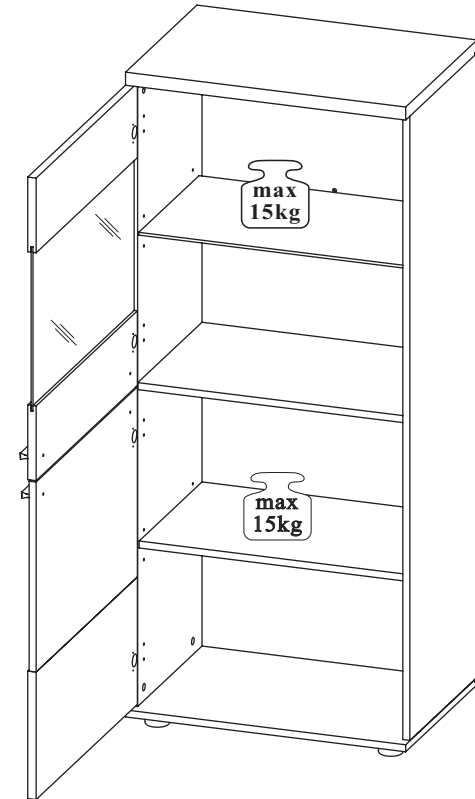

- (D) **Montageanleitung**
- (GB) **Assembly instructions**
- (NL) **Handleiding voor de montage**
- (PL) **Instrukcja montażu**
- (TR) **Montaj talimatı**
- (RU) **Инструкция по монтажу**

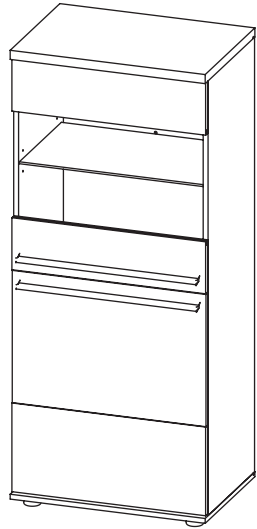



! Achtung • Attention • Opgelet • Uwaga • Dikkat Вниманіе !	
(D)	Bitte nur mit einem Staubtuch oder leicht feuchtem Lappen reinigen. Keine scheuernden Putzmittel verwenden.
(GB)	Please only clean with a duster or a damp cloth. Do not use any abrasive cleaners.
(NL)	Reinig alleen met een stofdoek of een lichtjes vochtige doek. Gebruik geen schurende poetsmiddelen.
(PL)	Czyszczenie należy wykonać wyłącznie za pomocą ściereczki lub lekko nawilżonego ręcznika. Nie stosować środków czyszczących do szorowania.
(TR)	Lüften sadece bir toz beziyile veya hafif nemli yumuşak bir bezle siliniz. Aşındırıcı temizlik malzemeleri kullanmayınız.
(RU)	Очищайте от пыли тряпкой или слегка влажной ветошью. Не допускается применение чистящих средств, не предназначенных для ухода за мебелью.

B1  ϕ 8x28 x12

M1  x12

T1  x12

C2  x12

W2  x8

P3  3x18 x4

F1  x4

J23  x8

C3  ϕ 8 x1

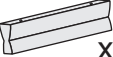
U48  x2

P5  4x30 x6

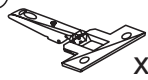
Y0  x4
Kr0

Y5  x4
H2

S8  4x13 mm x8

E1  6,3x13 x8

F10  x4

P4  4x25 x4

J44  x1

P13  3,5x13 x1

G22  ϕ 18 x2

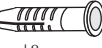
T13  ϕ 8 x1

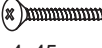
S15  4x45 x1

L10  x2

1

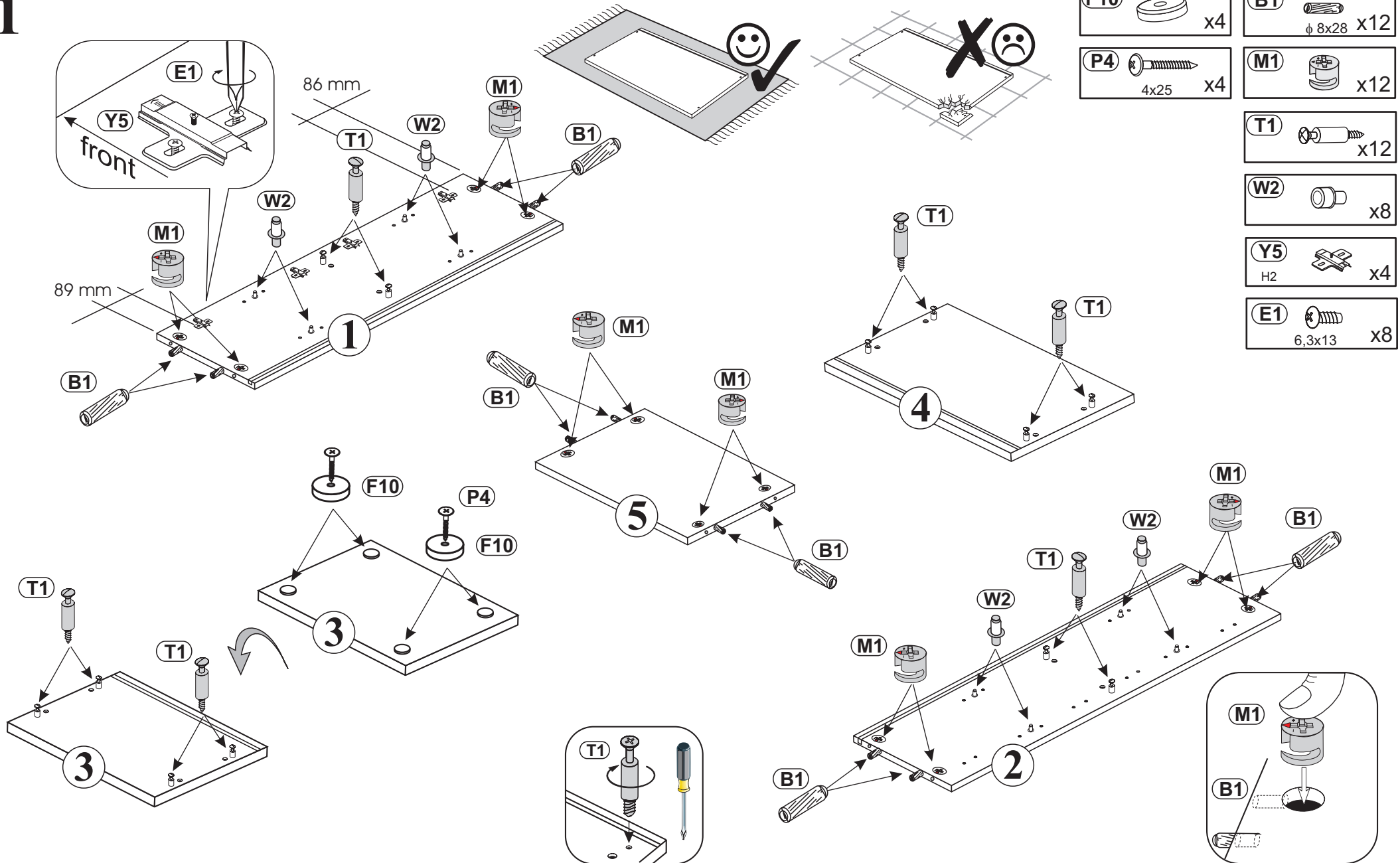
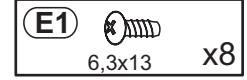
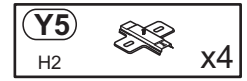
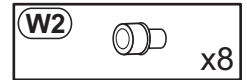
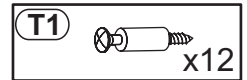
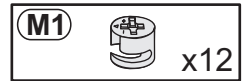
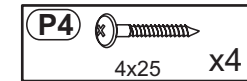
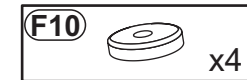

2

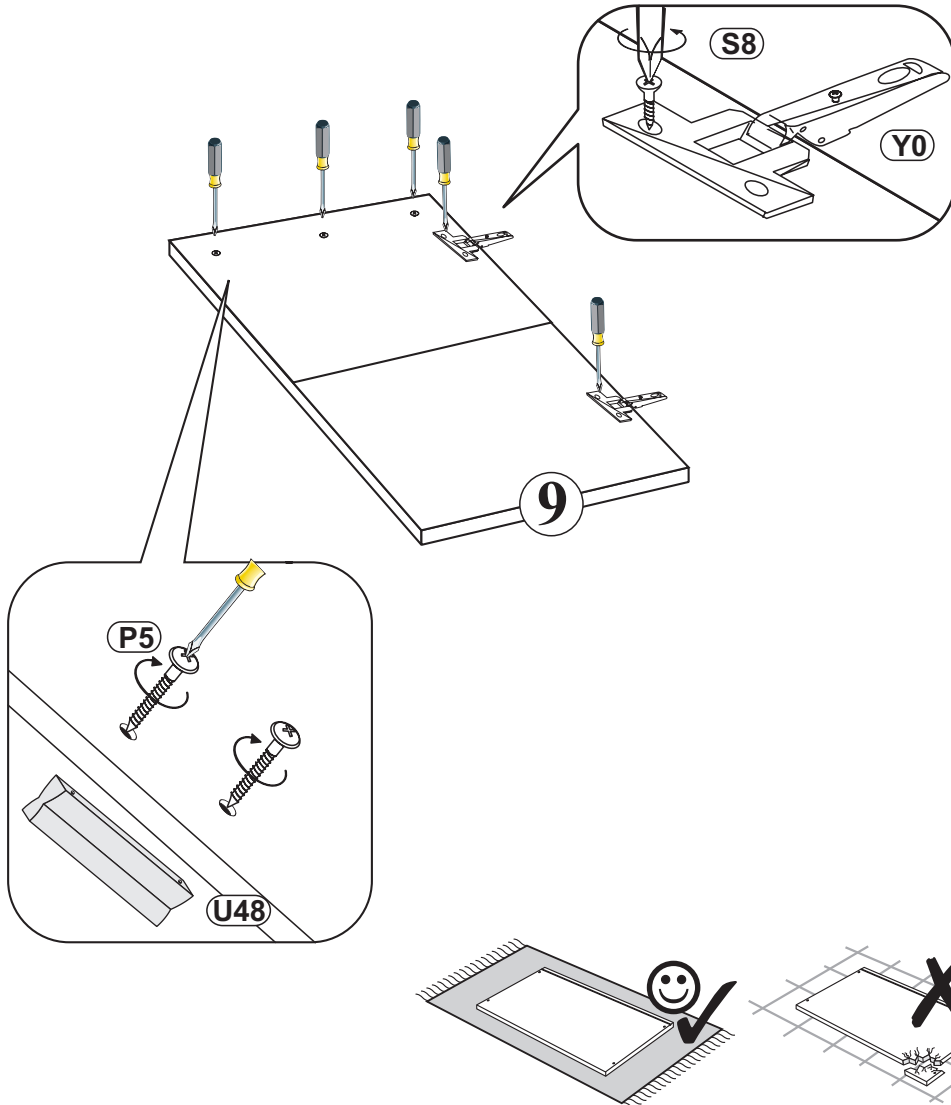
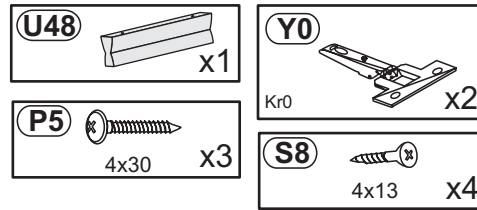

3

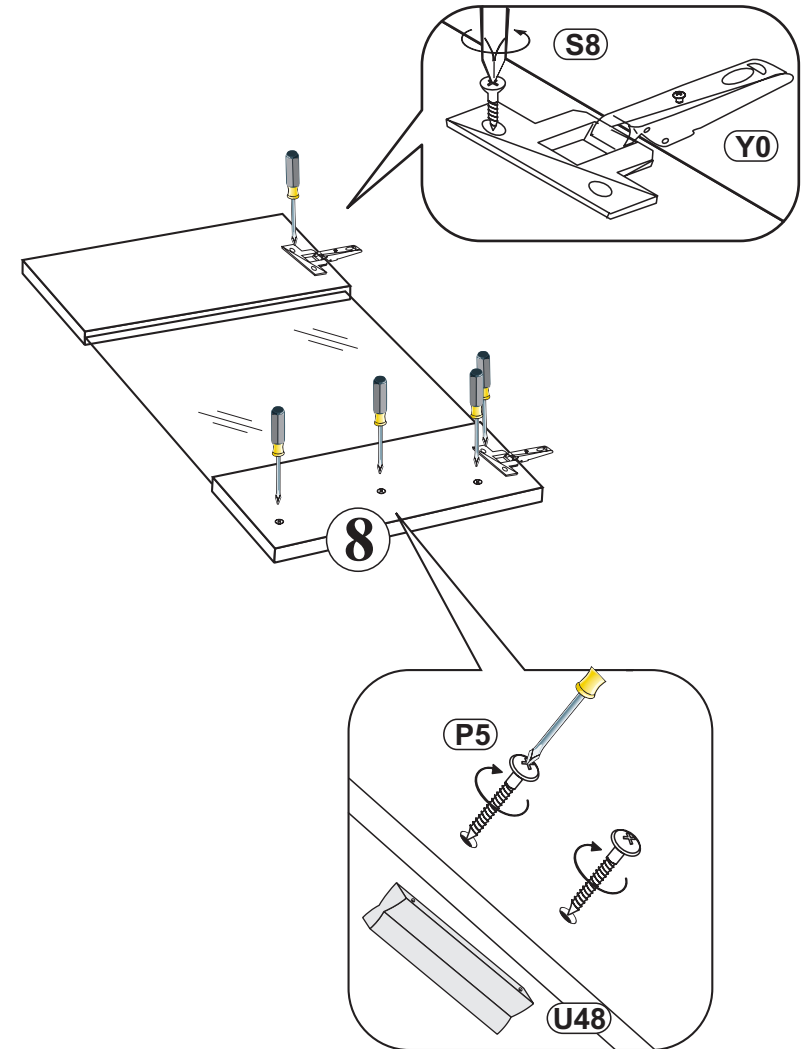
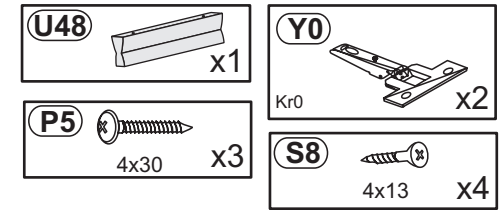

4

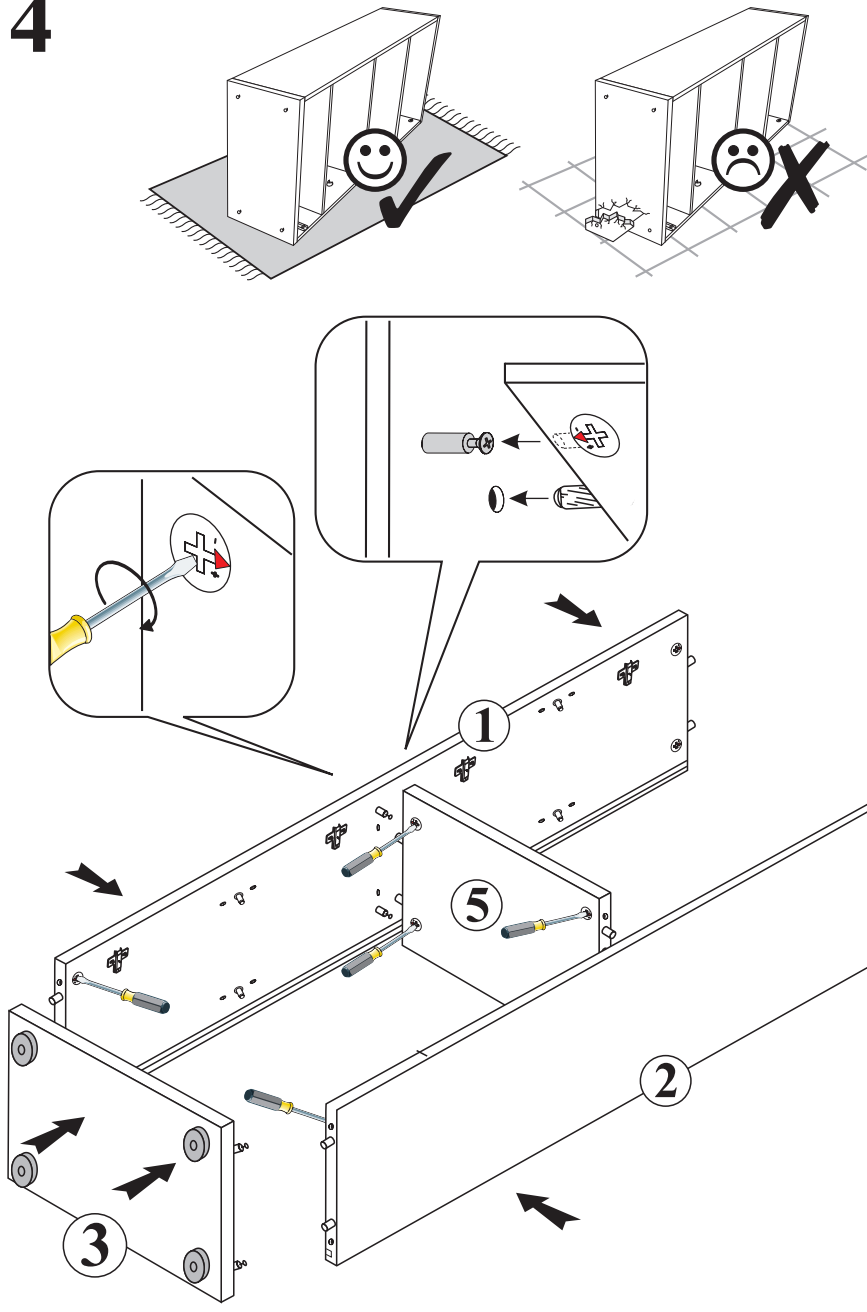

5

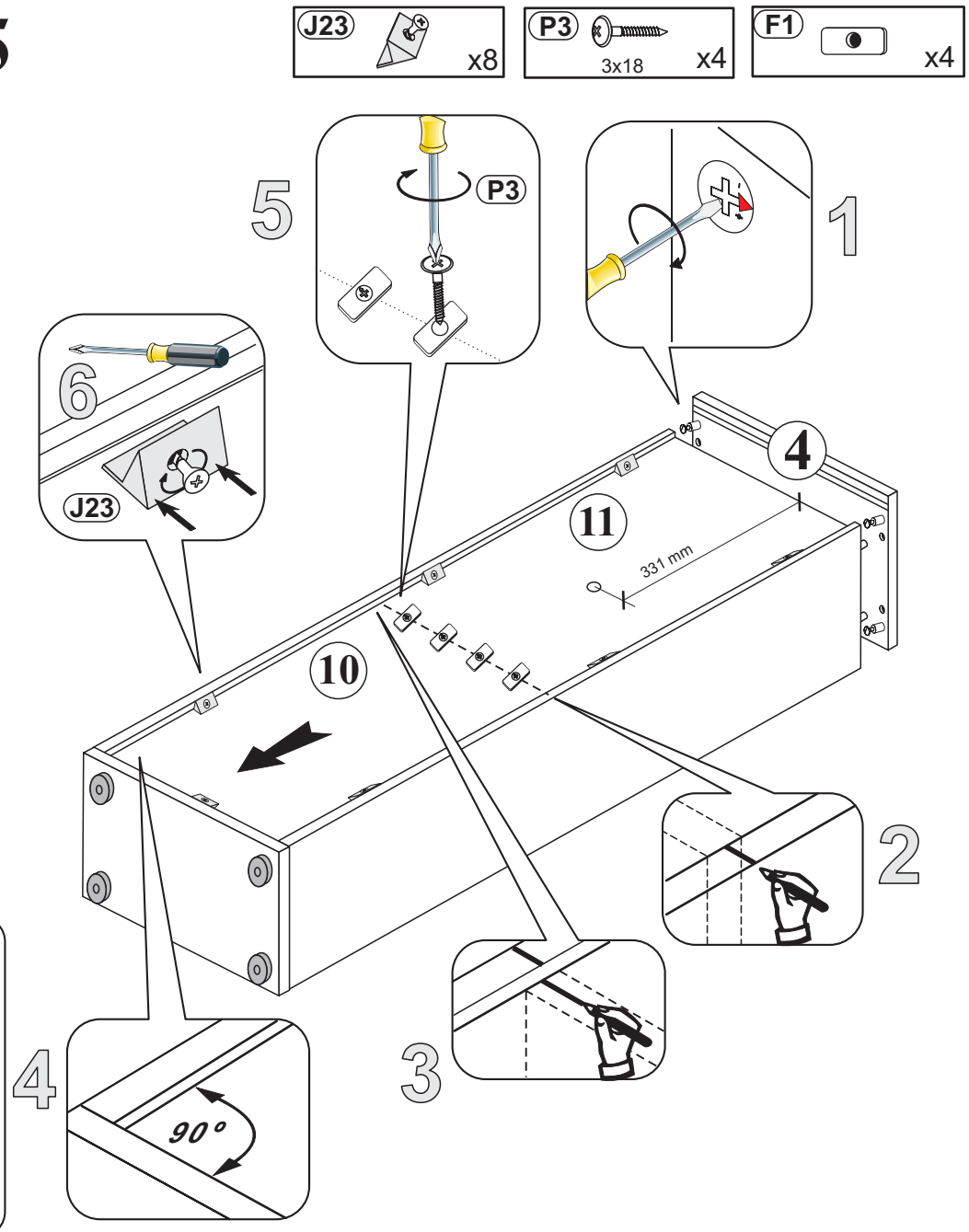

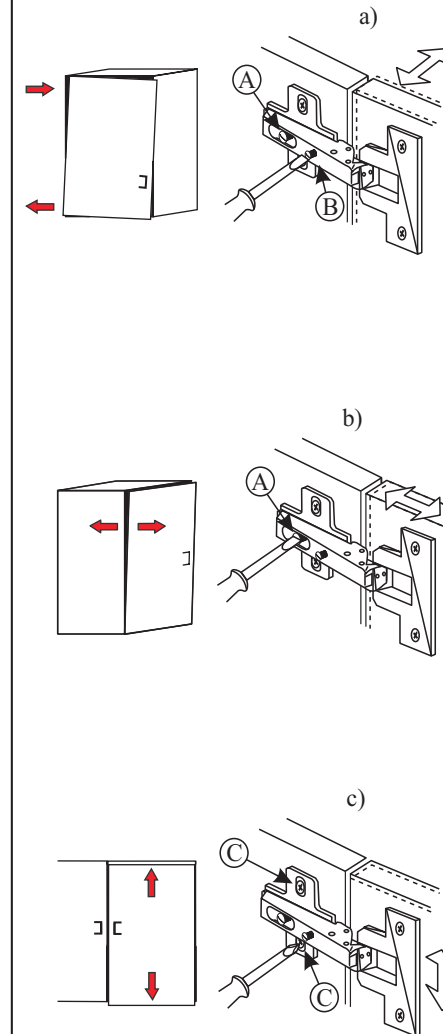
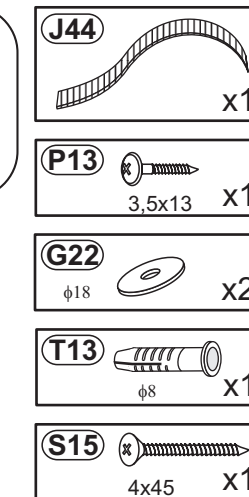
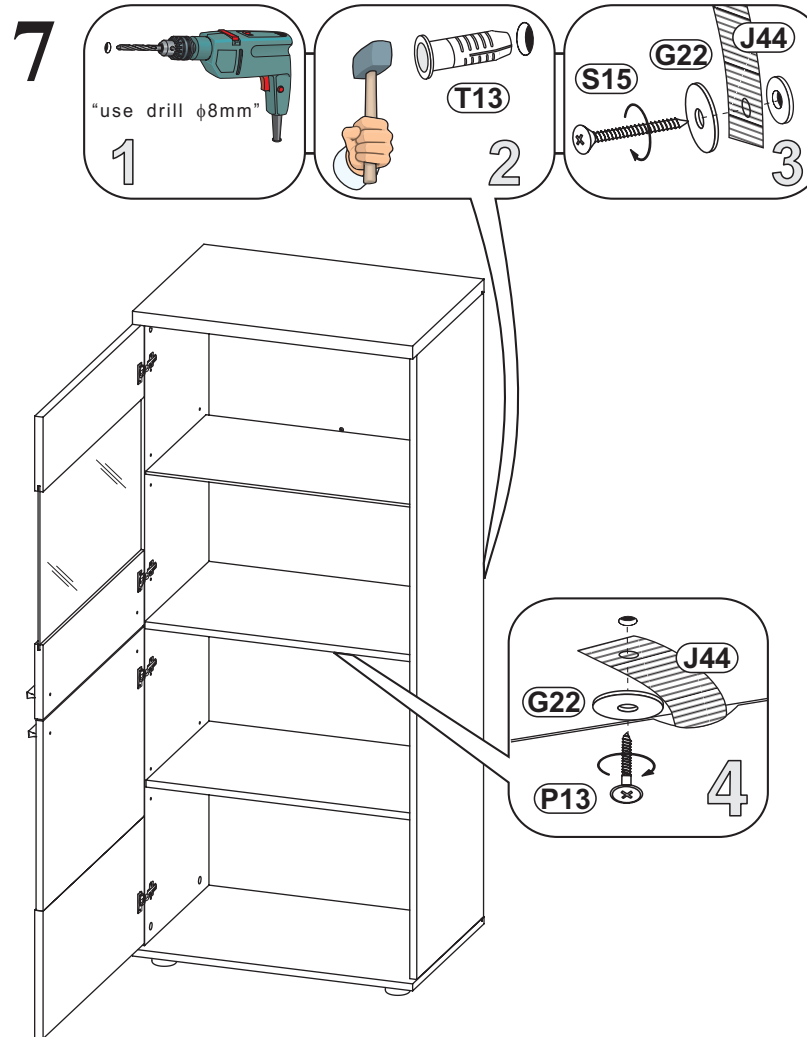
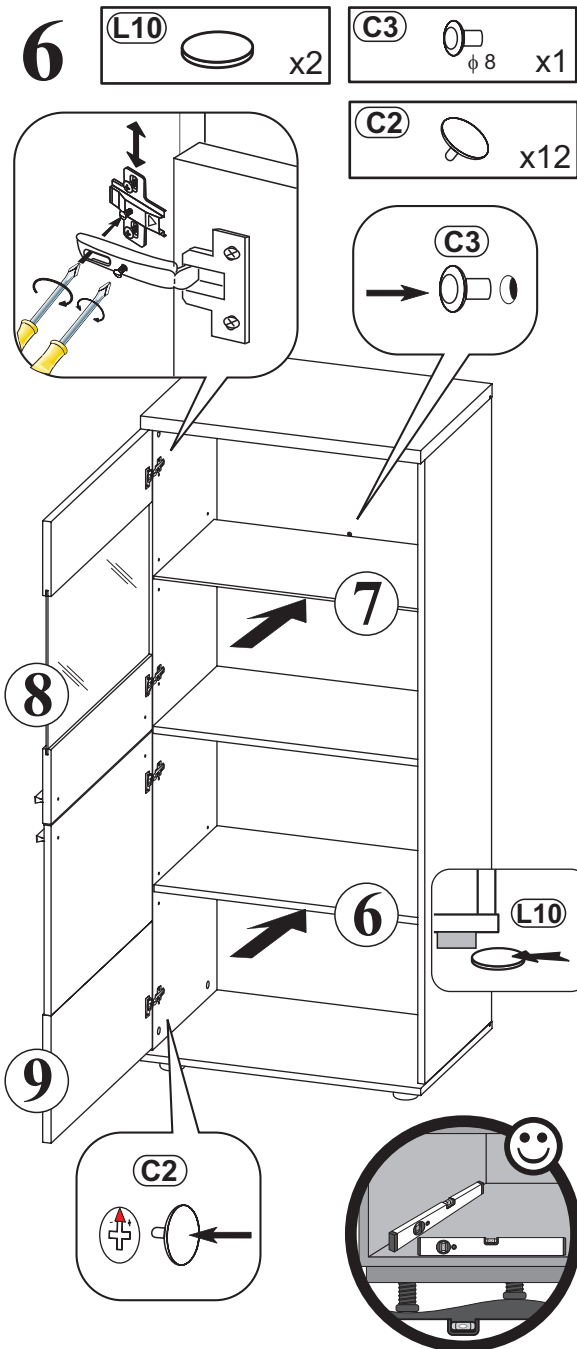

Achtung • Attention • Opgelet • Uwaga • Dikkat • Внимание	
D	Wandbefestigung dient als
GB	The wall fastening serves to prevent tipping – be absolutely
NL	Bevestiging aan de muur dient als kantelbescherming –
PL	Mocowanie do ściany jest jednocześnie zabezpieczeniem przed przewróceniem – koniecznie zamontować! Do niektórych rodzajów ścian konieczne mogą być specjalne wkręty!
TR	Duvardaki sabitleme, devrilmeye karşı bir emniyet tedbiridir ve mutlaka monte edilmelidir! Bazı duvar tiplerinde bunun için özel bir dübel gerekli olabilir!
RU	Обязательно установите крепление на стене во избежание опрокидывания! Для некоторых типов стен может потребоваться специальный дюбель!

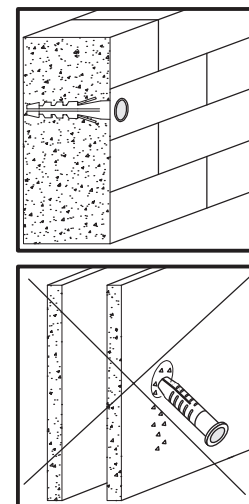

Service • Dienstverlening • Serwis • Servis • Сервисная служба

Name • Naam • Nazwa • İsim • Название
BRIGHT
Nr. • No. • Номер
37 -- BR
Typ • Type • Тип • Тип
01

