

LAREDO

L-5

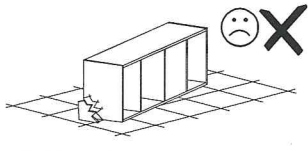

Narzędzia potrzebne do montażu

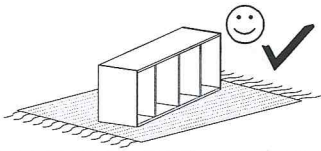
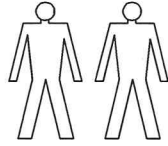
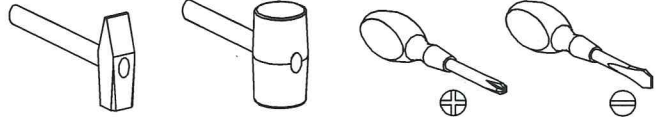

UWAGA !
MONTOWANIE USZKODZONYCH
ELEMENTÓW POWODUJE UTRATĘ
GWARANCJI

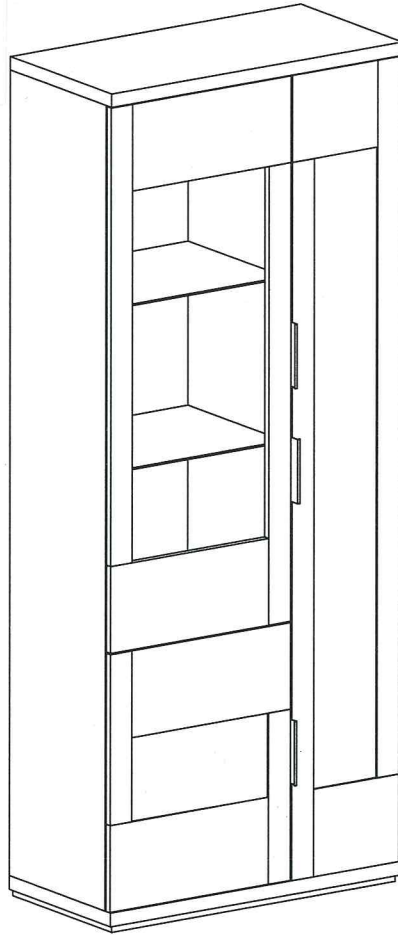

W przypadku reklamacji proszę o podanie numeru pakowacza znajdującego się na kartonie

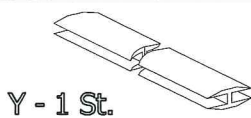

Y - 1 St.

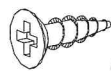

G - 14 St.
3,5 x 16 mm



U - 3 St.

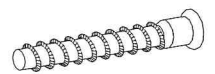

W - 2 St.



S - 8 St.

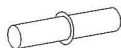

P - 16 St.

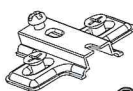

C - 7 St.

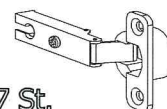

D - 7 St.



H - 6 St.
3,5 x 13 mm



E - 60 St.



B - 18 St.

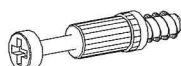

K - 18 St.

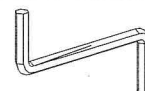

Z - 1 St.

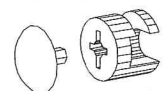

L - 18 St.

I

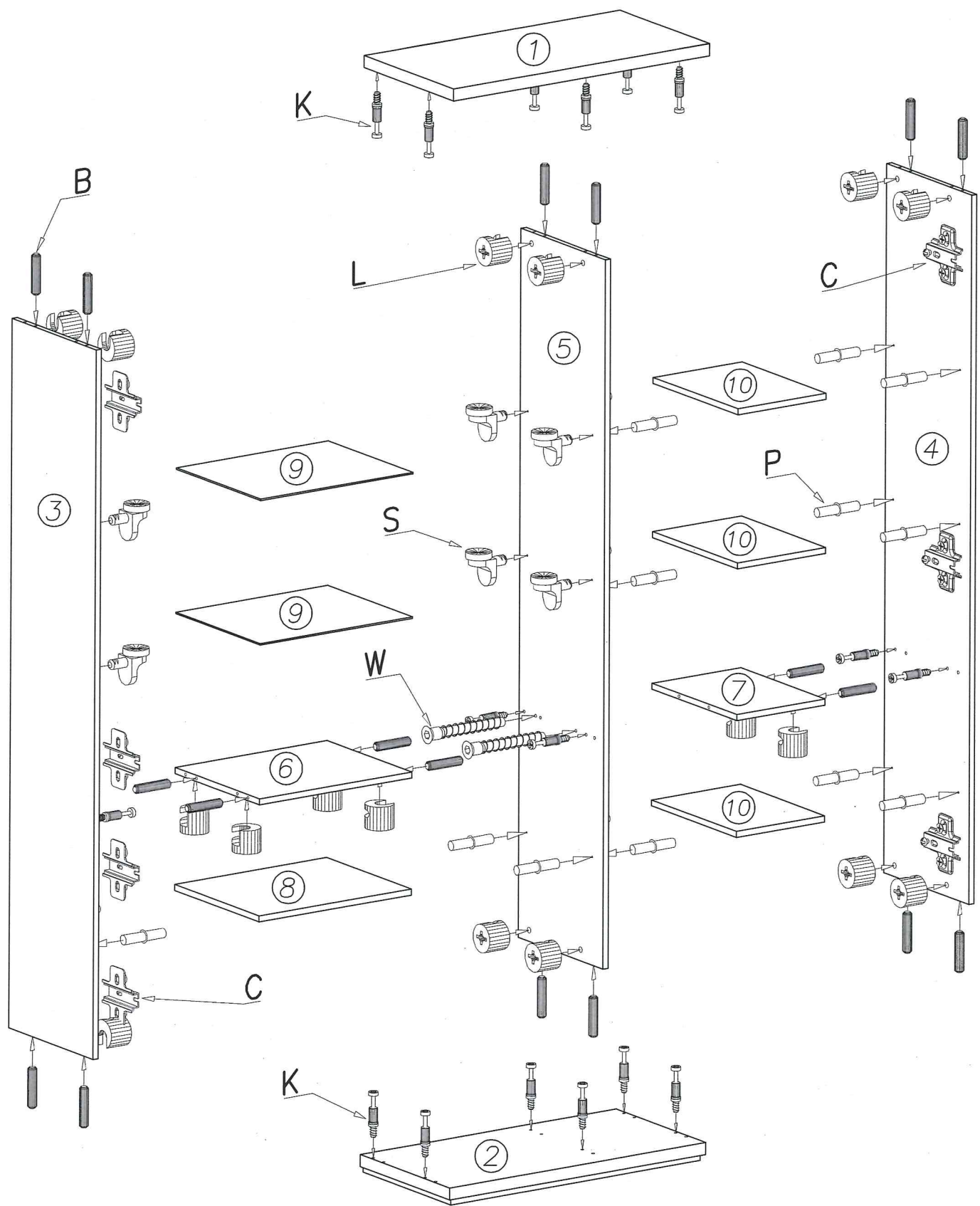

II

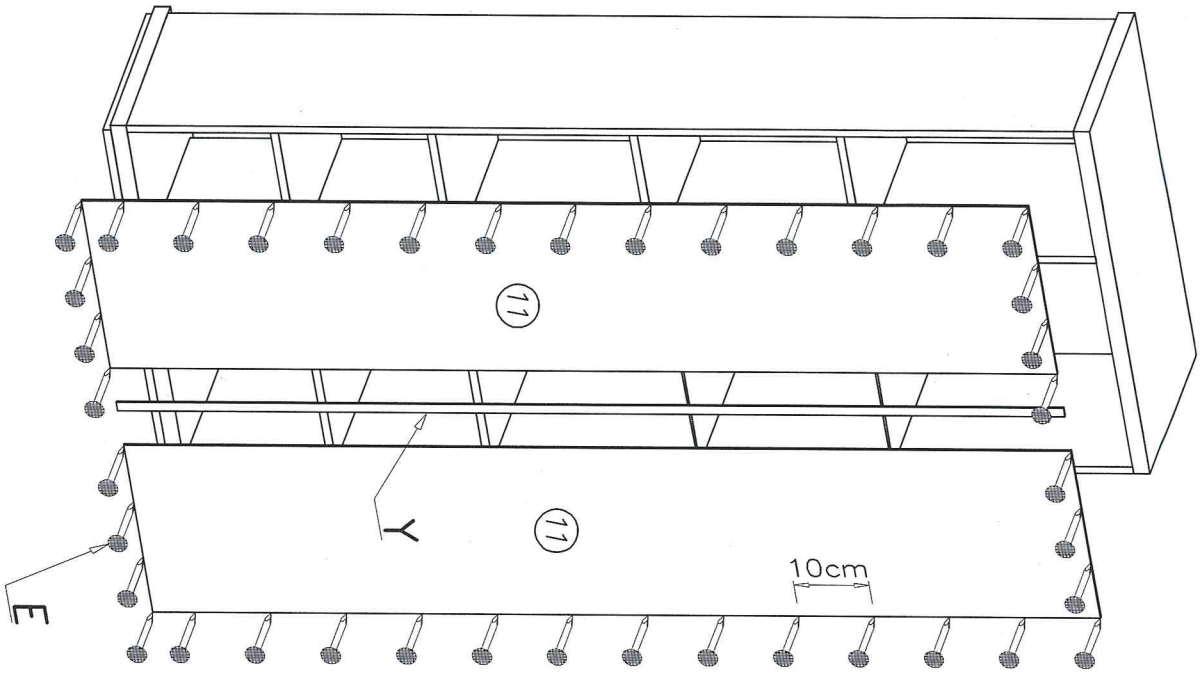

III

