

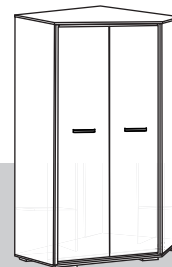

www.MLMEBLE.pl

GB assembly instructions / D montageanleitung / CZ montážní návod / SK montážny návod / RUS инструкции по монтажу / LT surinkimo instrukcija



# INSTRUKCJA MONTAŻU

**BONTI 01**  
**↑ 190 → 92 ↘ 92**

akcesoria / accessories / zubehör / příslušenství / prislušenstvo / аксесуары / furnitūra :



x 18  KK 8/32	x 18  KT 6,3/50	x 100  GZ 1,4/25	x 11  MD	x 9  ZAM	x 4  UB 0	x 24  PA Ø5	x 32  WT 3,5x16	x 4  WT 4x27	x 21  WT 4x30	x 12  WT 4x35
x 6  ZA 45°	x 6  PK H-2	x 12  WE 6,3x13	x 24  BDP	x 2  drażek / stick / stock / hůl / palica / трость / styvas	x 1  LT	x 2  UTO	x 7  ST BI-150	x 1  klej / glue / kleber / lepidlo / lepido / kney / kljaj	x 1  kluczyk / key / schlüssel / klíč / kľúč / kľuč / raktas	

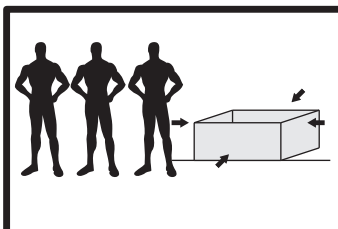
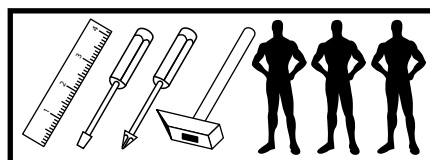

**do montażu potrzebne są:**  
 are needed for assembly:  
 sind erforderlich für die montage:  
 jsou potřebné pro montáž:  
 sú potrebné pre montáž:  
 которые необходимы для сборки:  
 Surinkimui reikės:



**UWAGA !** - mebel należy składać w pozycji poziomej  
**WARNING!** - furniture should be submitted in a horizontal position  
**WARNUNG!** - Möbel sollten in einer horizontalen Position vorzulegen  
**POZOR!** - Nábytek by měl být předložen ve vodorovné poloze  
**POZOR!** - Nábytok by mal byť predložený vo vodorovnej polohe  
**ВНИМАНИЕ!** - Мебель должна быть представлена в горизонтальном положении  
**DĚMESIO!** - Baldą surenkame horizontalioje padėtyje

**UWAGA !** - w pierwszej kolejności wbijamy akcesoria „KK” i „MD” w blaty oraz boki.  
**WARNING!** - The first accessory sticks "KK" and "MD" in the tops and sides.  
**WARNUNG!** - Die erste Accessoire-Sticks "KK" und "MD" in den Spitzen und an den Seiten.  
**POZOR!** - První příslušenství holí "KK" a "MD" v korunách a boky.  
**POZOR!** - Prvé príslušenstvo palíc "KK" a "MD" v korunách a boky.  
**ВНИМАНИЕ!** - Первый аксессуаров палочки "KK" и "MD" по верхинам и по бокам.  
**DĚMESIO!** - Pirmiausiai furnitūrą KK ir MD įkalame į stalviršį ir šonus.

	CODE			
1	BONTI01_01	1838	402	1
2	BONTI01_02	1838	402	1
3	BONTI01_03	915	915	1
4	BONTI01_04	915	914	1
5	BONTI01_05	342	1792	2
6	BONTI01_06	331	245	3
7	BONTI01_07	1838	287	1
8	BONTI01_08	1838	287	1
9	BONTI01_09	1838	250	1
10	BONTI01_10	595	100	1
11	BONTI01_11	270	269	1
12	BONTI01_12	270	269	3
13	BONTI01_13	331	245	1
14	BONTI01HDF_01	1865	353	1
15	BONTI01HDF_02	1865	292	2

	CODE			
16	BONTI01HDF_03	1865	307	2
17	BONTI01W_01	1837,5	80	1
18	BONTI01W_02	795	80	1
19	BONTI01W_03	1837,5	80	1
20	BONTI01W_04	795	80	1

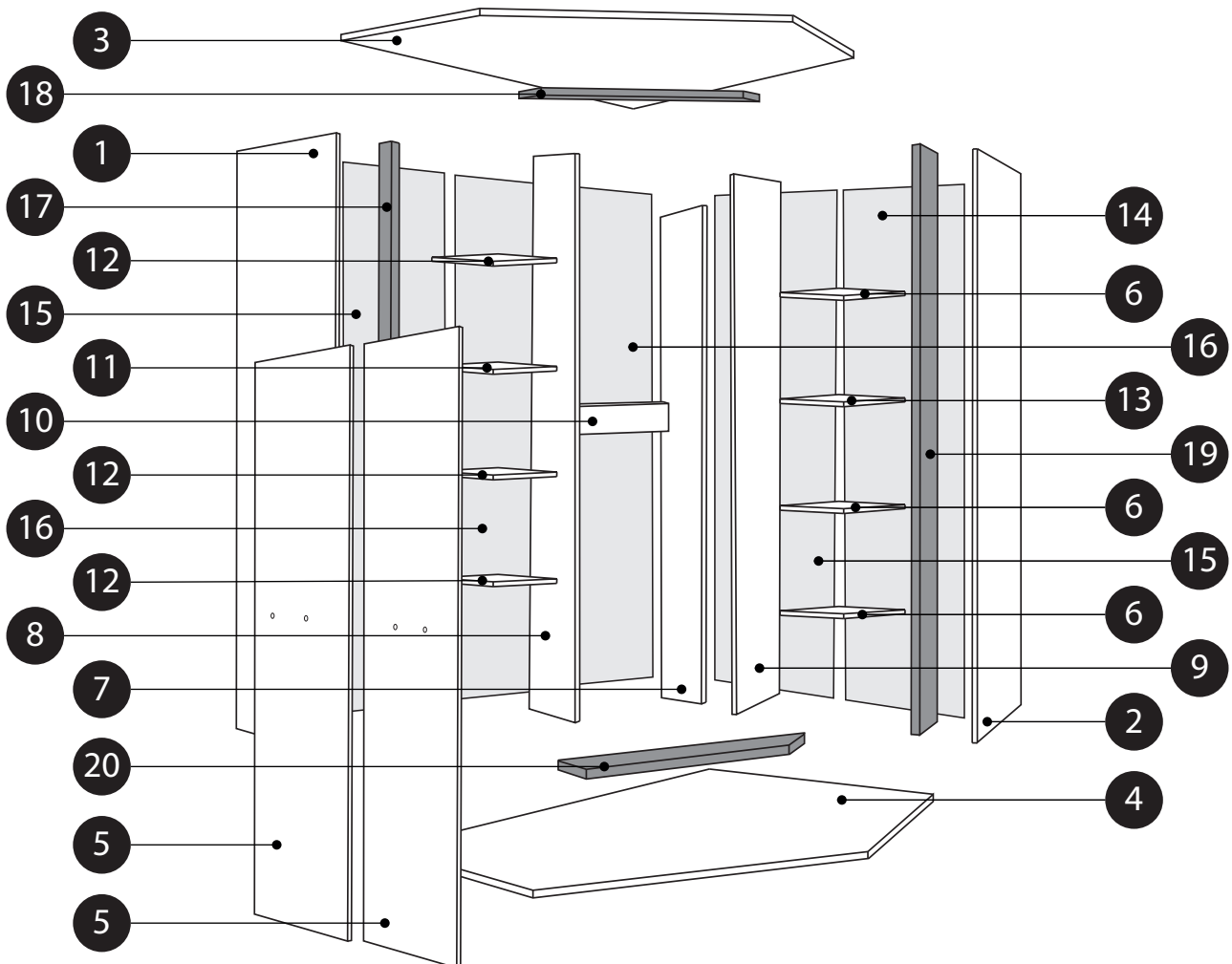
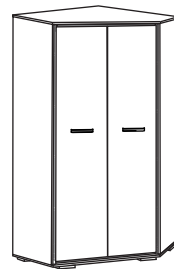

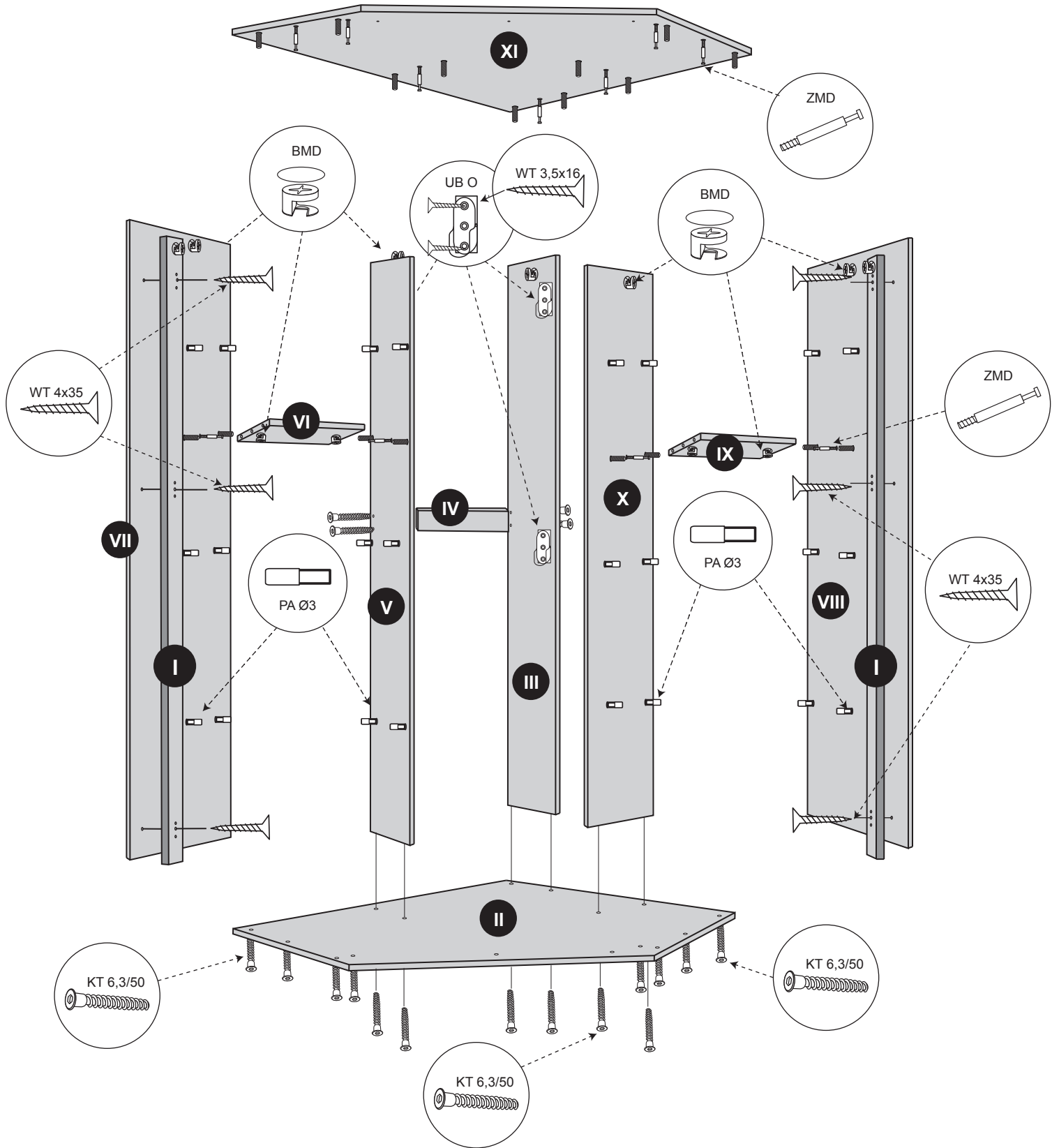

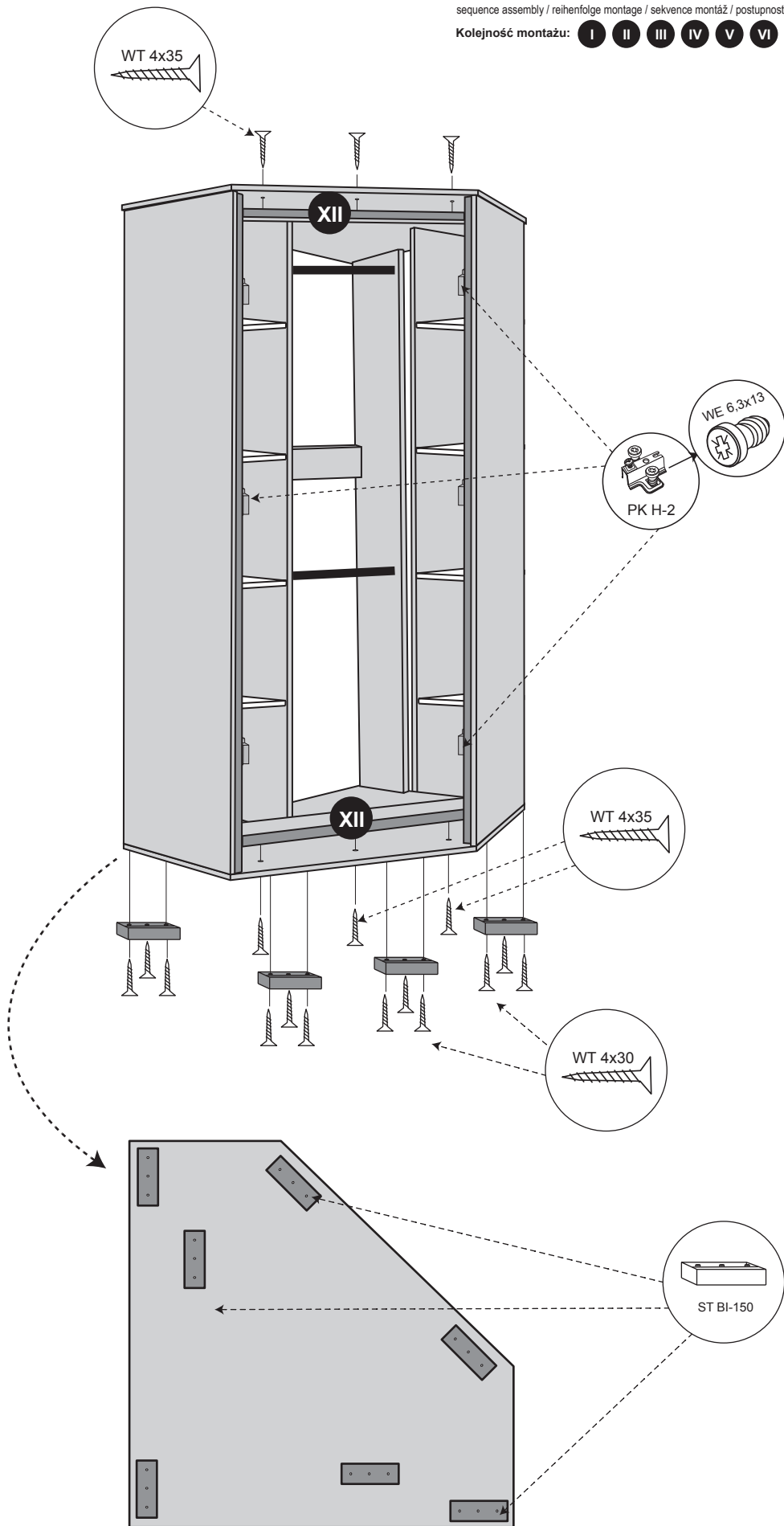

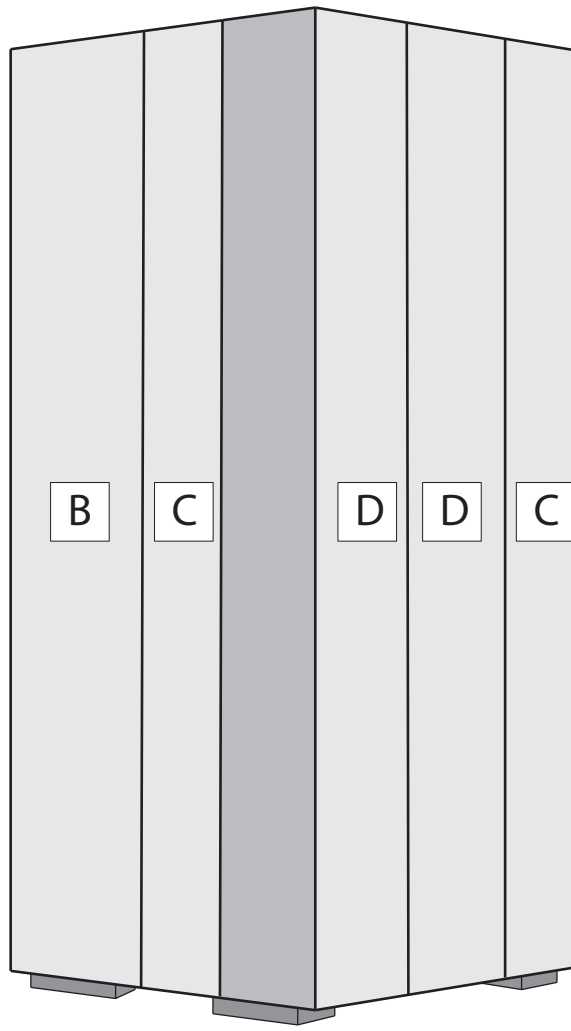

- B** 1865x353
- C** 1865x292
- D** 1865x307

