

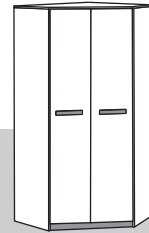

www.MLMEBLE.pl



GB assembly instructions / D montageanleitung / CZ montážní návod / SK montážny návod / RU инструкции по монтажу / LT surinkimo instrukcija



# INSTRUKCJA MONTAŻU

**BEST 01**

199 92 92

akcesoria / accessories / zubehör / příslušenství / prislušenstvo / аксесуары / furnitūra :

x 22  KK 8/32	x 17  KT 6,3/50	x 8  ZA N	x 100  GZ 1,4/25	x 8  SG 8/8	x 17  MD	x 11  ZAM	x 4  UB 0	x 24  PA Ø5	x 30  WT 3,5x16	x 4  WT 4x30
x 6  ZA 45°	x 6  PK H-4	x 12  WE 6,3x30	x 2  PO Ø5 E	x 24  BDP	x 6  DPP 03	x 2  drażek / stick / stock / hůl / palica / трость / strypas	x 1  LT	x 2  UT 1.839	x 1  klej / glue / kleber / lepidlo / lepidlo / клей / kljaj	x 1  kluczyk / key / schlüssel / klíč / ключ / raktas

do montażu potrzebne są:

are needed for assembly:  
sind erforderlich für die montage:  
jsou potřebné pro montáž:  
sú potrebné pre montáž:  
сú потрібні для зборки:  
Surinkimui reikės:

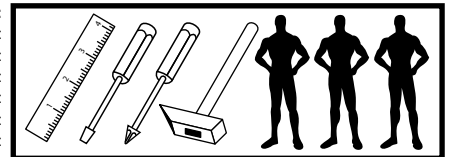

**UWAGA !** - W pierwszej kolejności wbijamy akcesoria „KK” i „MD” w blaty oraz boki i montujemy prowadnice.

**WARNING!** - In the first place should be driven accessories "KK" and "MD" in the tops and sides and guides.

**WARNUNG!** - In erster Linie sollte Accessoires "KK" und "MD" in den Wipfeln und an den Seiten und Guides gefahren werden.

**POZOR!** - V první řadě by měl být tažen příslušenství "KK" a "MD" v korunách a po stranách a průvodců.

**POZOR!** - V prvom rade by mal byť ťahaný príslušenstvo "KK" a "MD" v korunách a po stranách a sprievodcov.

**ВНИМАНИЕ!** - В первую очередь следует руководствоваться аксесуары "KK" и "MD", на вершинах и по бокам и руководства.

**DĚMESIO!** - Pirmiausiai furnitūrą KK ir MD įkalame į stalviršį ir šonus ir prisukame bėgelius.

**UWAGA !** - w pierwszej kolejności wbijamy akcesoria „KK” i „MD” w blaty oraz boki.

**WARNING!** - The first accessory sticks "KK" and "MD" in the tops and sides.

**WARNUNG!** - Die erste Accessoire-Sticks "KK" und "MD" in den Spitzen und an den Seiten.

**POZOR!** - První příslušenství holí "KK" a "MD" v korunách a boky.

**POZOR!** - Prvé príslušenstvo palic "KK" a "MD" v korunách a boky.

**ВНИМАНИЕ!** - Первый аксесуаров палочки "KK" и "MD" по вершинам и по бокам.

**DĚMESIO!** - Pirmiausiai furnitūrą KK ir MD įkalame į stalviršį ir šonus.

Nr/No	Szt/Qty
1	1
2	2
3	1
4	2
5	1
6	1
7	1
8	1
9	1
10	1
11	3
12	1
13	3
14	1
15	2
16	2
17	2
18	1

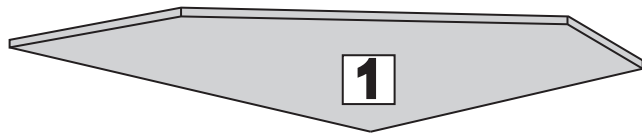

**2**

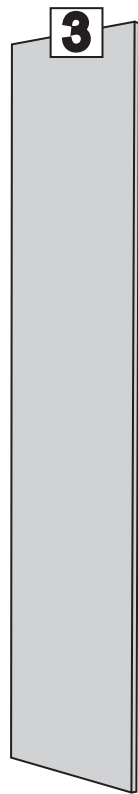

**4**

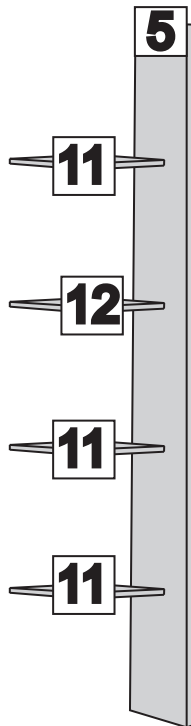

**5**

**11**

**12**

**11**

**11**

**10**

**6**

**7**

**13**

**14**

**13**

**13**

**4**



**8**

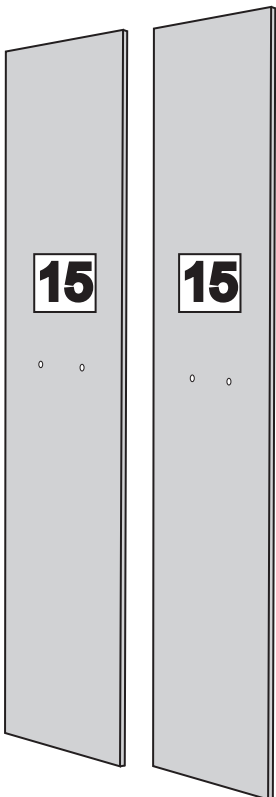

**15**

**15**

**2**

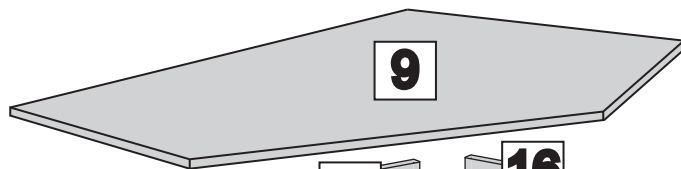

**9**



**16**



**16**



**17**



**17**



**18**

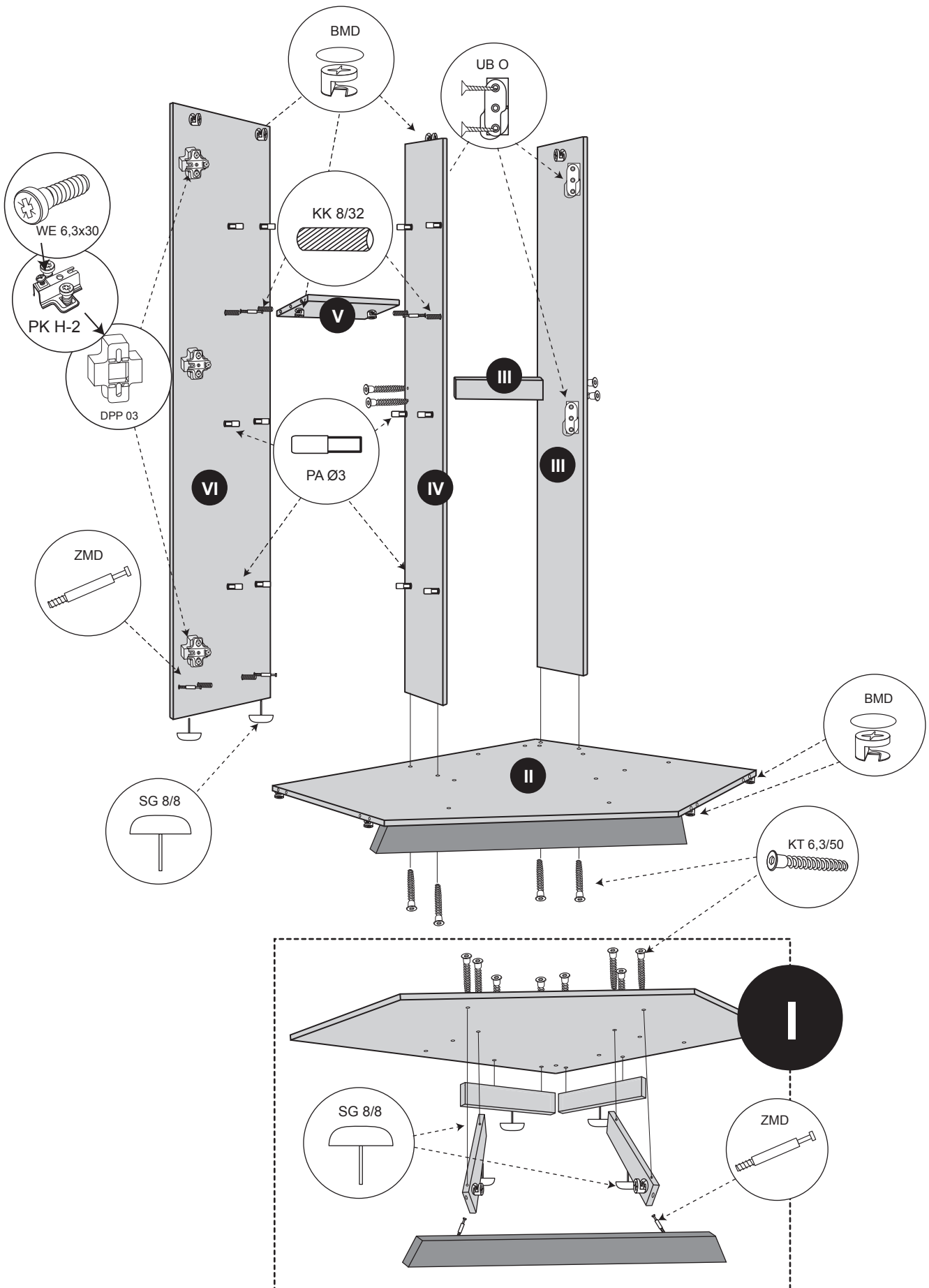

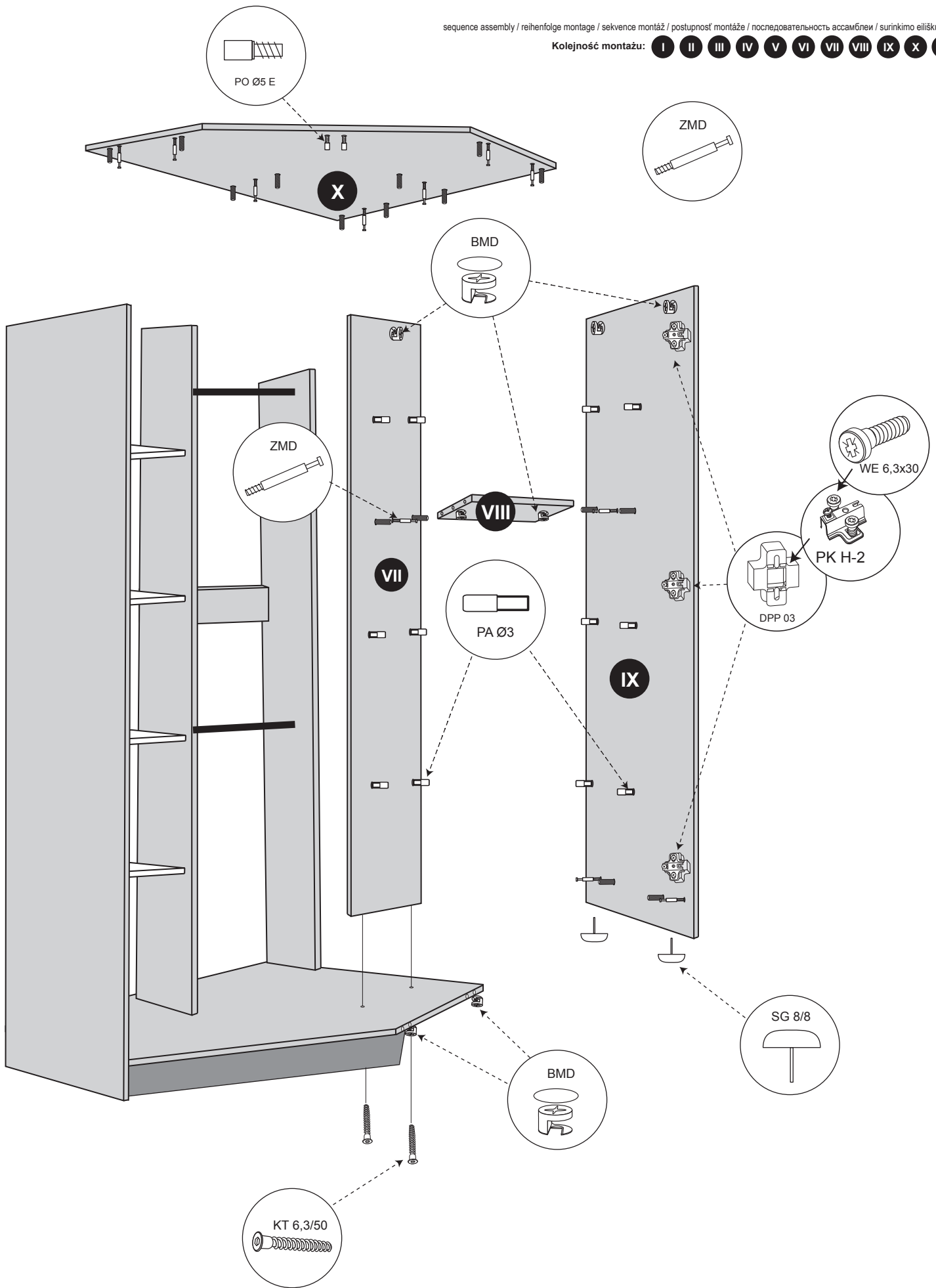

**XI**

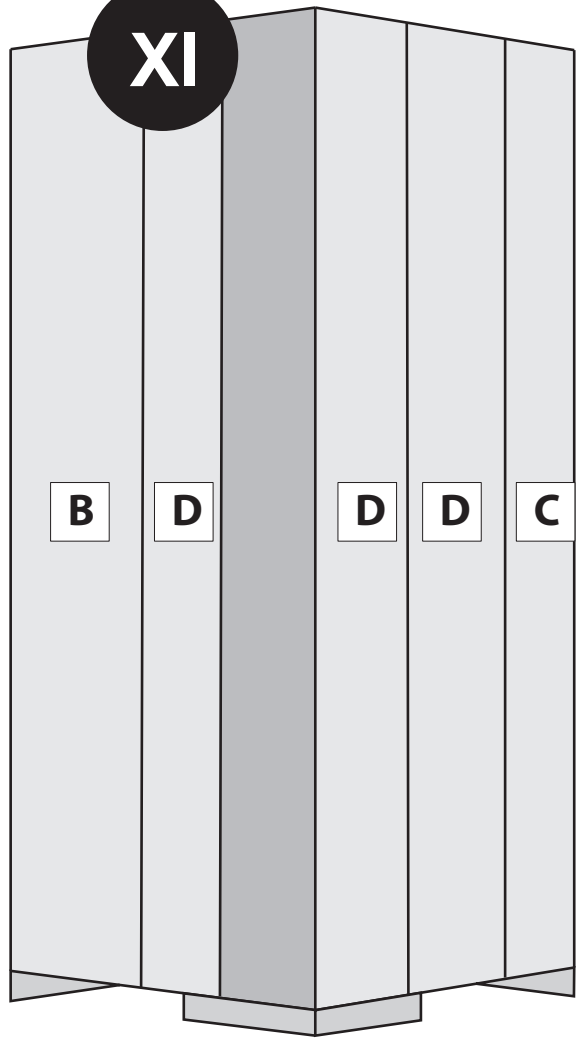

- B** 1908 x 337
- C** 1908 x 273
- D** 1908 x 307

