

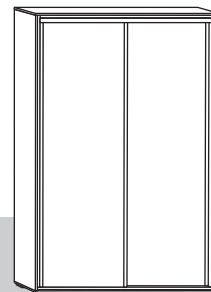

www.MLMEBLE.pl



GB D CZ SK RUS LT
assembly instructions / montageanleitung / montážní návod / montážny návod / инструкции по монтажу / surinkimo instrukcija



INSTRUKCJA MONTAŻU

BONTI 02

↑190 →110 ↗67

akcesoria / accessories / zubehör / příslušenství / prislušenstvo / аксесуары / furnitūra :

x 26 KK 8/32	x 9 KT 6,3/50	x 2 KT 6,4/70	x 8 ZA N	x 100 GZ 1,4/25	x 16 MD	x 4 UB 0	x 12 PA Ø5	x 8 WT 3,5x16	x 9 WTLP 3x16	x 18 WT 4x30	
x 15 WT 4x35	x 18 BDP	x 2 drażek / stick / stock / hůl / palica / трость / strypas	x 1 TG	x 1 TD	x 1 ZAT	x 4 WZD	x 4 WZG	x 8 WT 4x23	x 2 SZT L-1970	x 2 SR HI-TEC	
x 5 ST BI-150	x 1 klej / glue / kleber / lepidlo / lepido / клей / klijai	x 1 kluczyk / key / schlüssel / klíč / ključ / ключ / raktas									

do montażu potrzebne są:
are needed for assembly:
sind erforderlich für die montage:
jsou potřebné pro montáž:
sú potrebné pre montáž:
которые необходимы для сборки:
Surinkimui reikės:

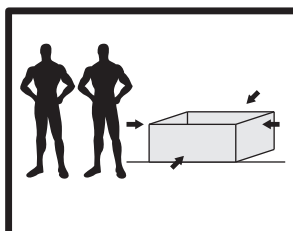
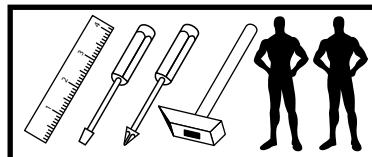

UWAGA ! - mebel należy składać w pozycji poziomej
WARNING! - furniture should be submitted in a horizontal position
WARNUNG! - Möbel sollten in einer horizontalen Position vorzulegen
POZOR! - Nábytek by měl být předložen ve vodorovné poloze
POZOR! - Nábytok by mal byť predložený vo vodorovnej polohe
ВНИМАНИЕ! - Мебель должна быть представлена в горизонтальном положении
DĚMESIO! - Baldą surenkame horizontalioje padėtyje

UWAGA ! - w pierwszej kolejności wbijamy akcesoria „KK” i „MD” w blaty oraz boki.
WARNING! - The first accessory sticks "KK" and "MD" in the tops and sides.
WARNUNG! - Die erste Accessoire-Sticks "KK" und "MD" in den Spitzen und an den Seiten.
POZOR! - První příslušenství holí "KK" a "MD" v korunách a boky.
POZOR! - Prvé príslušenstvo palíc "KK" a "MD" v korunách a boky.
ВНИМАНИЕ! - Первый аксессуаров палочки "KK" и "MD" по вершинам и по бокам.
DĚMESIO! - Pirmiausiai furnitūrą KK ir MD įkalame į stalviršį ir šonus.

Nr/No	Szt/Qty
1	1
2	1
3	1
4	2
5	1
6	1
7	1
8	3
9	1
10	1
11	1
12	2

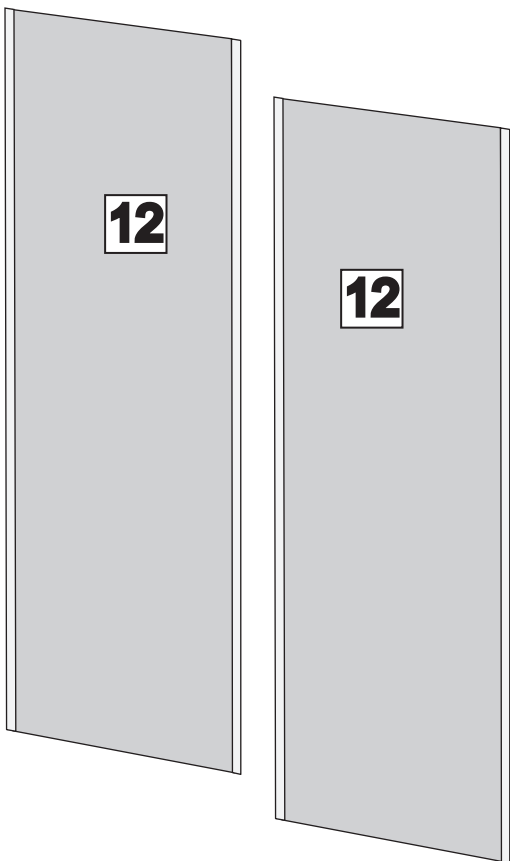
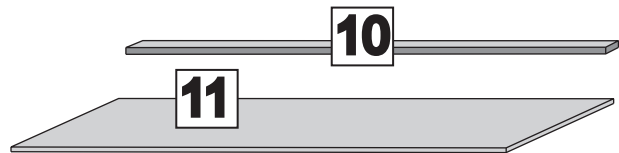
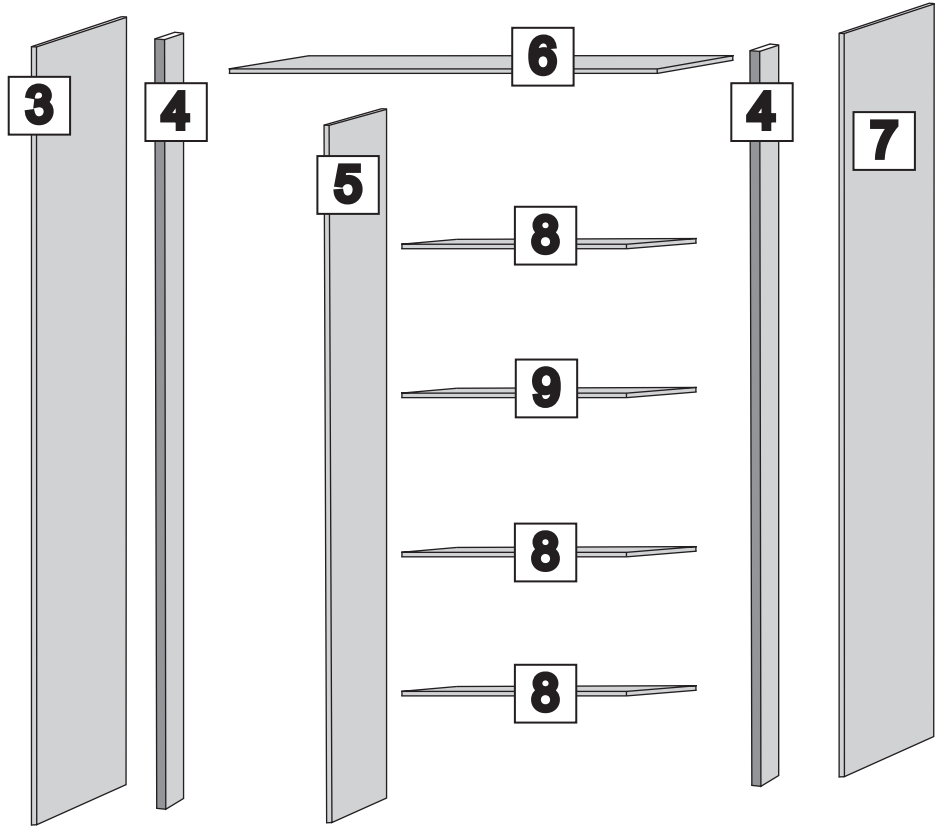
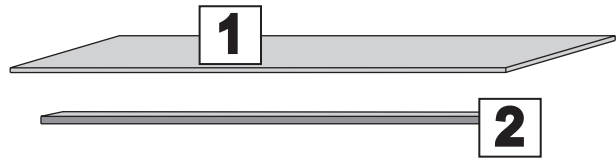

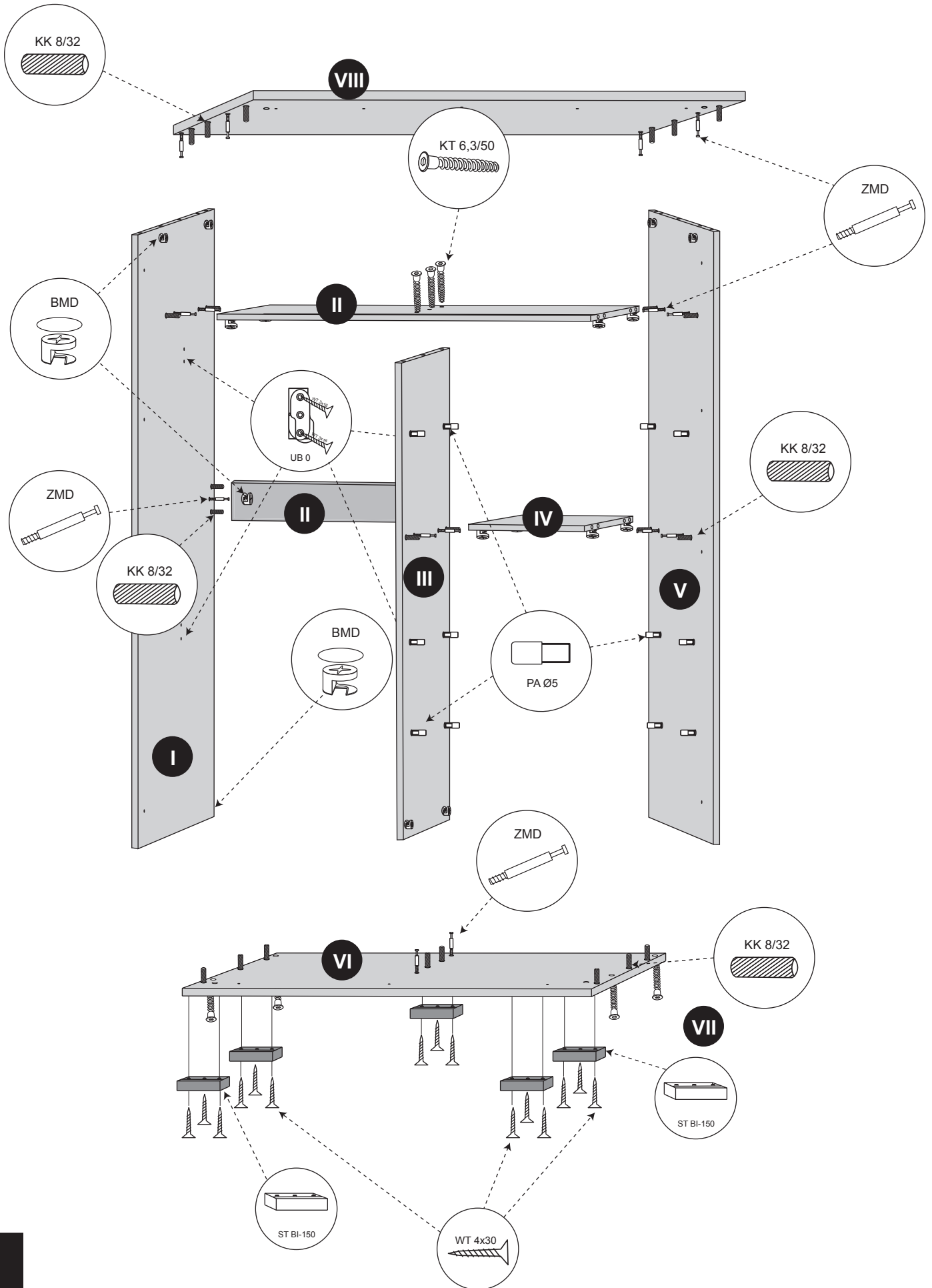

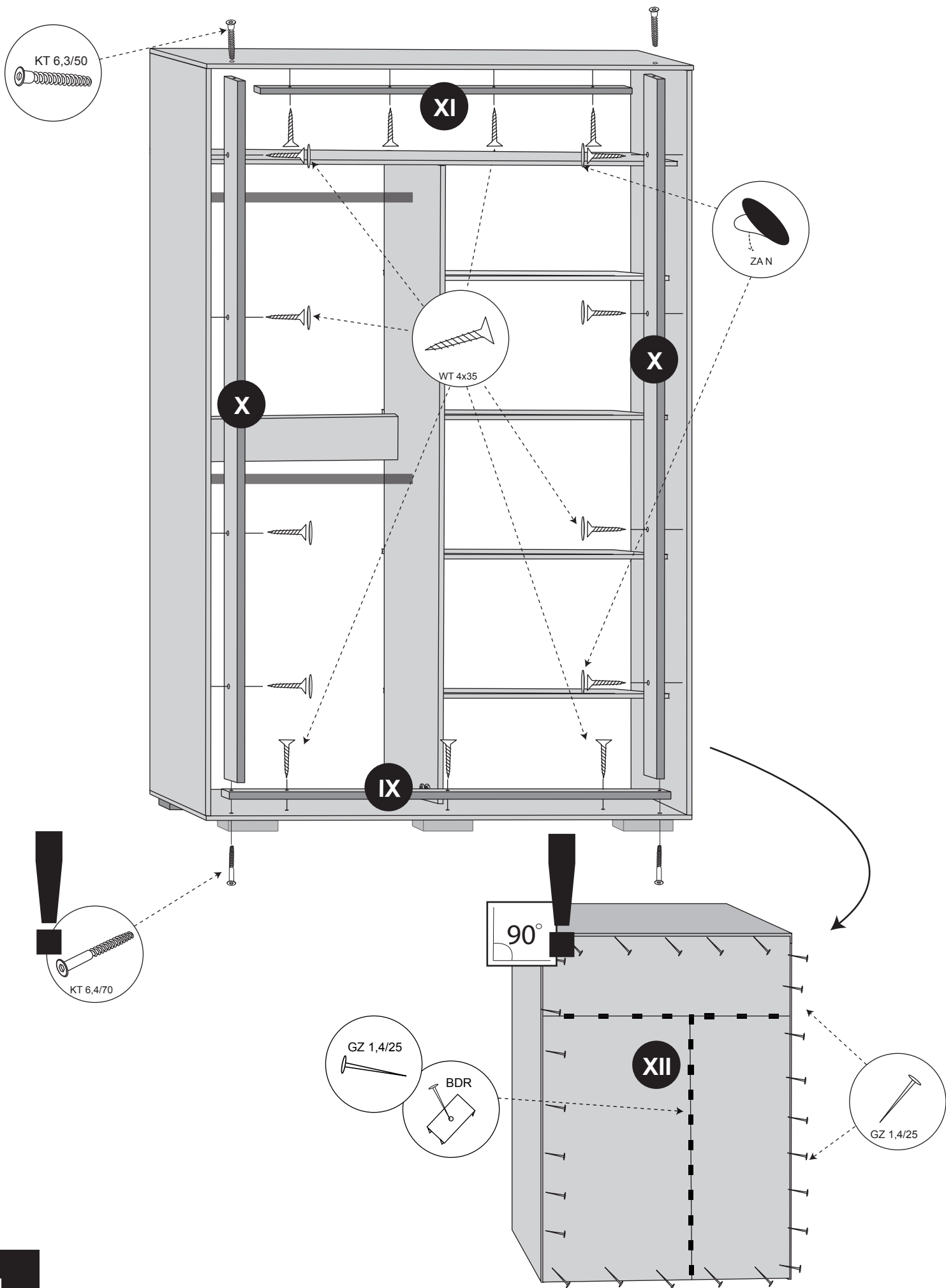

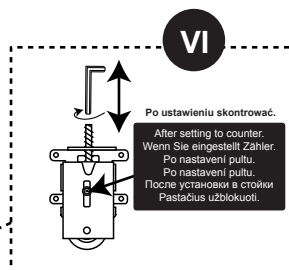
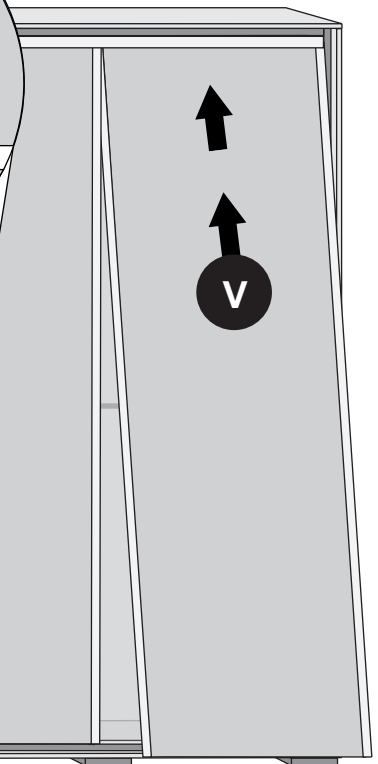
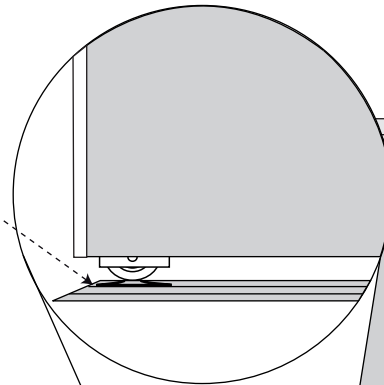
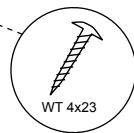
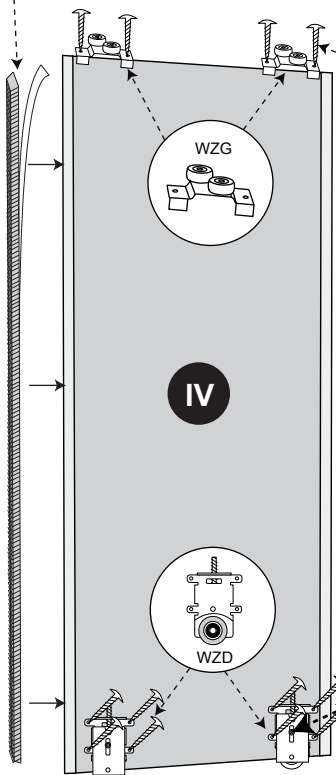
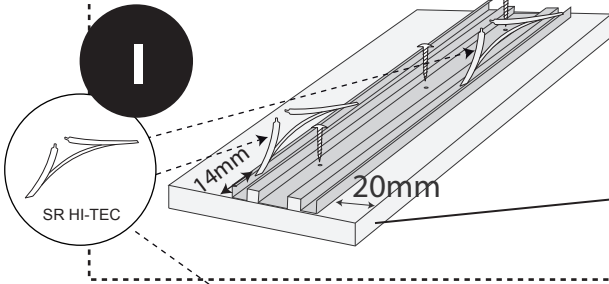
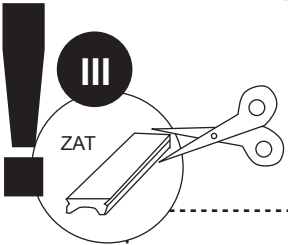
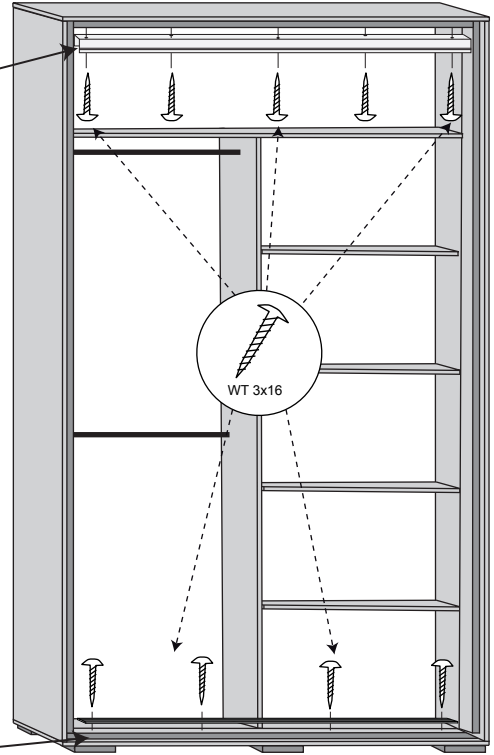
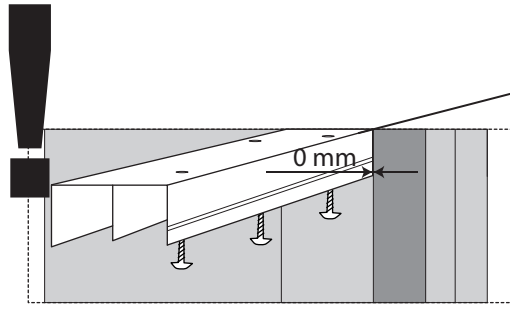
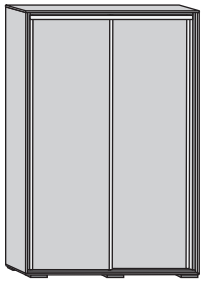

Po ustawieniu skontrolować.
 After setting to counter.
 Wenn Sie eingestellt Zähler.
 Po nastawieni pultu.
 После установовки в стойки
 Растаčius узблукоті.

