

1

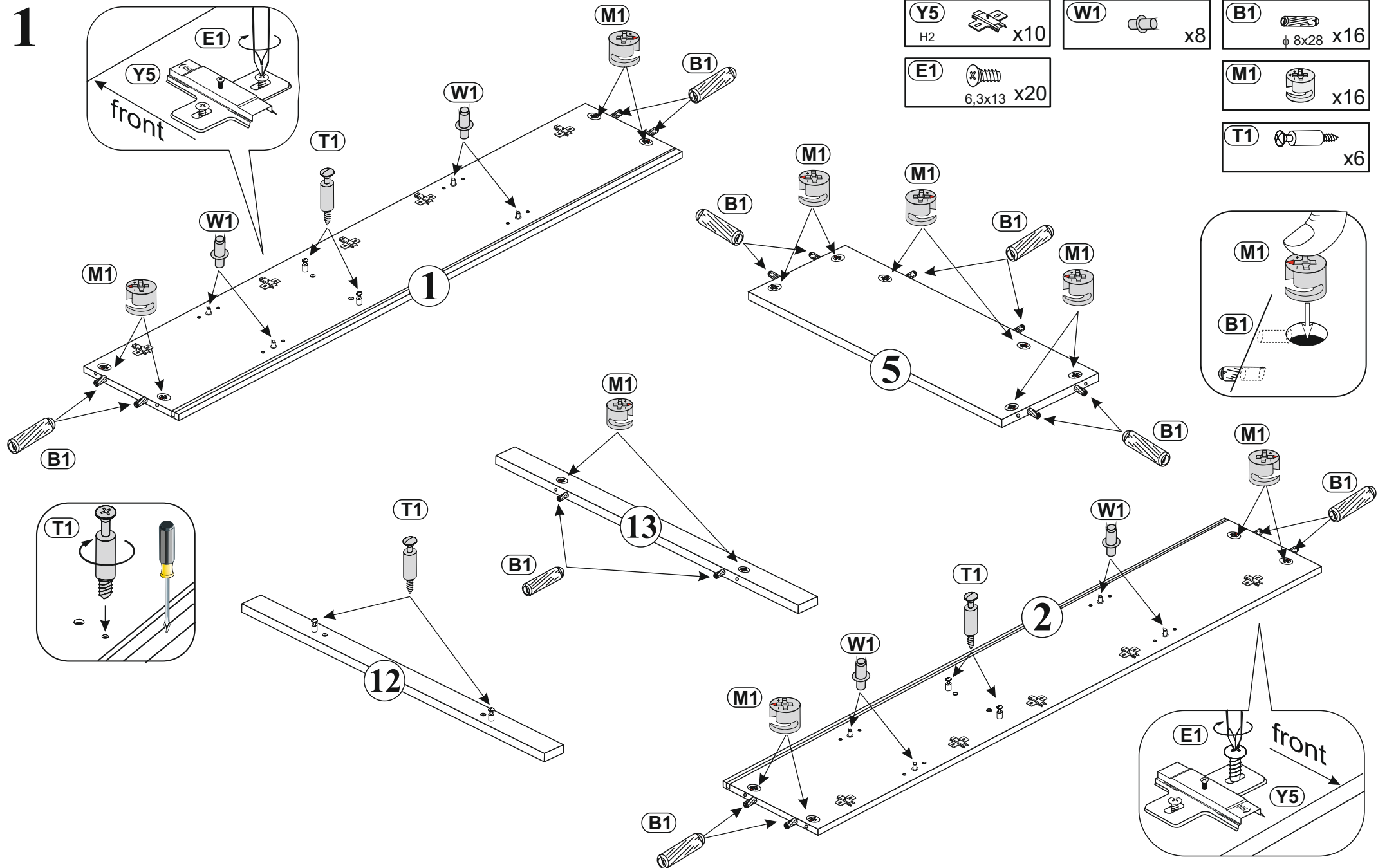

2

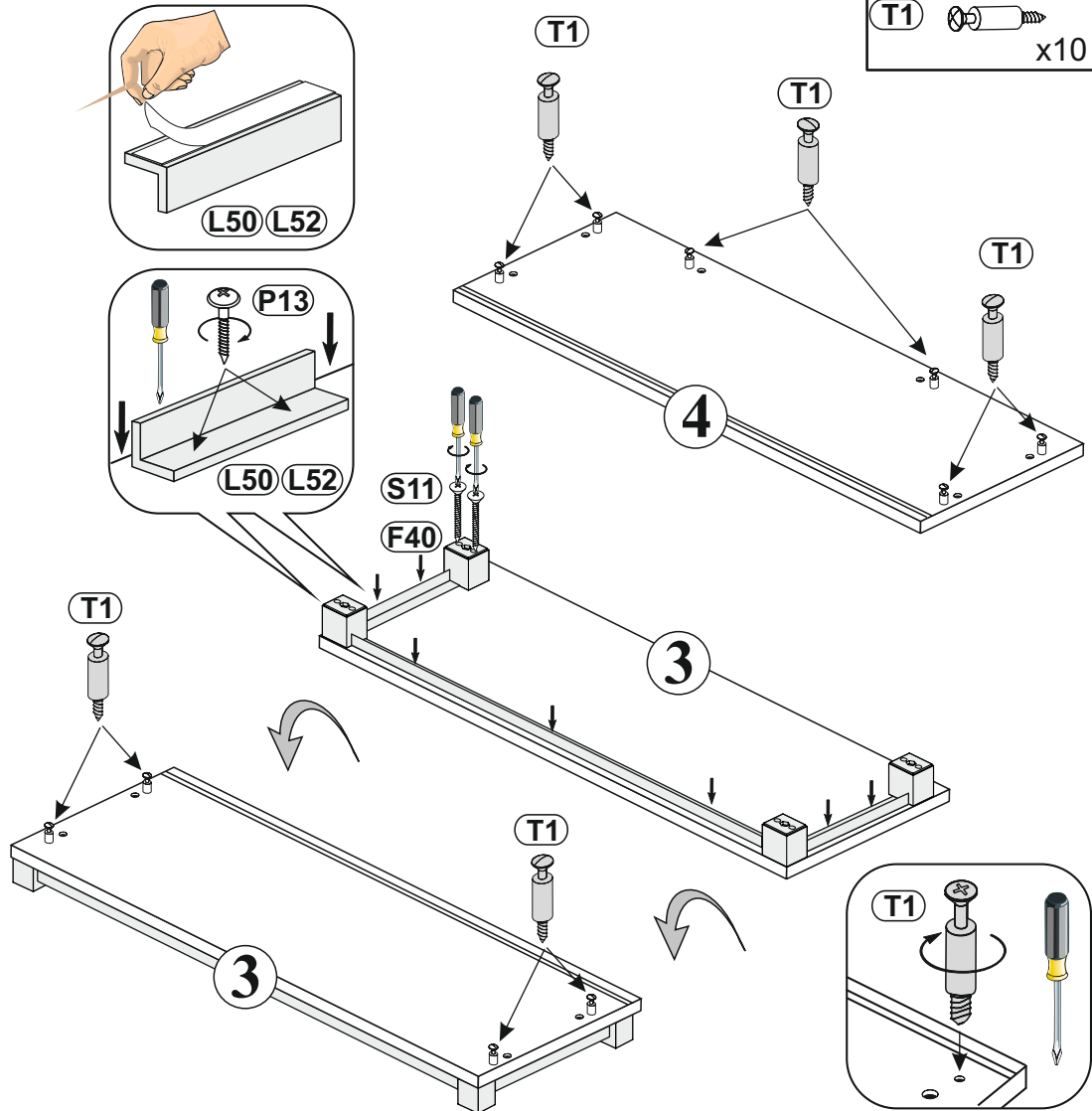
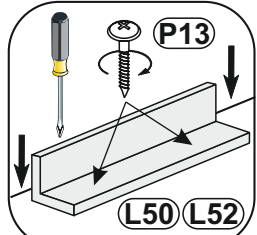
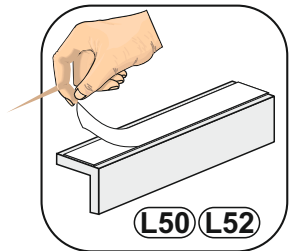
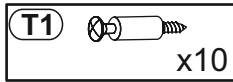
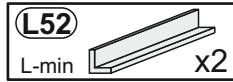
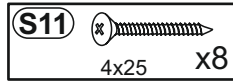
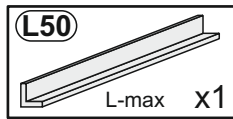
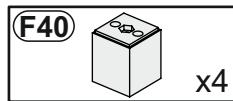
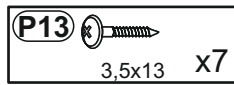

3

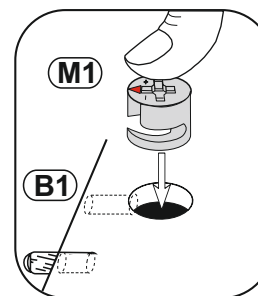
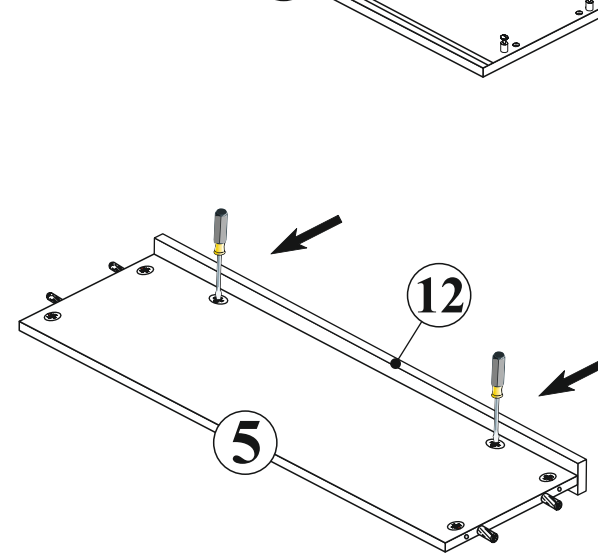
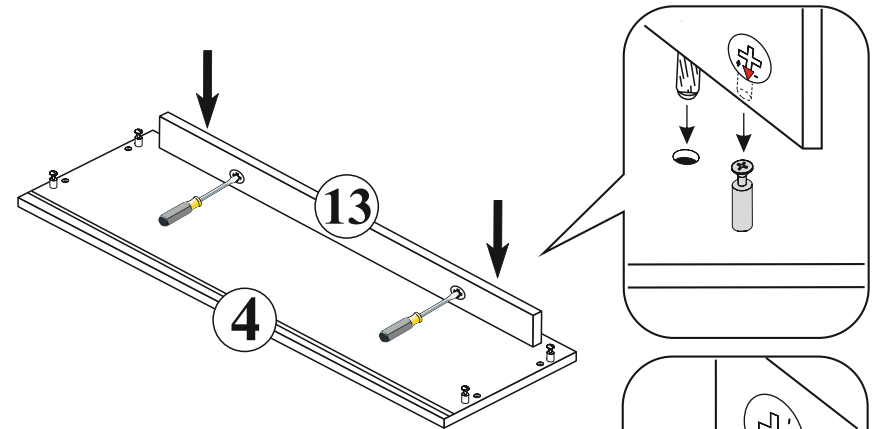

4

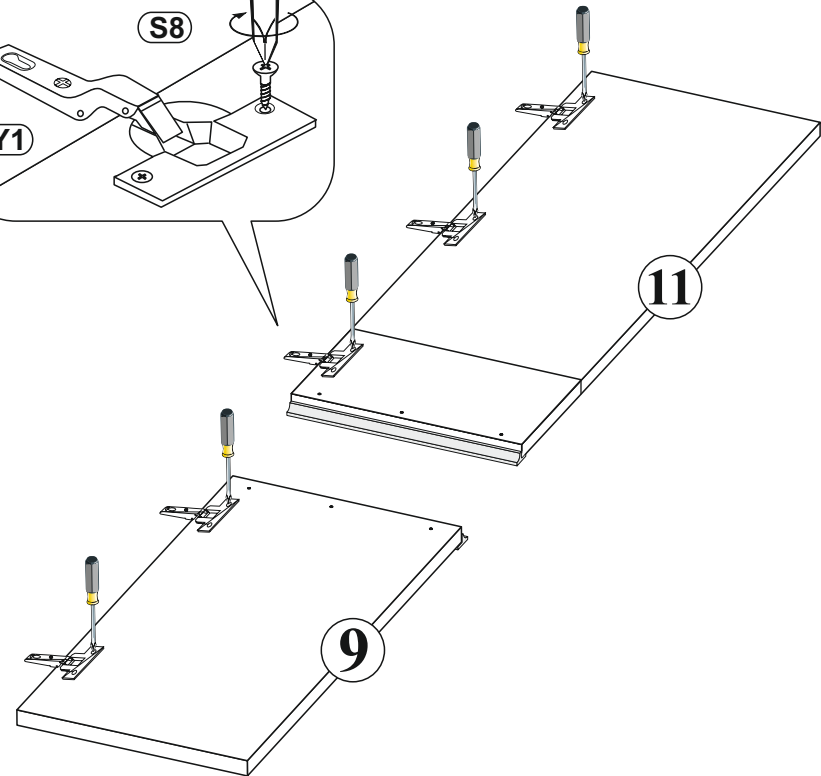
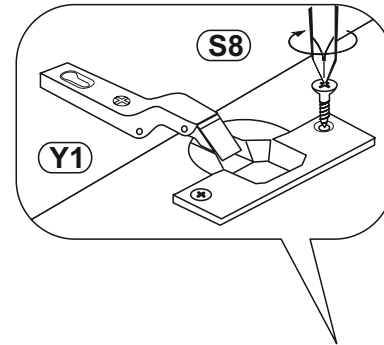
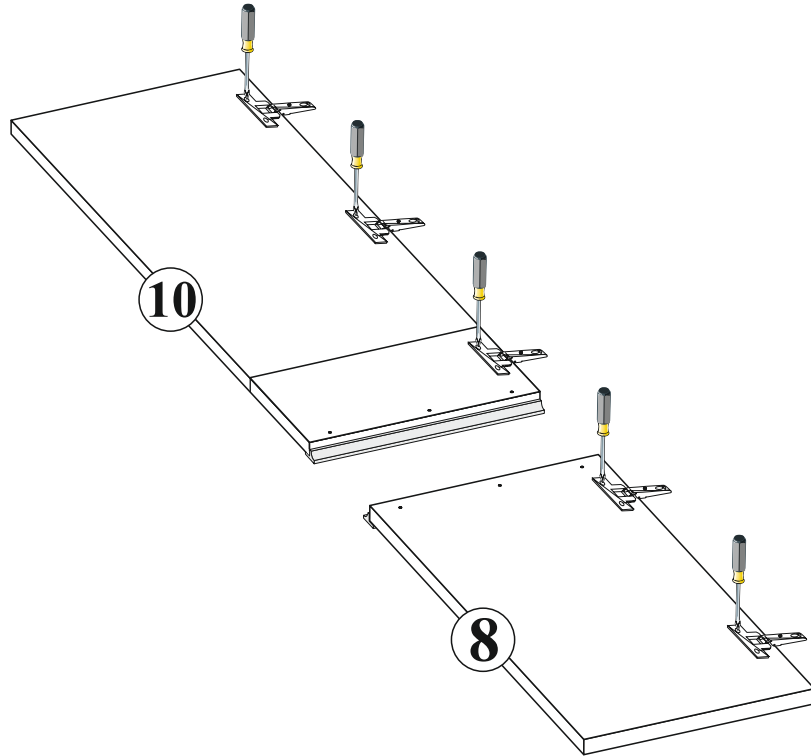
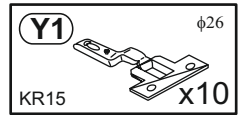
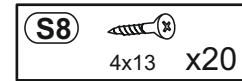

7

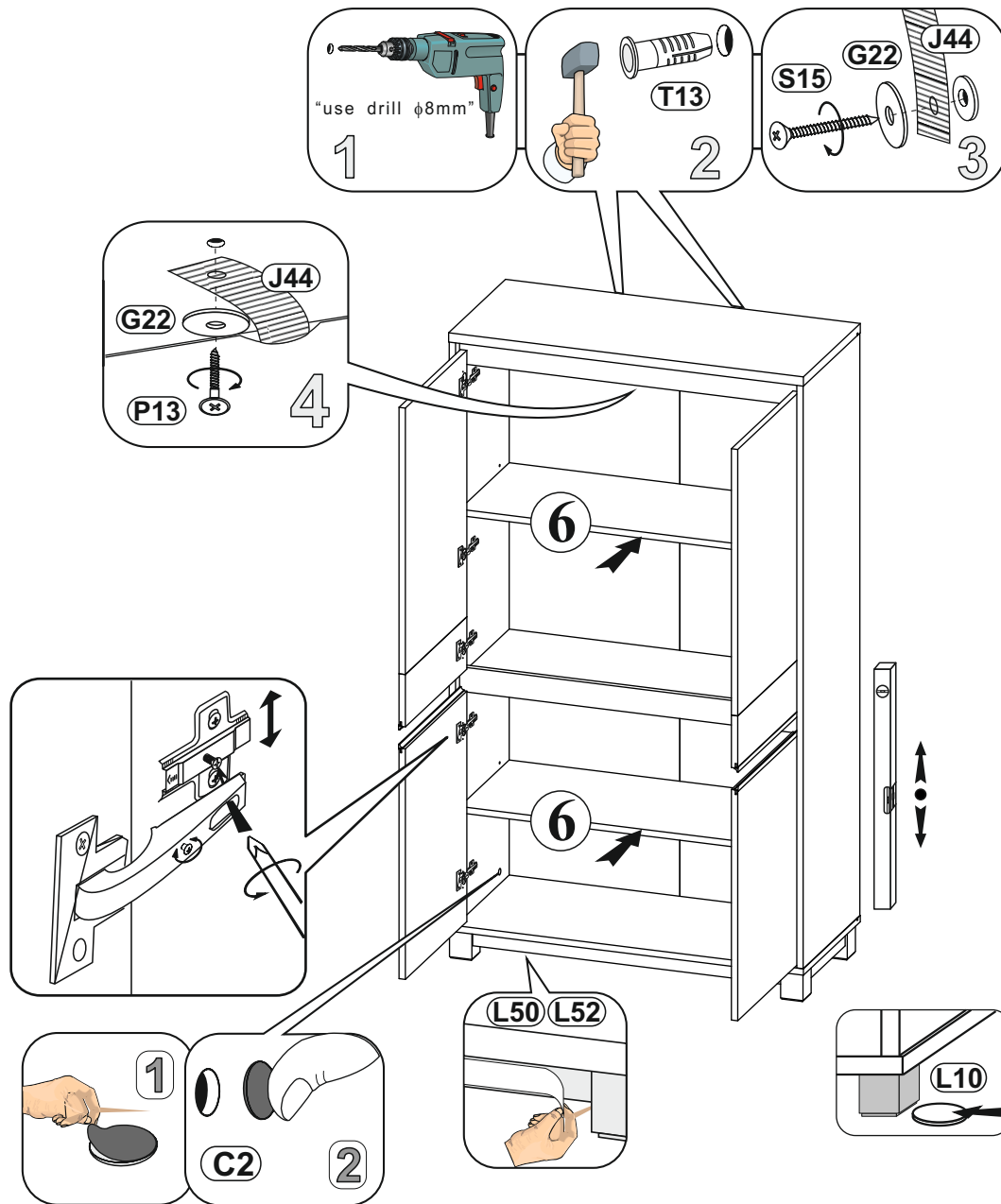

- J44 x2
- T13 $\phi 8$ x2
- S15 4x45 x2
- P13 3,5x13 x2
- G22 $\phi 18$ x4
- L10 x2
- C2 x...(16)

