



VAŽNO – PRE UPOTREBE PAŽLJIVO PROČITAJTE I SAČUVAJTE UPUTSTVO

IMPORTANT – READ CAREFULLY – RETAIN FOR FUTURE REFERENCE

WICHTIG – SORGFÄLTIG LESEN UND AUFBEWAHREN

CZ – MONTÁŽNÍ NÁVOD

WAŽNE – PRZED UŻYCIEM NALEŻY DOKŁADNIE ZAPOZNAĆ SIĘ Z NINIEJSZĄ INSTRUKCJĄ I ZACHOWAĆ JĄ

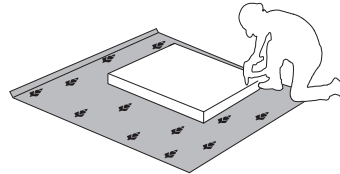
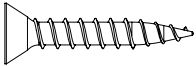
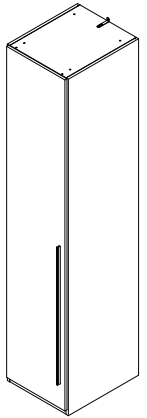

P1/PN
LWH - 468x555x2236
6506 06.09.2019

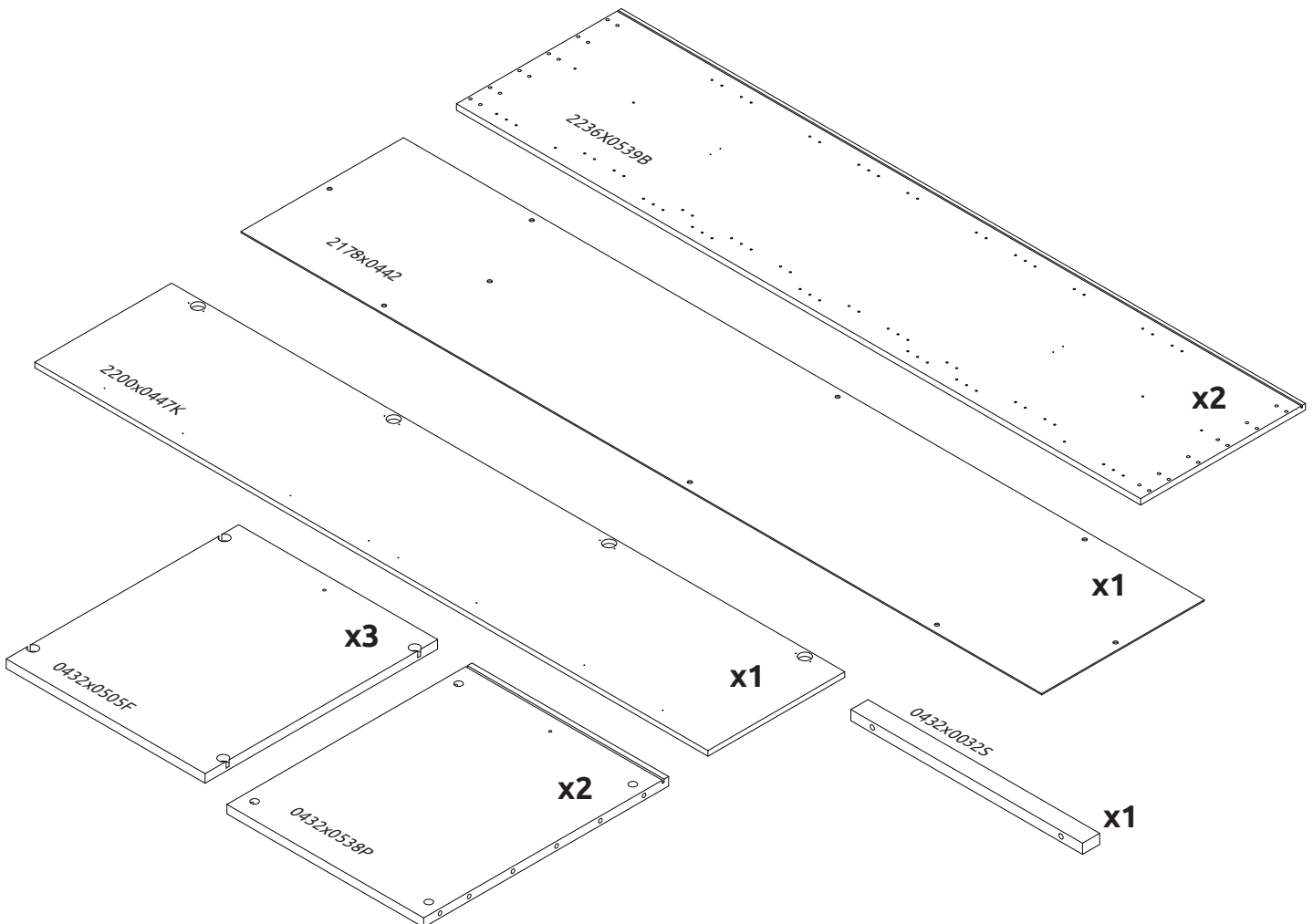
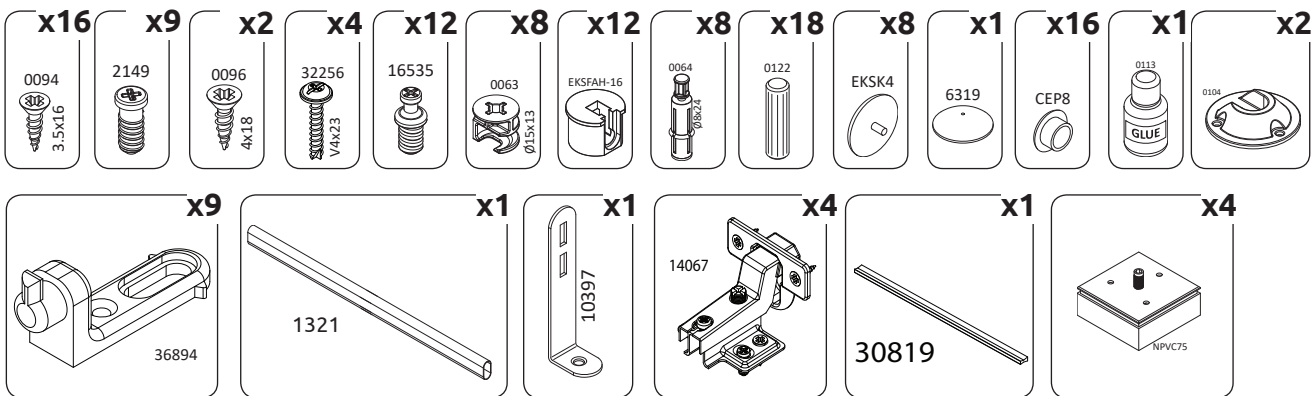

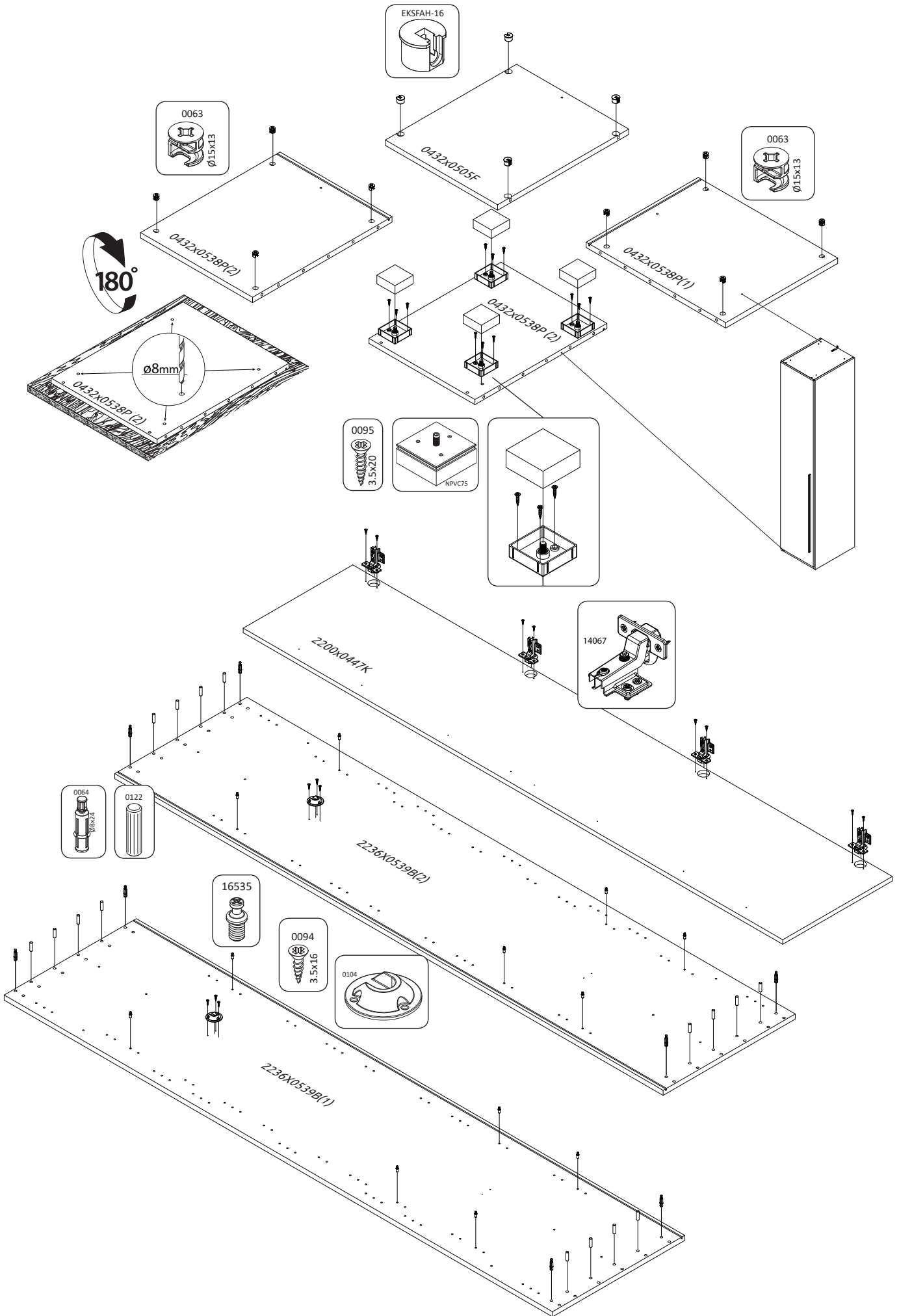

1

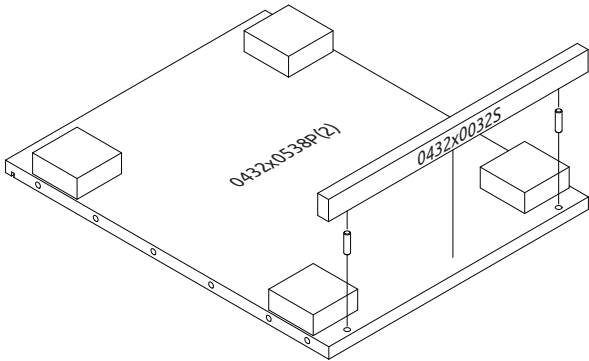
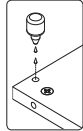
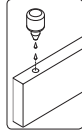
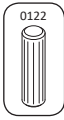

2

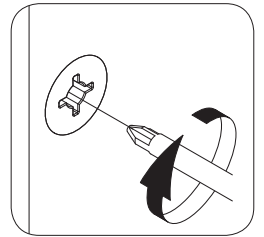
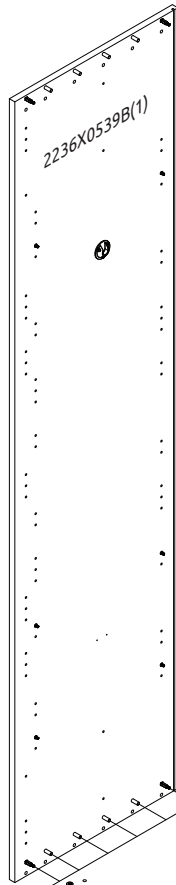

3

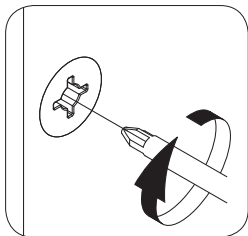
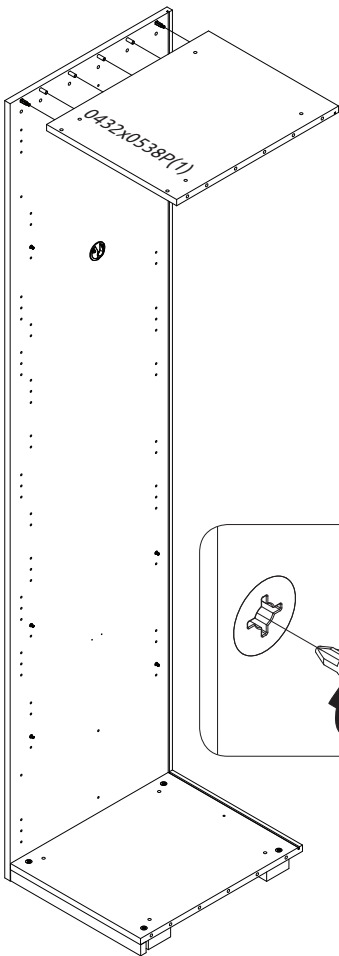

4

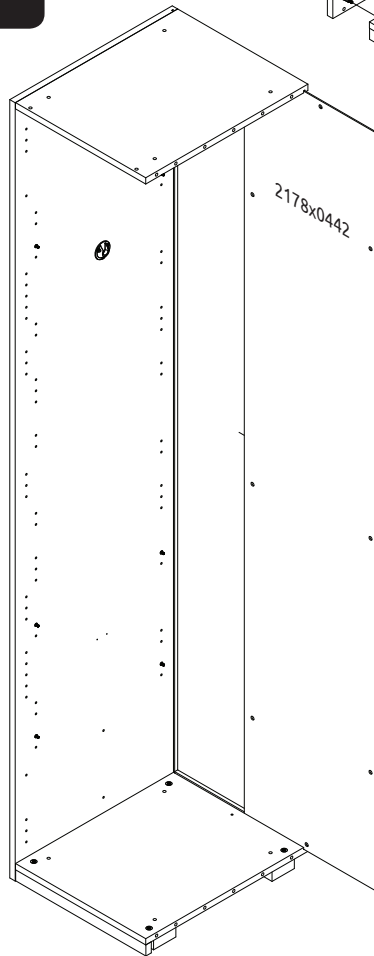

5



*opt 1

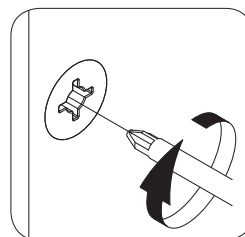
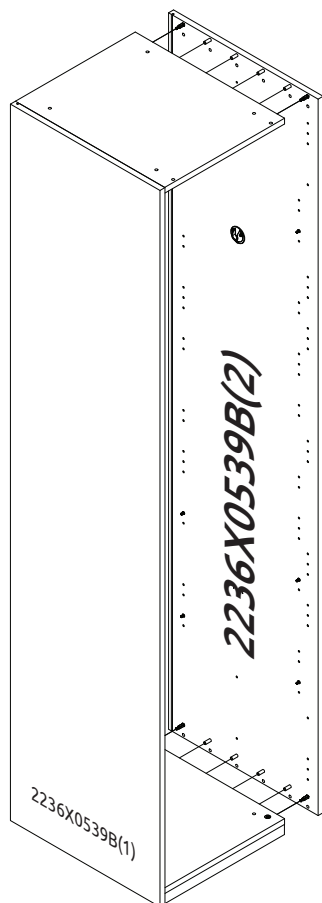
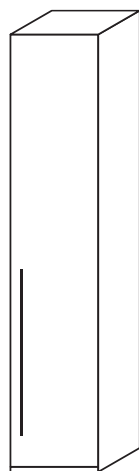

*opt 2

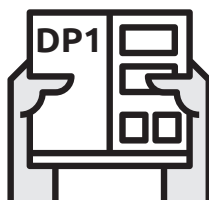
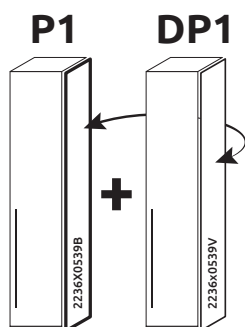

*opt 3

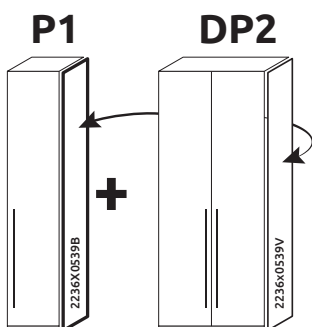

*opt 4

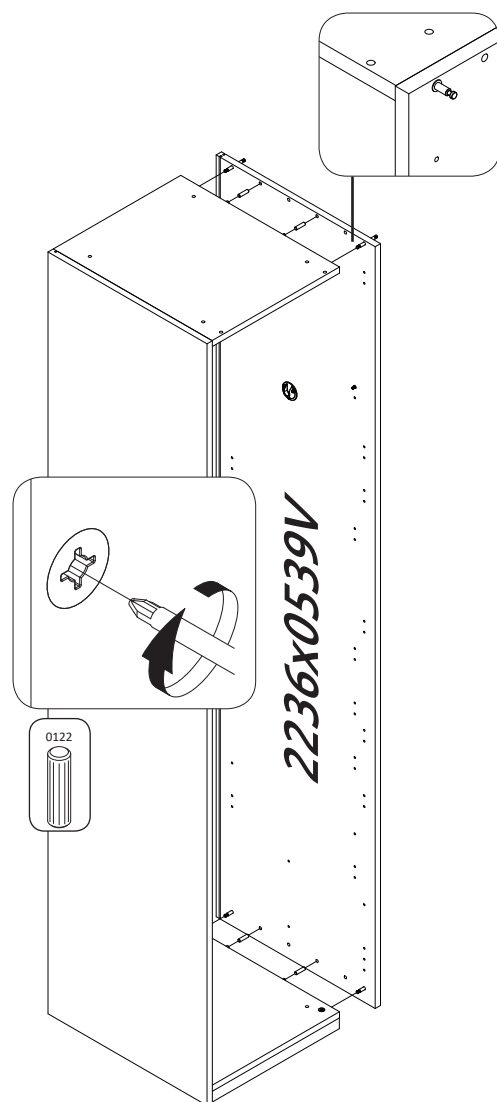
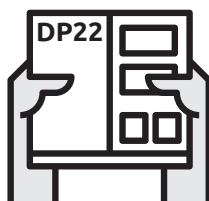
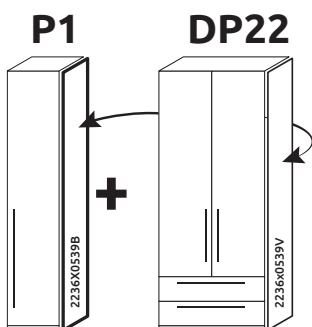

6

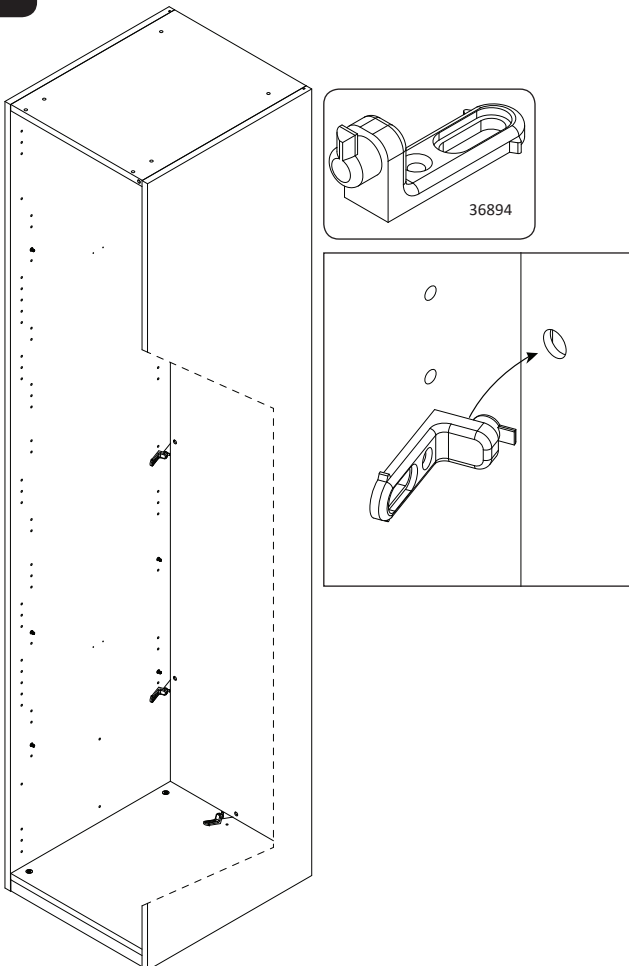

7

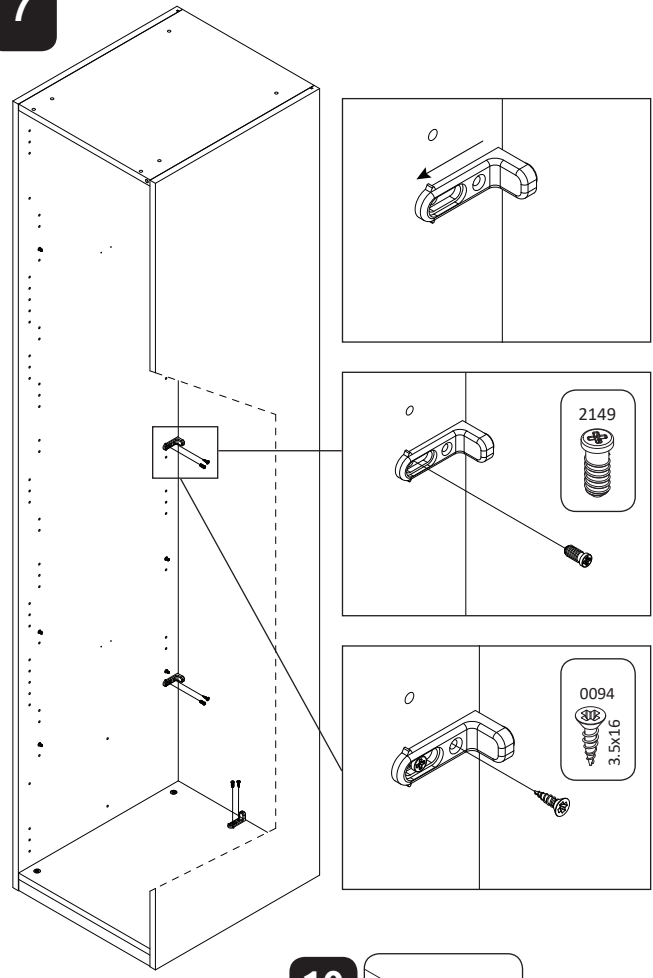

8

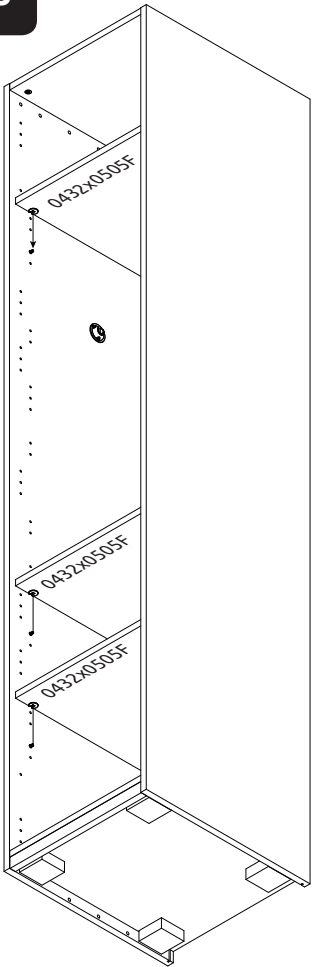

9

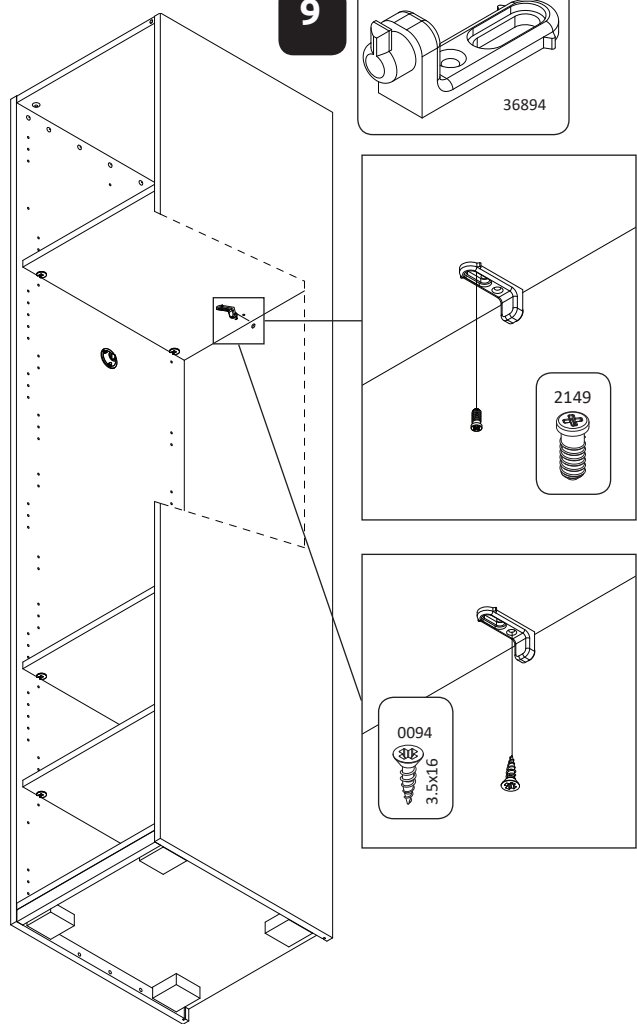

10

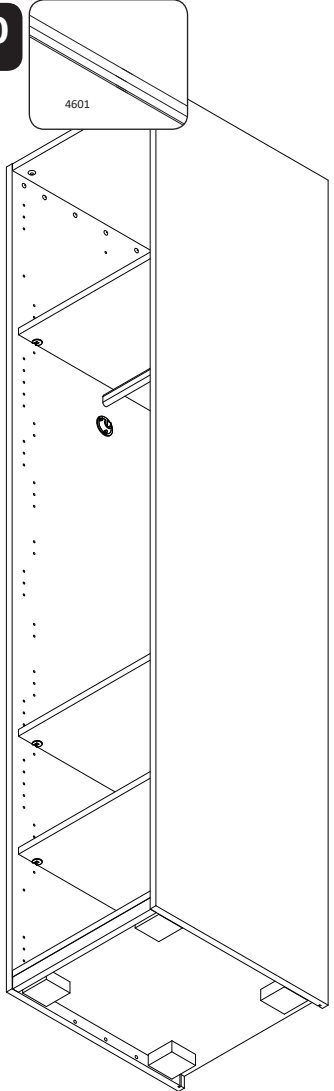

11

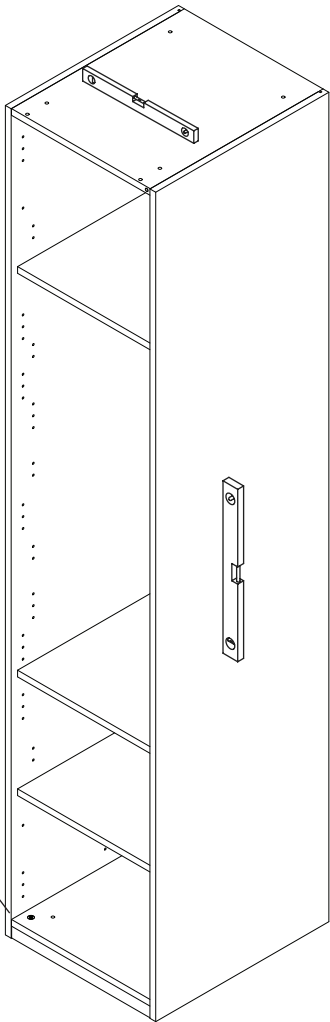
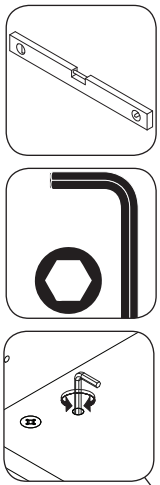

12

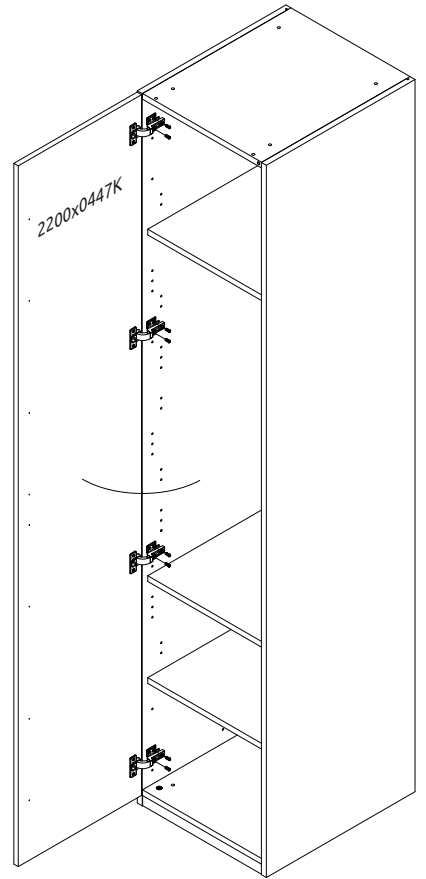
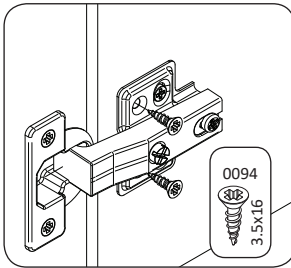
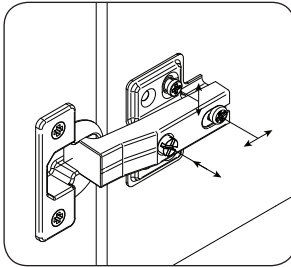
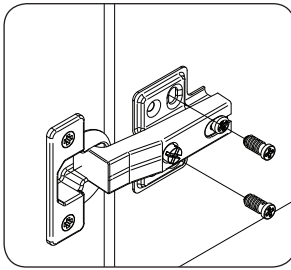

13

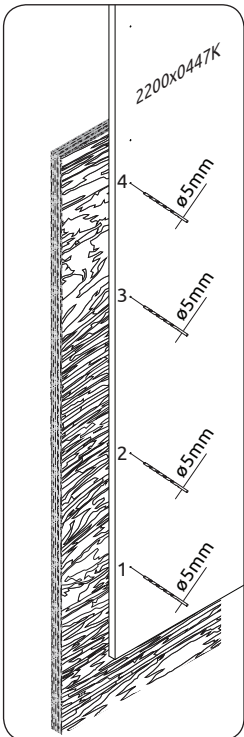

14

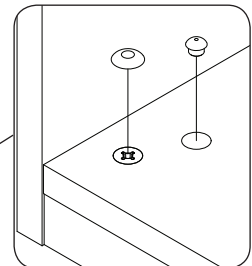
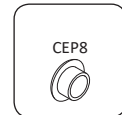
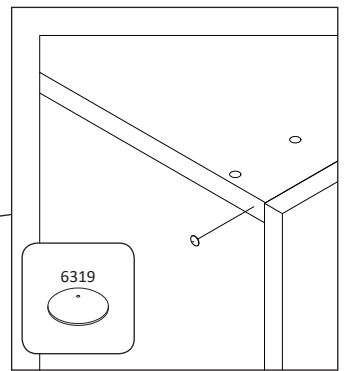
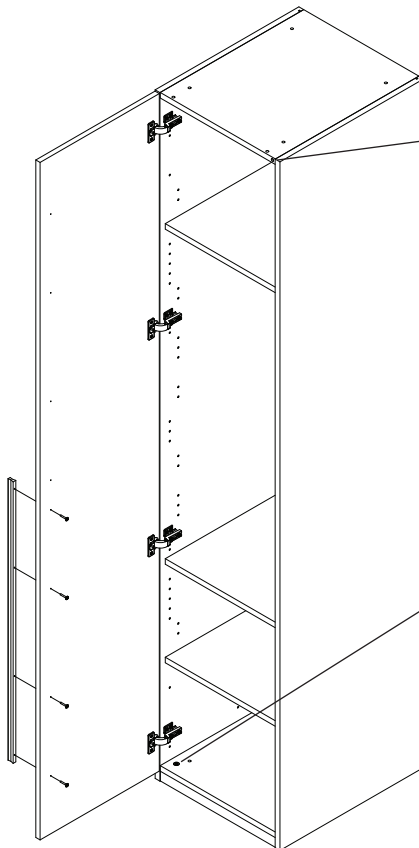
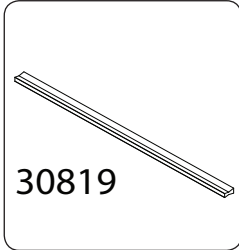

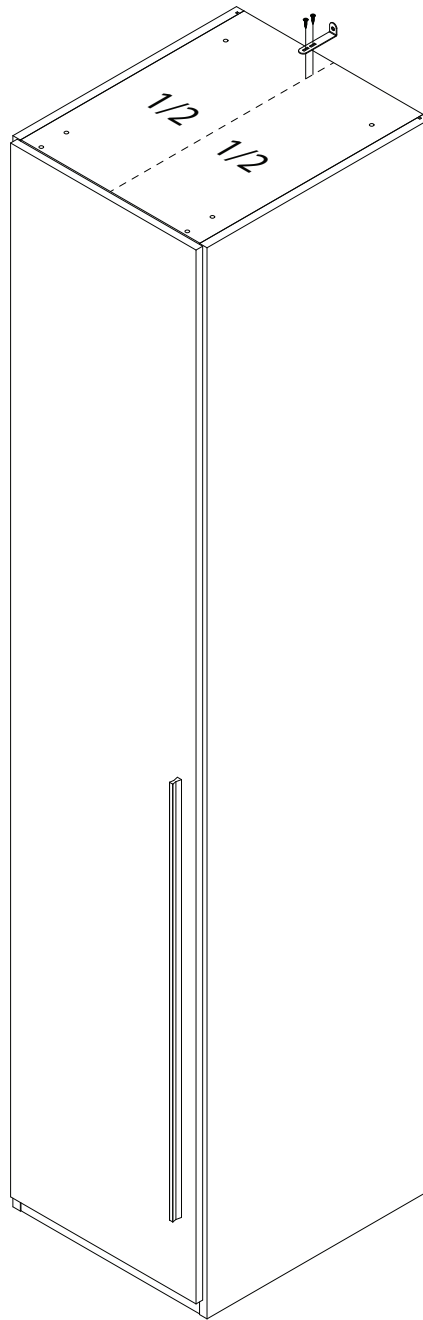
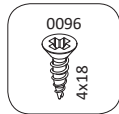
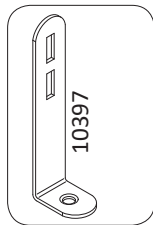
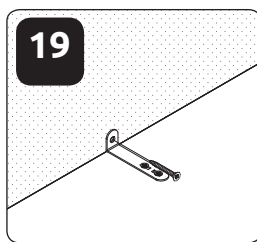
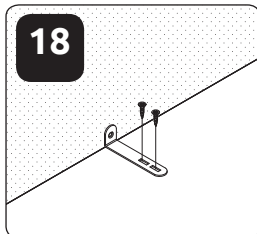
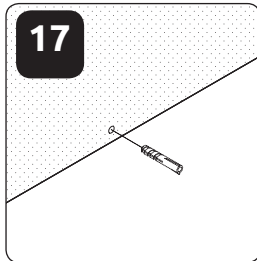
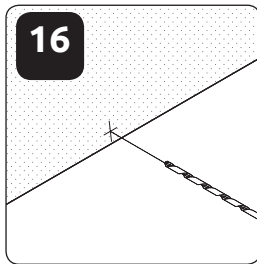
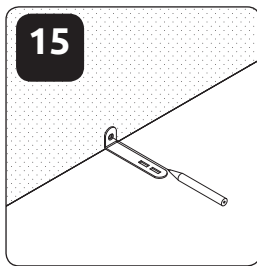

CZ
Důležitá informace
Čtěte pozorně.
Usochevejte tyto informace
pro další použití.

VAROVÁNÍ
Upevňovací prostředky na stěnu nejsou součástí balení, protože různé materiály vyžadují různé typy upevňovacích prostředků. Použijte upevňovací prostředky vhodné pro stěny ve vaší domácnosti. Pro radu ohledně vhodných upevňovacích systémů kontaktujte svého místního specializovaného prodejce.

SRPSKI
Bitno!
Pažljivo pročítajte!
Sačuvajte za ubuduće.

UPOZORENJE!
Nisu dati okovi, tiplovi i šrafovi za pričvršćivanje jer se zidovi razlikuju i različiti materijali zahtevaju i različite okove. Upotrebite one koji su pogodni za zidove u vašem domu. Za savet koje okove da upotrebite, obratite se u lokalnoj gvozdari.

ENGLISH
Important information
Read carefully.
Keep this information for further reference.

WARNING!
Fixing devices for the wall are not included since different wall materials require different types of fixing devices. Use fixing devices suitable for the walls in your home. For advice on suitable fixing systems, contact your local specialized dealer.

DEUTSCH
Wichtige Information Bitte sorgfältig lesen und aufbewahren!

ACHTUNG HINWEIS!
Beschläge für die Wandbefestigung sind nicht beige-packt, da sie von der jeweiligen Wandbeschaffenheit abhängig sind. Benutzen Sie ausschließlich Befestigungsbeschläge, die für die heimischen Wände geeignet sind. Bei diesbezüglichen Fragen ziehen Sie den örtlichen Fachhandel zu Rate.

POLSKI
Ważne!
Uważnie przeczytać!
Zachować do wykorzystania w przyszłości.

OSTRZEŻENIE!
Elementy do mocowania w ścianie: kotwy i wkrety do nich, nie zostały dostarczone w opakowaniu ponieważ ściany są wykonane z różnych materiałów, które wymagają różnych elementów montażowych. Prosimy zakupić i zastosować te, które są odpowiednie do ścian w Państwa mieszkaniu. Aby uzyskać poradę, jakie elementy mocujące zastosować, należy skontaktować się ze sprzedawcami w wyspecjalizowanym sklepie.