

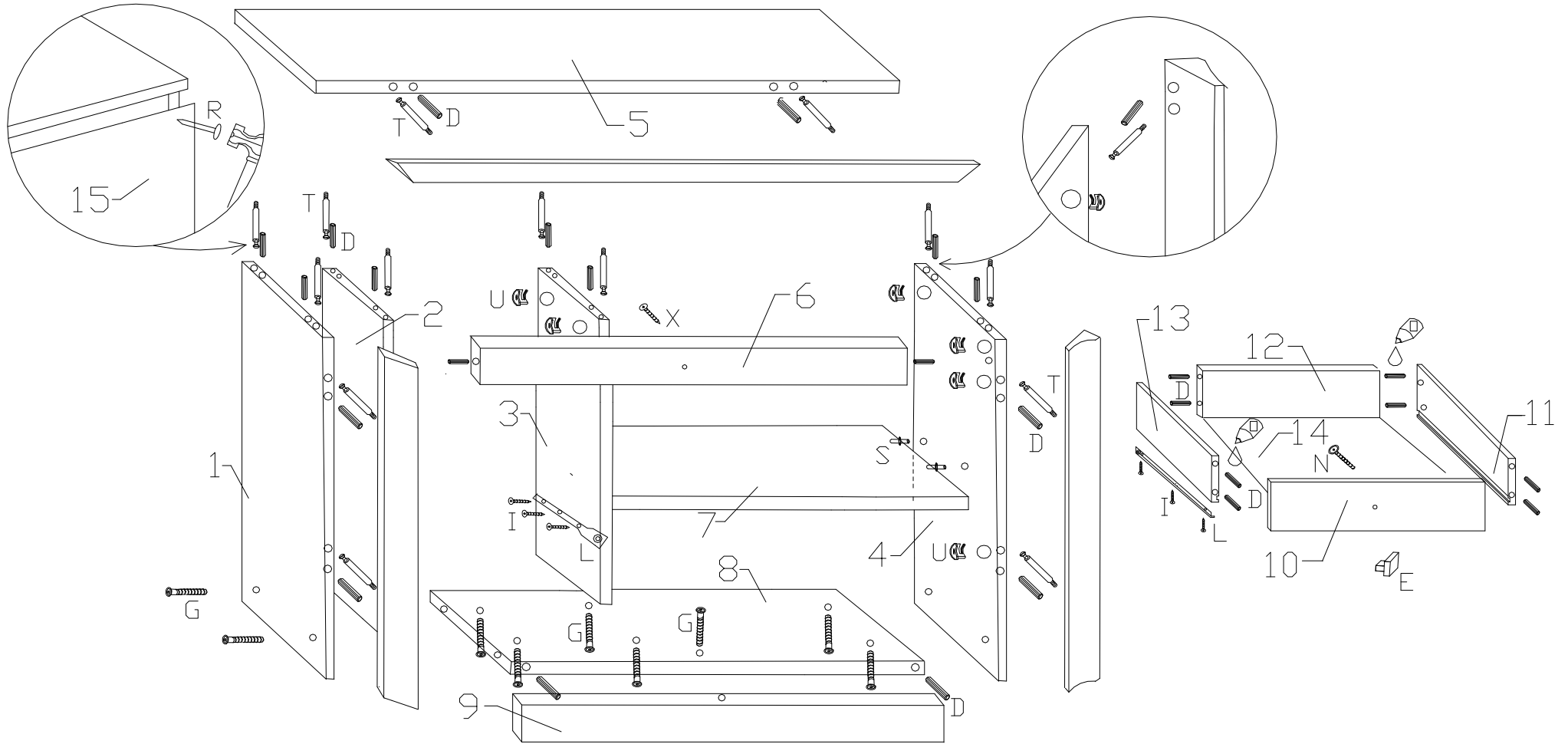













# MARS MR-15

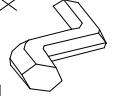

30x R 	11x C 	27x D 	1x E 	14x U 	11x G 7x50 	1x I 	12x 3,5x16 I 
1x 4x25 X 	14x W 	4x S 	1x M 	1x N 	14x T 	1x L 